

Demonstration of the AquaBlok® Sediment Capping Technology

Innovative Technology Evaluation Report



Demonstration of the AquaBlok[®] Sediment Capping Technology

Innovative Technology Evaluation Report

Final

National Risk Management Research Laboratory
Office of Research and Development
U.S. Environmental Protection Agency
Cincinnati, Ohio 45268

Notice

The information in this document has been funded by the U.S. Environmental Protection Agency (EPA) under Contract No. 68-C-00-185 to Battelle Memorial Institute (Battelle). It has been subjected to the Agency's peer and administrative reviews and has been approved for publication as an EPA document. Mention of trade names or commercial products does not constitute an endorsement of recommendation for use.

Foreword

The U.S. Environmental Protection Agency (EPA) is charged by Congress with protecting the Nation's land, air, and water resources. Under a mandate of national environmental laws, the Agency strives to formulate and implement actions leading to a compatible balance between human activities and the ability of natural systems to support and nurture life. To meet this mandate, EPA's research program is providing data and technical support for solving environmental problems today and building a science knowledge base necessary to manage our ecological resources wisely, understand how pollutants affect our health, and prevent or reduce environmental risks in the future.

The National Risk Management Research Laboratory (NRMRL) is the Agency's center for investigation of technological and management approaches for reducing risks from threats to human health and the environment. The focus of the Laboratory's research program is on methods for the prevention and control of pollution to air, land, water and subsurface resources; protection of water quality in public water systems; remediation of contaminated sites and ground water; and prevention and control indoor air pollution. The goal of this research effort is to catalyze development and implementation of innovative, cost-effective environmental technologies; develop scientific and engineering information needed by EPA to support regulatory and policy decisions; and provide technical support and information transfer to ensure effective implementation of environmental regulations and strategies.

This publication has been produced as part of the Laboratory's strategic long-term research plan. It is published and made available by EPA's Office of Research and Development (ORD) to assist the user community and to link researchers with their clients.

Sally Gutierrez, Director
National Risk Management Research Laboratory

Abstract

AquaBlok® is an innovative, proprietary clay polymer composite developed by AquaBlok, Ltd. of Toledo, OH, and represents an alternative to traditional sediment capping materials such as sand. It is designed to swell and form a continuous and highly impermeable isolation barrier between contaminated sediments and the overlying water column, and claims superior impermeability, stability, and erosion resistance and general cost-competitiveness relative to more traditional capping materials. AquaBlok® is generally marketed as a non-specific capping material that could encapsulate any class or type of contaminant as well as theoretically any range of contaminant concentration. Although there is claimed to be no practicable limit to the depth at which the material would function, AquaBlok® is typically formulated to function in relatively shallow, freshwater to brackish, generally nearshore environments and is commonly comprised of bentonite clay with polymer additives covering a small aggregate core. In addition, other specific formulations of AquaBlok® are available, including varieties that can function in saline environments and advanced formulations that incorporate treatment reagents to actively treat or sequester sediment contaminants or plant seeds to promote the establishment or regrowth of vegetated habitat.

Under the U.S. Environmental Protection Agency (EPA) Superfund Innovative Technology Evaluation (SITE) Program, the effectiveness of AquaBlok® as an innovative contaminated sediment capping technology was evaluated in the Anacostia River in Washington, DC. Sediments in the Anacostia River are contaminated with polycyclic aromatic hydrocarbons (PAHs), polychlorinated biphenyls (PCBs), heavy metals, and other chemicals to levels that have hindered commercial, industrial, and recreational uses. The performance of AquaBlok® was assessed through the SITE demonstration by monitoring an AquaBlok® cap over an approximately three year period using a multitude of invasive and/or non-invasive sampling and monitoring tools. The performance of AquaBlok® was compared to the performance of a traditional sand cap relative to three fundamental study objectives, and control sediments were also monitored to provide critical context to the data evaluations. Specifically, the study objectives were to determine the physical stability of AquaBlok® relative to the traditional sand cap material, the ability of AquaBlok® to prevent hydraulic seepage relative to traditional sand cap material, and the impact of AquaBlok® on benthic habitat and ecology relative to traditional sand cap material and conditions in the native river system.

There were field data collection issues and inherent data uncertainties within the SITE demonstration that limit the usefulness of certain data and minimize the power of certain evaluations and interpretations, and the conclusions of the demonstration must be reviewed in this context. However, the overall results of the AquaBlok® SITE demonstration indicate that the AquaBlok® material is highly stable, and likely more stable than traditional sand capping material even under very high bottom shear stresses. The AquaBlok® material is also characteristically more impermeable, and the weight of evidence gathered suggests it is potentially more effective at controlling contaminant flux, than traditional sand capping material. AquaBlok® also appears to be characterized by impacts to benthos and benthic habitat generally similar to traditional sand capping material.

Table of Contents

Foreword	iii
Abstract	iv
Appendices	ix
Figures	x
Tables	xi
Acronyms, Abbreviations, and Symbols	xii
Acknowledgements	xvi
Section 1: Introduction	1
1.1 Description of the SITE Program and SITE Reports	1
1.1.1 Purpose, History, and Goals of the SITE Program	1
1.1.2 Documentation of SITE Program Results	2
1.1.2.1 Purpose and Organization of the ITER.....	2
1.2 AquaBlok® General Technology Description	3
1.3 Key Contacts	4
Section 2: Technology Applications Analysis	6
2.1 Key Technology Features.....	6
2.2 Applicable Wastes	7
2.3 Technology Operability, Availability, and Transportability.....	7
2.4 Range of Suitable Site Characteristics	8
2.5 Site Support Requirements	9
2.6 Material Handling and Quality Control Requirements.....	10
2.7 Technology Limitations.....	10
2.8 Factors Affecting Performance	12
2.9 Site Reuse.....	13
2.10 Feasibility Study Evaluation Criteria	13
2.10.1 Overall Protection of Human Health and the Environment	13
2.10.2 Compliance with Applicable or Relevant and Appropriate Requirements	14
2.10.3 Long-Term Effectiveness and Permanence.....	14
2.10.4 Reduction of Toxicity, Mobility, and Volume through Treatment.....	15
2.10.5 Short-Term Effectiveness	15
2.10.6 Implementability.....	16
2.10.7 Cost	16
2.10.8 State Acceptance.....	16
2.10.9 Community Acceptance	16
2.11 Permitting	17

Section 3: Technology Effectiveness	19
3.1 AquaBlok® SITE Demonstration Program Description.....	19
3.1.1 AquaBlok® SITE Demonstration Study Area Description.....	21
3.1.1.1 Physical and Chemical Setting of AquaBlok® SITE Demonstration	21
3.1.1.2 AquaBlok® SITE Demonstration Cap Design and Construction	21
3.2 AquaBlok® SITE Demonstration Approach and Methods	27
3.2.1 Critical and Non-Critical Measurements	28
3.2.2 Field Activities.....	30
3.2.3 Field Measurement Tools	31
3.2.3.1 Sedflume Coring and Analysis	31
3.2.3.2 Sediment Coring and Analysis of Contaminants of Concern.....	34
3.2.3.3 Bathymetry and Sub-Bottom Profiling	35
3.2.3.4 Side-Scan Sonar	35
3.2.3.5 Sediment Profile Imaging	35
3.2.3.6 Gas Flux Analysis.....	37
3.2.3.7 Sediment Coring and Analysis of Physical Parameters.....	39
3.2.3.8 Sediment Coring and Analysis of Hydraulic Conductivity	39
3.2.3.9 Seepage Meter Testing	39
3.2.3.10 Benthic Grab Sampling and Descriptive and Statistical Benthic Assays.....	41
3.2.3.11 Benthic Assessment through Sediment Profile Imaging.....	42
3.2.4 AquaBlok® SITE Demonstration Specific Approach and Methods.....	43
3.2.4.1 One-Month Post-Capping Field Event.....	43
3.2.4.1.1 One-Month Post-Capping Field Event Bathymetry and Sub-Bottom Profiling	43
3.2.4.1.2 One-month Post-Capping Field Event Side-Scan Sonar Surveying.....	44
3.2.4.1.3 One-Month Post-Capping Field Event Sediment Profile Imaging.	44
3.2.4.1.4 One-Month Post-Capping Field Event Seepage Meter Testing.	46
3.2.4.2 Six-Month Post-Capping Field Event.....	46
3.2.4.2.1 Six-Month Post-Capping Field Event Bathymetry and Sub-bottom Profiling.....	46
3.2.4.2.2 Six-Month Post-Capping Field Event Sediment Profile Imaging.	47
3.2.4.2.3 Six-Month Post-Capping Field Event Seepage Meter Testing.	47
3.2.4.2.4 Six-Month Post-Capping Field Event Sedflume Coring and Analysis.	47
3.2.4.2.5 Six-Month Post-Capping Field Event Sediment Coring and Analysis of Contaminants of Concern and Physical Parameters.	48
3.2.4.3 18-Month Post-Capping Field Event.....	50
3.2.4.3.1 18-Month Post-Capping Field Event Bathymetry and Sub-bottom Profiling.....	50

3.2.4.3.2	18-Month Post-Capping Field Event Side-Scan Sonar Surveying.....	50
3.2.4.3.3	18-Month Post-Capping Field Event Sediment Profile Imaging.	50
3.2.4.3.4	18-Month Post-Capping Field Event Seepage Meter Testing.	51
3.2.4.3.5	18-Month Post-Capping Field Event Sediment Coring and Analysis of Contaminants of Concern, Physical Parameters, and Hydraulic Conductivity.	51
3.2.4.3.6	18-Month Post-Capping Field Event Gas Flux Analysis.....	52
3.2.4.4	30-Month Post-Capping Field Event.....	53
3.2.4.4.1	30-Month Post-Capping Field Event Bathymetry and Sub-Bottom Profiling.	53
3.2.4.4.2	30-Month Post-Capping Field Event Side-Scan Sonar Surveying.....	53
3.2.4.4.3	30-Month Post-Capping Field Event Sediment Profile Imaging.	54
3.2.4.4.4	30-Month Post-Capping Field Event Seepage Meter Testing.	54
3.2.4.4.5	30-Month Post-Capping Field Event Sedflume Analysis.....	54
3.2.4.4.6	30-Month Post-Capping Field Event Sediment Coring and Analysis of Contaminants of Concern, Physical Parameters, and Hydraulic Conductivity.	55
3.2.4.4.7	30-Month Post-Capping Field Event Gas Flux Analysis.....	56
3.2.4.4.8	30-Month Post-Capping Field Event Benthic Grab Sampling and Descriptive and Statistical Benthic Assays.....	57
3.2.4.5	General AquaBlok® SITE Demonstration Quality Assurance and Quality Control.....	58
3.3	AquaBlok® SITE Demonstration Results.....	59
3.3.1	Objective #1 – Physical Stability of An AquaBlok® Cap	59
3.3.1.1	Objective #1 Results – Critical Measurements	64
3.3.1.1.1	Sedflume Coring and Analysis	64
3.3.1.1.2	Sediment Coring and Analysis of Contaminants of Concern.....	66
3.3.1.1.3	Bathymetry and Sub-Bottom Profiling	78
3.3.1.1.4	Side-Scan Sonar Surveying	82
3.3.1.2	Objective #1 Results – Non-Critical Measurements	85
3.3.1.2.1	Sediment Profile Imaging	85
3.3.1.2.2	Gas Flux Analysis.....	86
3.3.1.2.3	Sediment Coring and Analysis of Physical Parameters.....	92
3.3.2	Objective #2 – Ability of An AquaBlok® Cap to Control Groundwater Seepage	94

3.3.2.1	Objective #2 Results – Critical Measurements	94
3.3.2.1.1	Sediment Coring and Analysis of Hydraulic Conductivity.....	94
3.3.2.1.2	Seepage Meter Testing	96
3.3.2.2	Objective #2 Results – Non-critical Measurements	105
3.3.2	Objective #3 – The Influence of An AquaBlok® Cap on Benthic Flora and Fauna	105
3.3.3.1	Objective #3 Results – Critical Measurements	106
3.3.3.2	Objective #3 Results – Non-Critical Measurements	106
3.3.3.2.1	Benthic Grab Sampling and Descriptive and Statistical Benthic Assays	106
3.3.3.2.2	Benthic Assessment Through Sediment Profile Imaging	107
Section 4:	Economic Analysis	113
4.1	SITE Demonstration Pilot-Scale AquaBlok® Capping Costs	113
4.1.1	SITE Demonstration As-Built AquaBlok® Cap.....	113
4.1.2	SITE Demonstration AquaBlok® Pilot Costs	115
4.2	Full-Scale AquaBlok® Application	115
4.2.1	Site-Specific Factors Affecting Cost.....	115
4.2.2	Issues and Assumptions.....	116
4.2.3	Full-Scale AquaBlok® Application Cost Categories.....	117
4.2.3.1	General Cost Categories.....	117
4.2.3.1.1	Local AquaBlok® Manufacture Costs	117
4.2.3.1.2	AquaBlok® Cap Installation Costs.....	117
4.2.3.1.3	Construction Quality Control and Documentation Costs	120
4.2.3.1.4	Engineering Design, Permitting, Contract and Bid Document Preparation, and Contract Administration Costs	120
4.2.3.1.5	Operations and Maintenance Costs	122
4.2.4	Full-Scale AquaBlok® Cap Installation Cost Analysis Summary	122
Section 5:	Technology Status.....	124
Section 6:	References.....	127

Appendices*

Appendix A	Vendor-supplied AquaBlok® Commercial Application Claims
Appendix B	AquaBlok® SITE Demonstration Oceanographic Survey Results
Appendix B-1	AquaBlok® SITE Demonstration One-month Post-capping Oceanographic Survey Results
Appendix B-2	AquaBlok® SITE Demonstration Six-month Post-capping Oceanographic Survey Results
Appendix B-3	AquaBlok® SITE Demonstration 18-month Post-capping Oceanographic Survey Results
Appendix B-4	AquaBlok® SITE Demonstration 30-month Post-capping Oceanographic Survey Results
Appendix C	AquaBlok® SITE Demonstration Sediment Profile Imagery Results
Appendix D	AquaBlok® SITE Demonstration Seepage Meter Testing Results
Appendix D-1	AquaBlok® SITE Demonstration One-month Post-capping Seepage Meter Testing Results
Appendix D-2	AquaBlok® SITE Demonstration Six-month Post-capping Seepage Meter Testing Results
Appendix D-3	AquaBlok® SITE Demonstration 18-month Post-capping Seepage Meter Testing Results
Appendix D-4	AquaBlok® SITE Demonstration 30-month Post-capping Seepage Meter Testing Results
Appendix E	AquaBlok® SITE Demonstration Sedflume Results
Appendix E-1	AquaBlok® SITE Demonstration Six-month Post-capping Sedflume Results
Appendix E-2	AquaBlok® SITE Demonstration 30-month Post-capping Sedflume Results
Appendix F	AquaBlok® SITE Demonstration Benthic Assay and Statistical Evaluation Results
Appendix G	AquaBlok® SITE Demonstration Sediment Coring Logs
	AquaBlok® SITE Demonstration Six-month Post-capping Sediment Coring Logs
	AquaBlok® SITE Demonstration 18-month Post-capping Sediment Coring Logs
	AquaBlok® SITE Demonstration 30-month Post-capping Sediment Coring Logs
Appendix H	AquaBlok® SITE Demonstration Sediment Coring Data and Graphs
	AquaBlok SITE Demonstration Sediment Coring Data
	Polycyclic Aromatic Hydrocarbon Data
	Polychlorinated Biphenyl Data
	Metals Data
	Physical Data
	AquaBlok SITE Demonstration Sediment Coring Graphs
	Polycyclic Aromatic Hydrocarbon Graphs
	Polychlorinated Biphenyl Graphs
	Metals Graphs
	Physical Graphs

Figures

Figure 1-1.	Integrated Conceptual and Actual View of AquaBlok® Capping Material	4
Figure 3-1.	Anacostia River Watershed (Anacostia Watershed Society Website)	20
Figure 3-2.	Locations of Preliminary AquaBlok® SITE Demonstration Study Areas	22
Figure 3-3.	Aerial Image of Preliminary AquaBlok® SITE Demonstration Study Areas	22
Figure 3-4.	AquaBlok® SITE Demonstration Area 1 Capping Cell Layout	23
Figure 3-5.	AquaBlok® in 2-Ton SuperSack at Staging Area	24
Figure 3-6.	Sand Cap Material Stored in Bulk at Staging Area.....	25
Figure 3-7.	Transferring Cap Material to Barge Using Conveyor	25
Figure 3-8.	Crane Barge Used to Place Caps in Demonstration Area	26
Figure 3-9.	Silt Curtains Deployed Around Demonstration Area Capping Cells	28
Figure 3-10.	Sedflume Schematic.....	33
Figure 3-11.	Principles of Acoustic Sub-Bottom Profiling.....	36
Figure 3-12.	Schematic of Sediment Profiling Camera	36
Figure 3-13.	Schematic of Typical Submerged Gas Flux Chamber	38
Figure 3-14.	Schematic of Ultrasonic Seepage Meter	40
Figure 3-15.	Conceptual Cross-Section of Ultrasonic Seepage Meter Flow Tube	40
Figure 3-16.	One-Month Post-Capping Field Event Sampling/Monitoring Locations	60
Figure 3-17.	Six-Month Post-Capping Field Event Sampling/Monitoring Locations	61
Figure 3-18.	18-Month Post-Capping Field Event Sampling/Monitoring Locations	62
Figure 3-19.	30-Month Post-Capping Field Event Sampling/Monitoring Locations	63
Figure 3-20.	Sedflume Coring Locations	65
Figure 3-21.	Potomac River (top) and Anacostia River (bottom) River Flows During Demonstration	67
Figure 3-22.	Sediment Coring Locations	68
Figure 3-23.	Total PAHs in Control Cell Cores	70
Figure 3-24.	Total PAHs in AquaBlok® Cell Cores	70
Figure 3-25.	Total PAHs in Sand Cell Cores.....	71
Figure 3-26.	Total PCBs in Control Cell Cores	71
Figure 3-27.	Total PCBs in AquaBlok® Cell Cores	72
Figure 3-28.	Total PCBs in Sand Cell Cores.....	72
Figure 3-29.	Total Metals in Control Cell Cores.....	73
Figure 3-30.	Total Metals in AquaBlok® Cell Cores	73
Figure 3-31.	Total Metals in Sand Cell Cores	74
Figure 3-32.	Survey Transects in Demonstration Area for Oceanographic Surveying	79
Figure 3-33.	One-Month Post-Capping Bathymetric Cap Thickness Map	81
Figure 3-34.	30-Month Post-Capping Bathymetric Cap Thickness Map	81

Figure 3-35.	One-Month Post-Capping Side-Scan Sonar Map.....	83
Figure 3-36.	30-Month Post-Capping Side-Scan Sonar Map.....	83
Figure 3-37.	Sediment Profile Imaging Monitoring Locations.....	84
Figure 3-38.	Video SPI Camera Penetration Trend.....	86
Figure 3-39.	Gas Flux Monitoring Locations.....	89
Figure 3-40.	Average TOC Concentration in Demonstration Area During SITE Demonstration.....	95
Figure 3-41.	Seepage Meter Monitoring Locations.....	98
Figure 3-42.	Specific Discharge Rates in AquaBlok® Cell During 30-Month Post-Capping Survey.....	101
Figure 3-43.	Specific Discharge Rates in Sand Cell During 30-Month Post-Capping Survey.....	102
Figure 3-44.	Specific Discharge Rates in Control Cell During 30-Month Post-Capping Survey.....	103
Figure 3-45.	Specific Discharge Rates in Demonstration Area During One-Month Post- Capping Survey.....	100
Figure 3-46.	Benthic Grab Sampling Locations (Including Baseline).....	109
Figure 3-47.	Abundance of <i>Dero nivea</i> in AquaBlok (AB), Sand (SO), and Control (UC) Cells.....	110
Figure 3-48.	Abundance of Chironomid Larvae in AquaBlok (AB), Sand (SO), and Control (UC) Cells.....	110
Figure 3-49.	Total Benthos Abundance in AquaBlok (AB), Sand (SO), and Control (UC) Cells.....	112
Figure 3-50.	Gas Void Occurrence Trend in Video SPI.....	112
Figure 4-1.	Typical Barge-Mounted Material Conveyor.....	118
Figure 4-2.	Typical Material Barge.....	118
Figure 4-3.	Conceptual Daily Work Cycle for “Typical” AquaBlok® Capping Project (10-acre AquaBlok® and Sand Cap).....	121

Tables

Table 2-1.	Summary of AquaBlok® Performance Expectations Relative to CERCLA Feasibility Criteria.....	18
Table 3-1.	Capping Cell Construction Design and Tolerances.....	24
Table 3-2.	Critical and Non-critical SITE Demonstration Measurements.....	31
Table 3-3.	SITE Demonstration Field Program Details.....	32
Table 3-4.	SITE Demonstration Gas Flux Sampling Observations.....	90
Table 3-5.	SITE Demonstration Gas Flux Sampling Results.....	91
Table 3-6.	Calculated Volumetric and Mass Gas Flux for Individual Compounds.....	93
Table 3-7.	SITE Demonstration Hydraulic Conductivity Results.....	97
Table 3-8.	SITE Demonstration Seepage Meter Results.....	104
Table 3-9.	Results of the Statistical Comparison of Specific Discharge between Cells.....	106
Table 4-1.	Cost Detail for “Typical” AquaBlok® Capping Project (10-acre AquaBlok® Cap with Sand Cover).....	119

Acronyms, Abbreviations, and Symbols

A	area
ADCP	acoustic Doppler current profiler
Ag	silver
AMS	Applied Marine Sciences, Inc.
ANOVA	analysis of variance
ARAR	Applicable or Relevant and Appropriate Requirement
ASTM	American Society for Testing and Materials
Athena	Athena Technologies, Inc.
AWTA	Anacostia Watershed Toxics Alliance
BMP	best management practice
bps	bits per second
°C	degrees Celsius
CAD	confined aquatic disposal (facility)
Cd	cadmium
CD	compact disc
CDF	confined disposal facility
CERCLA	Comprehensive Environmental Response, Compensation, and Liability Act
CH ₄	methane
cm	centimeter(s)
cm ²	square centimeter(s)
cm ³	cubic centimeter(s)
cm/s	centimeter(s) per second
cm ³ /s	cubic centimeter(s) per second
CNESS	chord-normalized expected species shared
CO ₂	carbon dioxide
COC	contaminant of concern
Cr	chromium
CSO	combined sewer outfall
Cu	copper
CV	coefficient of variation
CWA	Clean Water Act
cy	cubic yard
d	day(s)
<i>d</i>	Margalef's species richness
dGPS	differential global positioning system
DO	dissolved oxygen
<i>E</i>	erosion rate
ECC	Earth Conservation Corps

EPA	United States Environmental Protection Agency
E(S _n)	Sander's Rarefaction
FM	frequency modulation
F.O.B.	free on board (shipping)
FS	feasibility study
ft	foot/feet
ft ²	square foot/feet
ft/s	foot/feet per second
g	gram(s)
g/cm ³	gram(s) per cubic centimeter
gal	gallon(s)
gal/s	gallon(s) per second
GPS	global positioning system
GSA	General Services Administration
<i>H'</i>	Shannon Diversity Index
HASP	health and safety plan
HEC	habitat enhancement cap
Hg	mercury
HSD	Honestly Significant Difference
HSRC	Hazardous Substances Research Center
Hz	hertz
IC	institutional control
IDW	investigation-derived waste
in	inch(es)
ITER	Innovative Technology Evaluation Report
<i>J'</i>	Pielou's Evenness Index
K	hydraulic conductivity
kg	kilogram
kHz	kilohertz
L	liter(s)
lb(s)	pound(s)
lbs/ft ²	pounds per square foot
LSU	Louisiana State University
µg	microgram(s)
µg/g	microgram(s) per gram
µg/kg	microgram(s) per kilogram
µg/L	microgram(s) per liter
m	meter(s)
mm	millimeter(s)
m ²	square meter(s)
Matrix	Matrix Environmental and Geotechnical Services
mg	milligram(s)
mg/kg	milligram(s) per kilogram

MGP	manufactured gas plant
mi	mile(s)
mi ²	square mile(s)
MLLW	mean lower low water
MMT	monitoring and measurement technology
mol	mole(s)
N	Newton(s)
N ₂	nitrogen
N/m ²	Newton(s) per square meter
NAD	North American Datum
NAVD	North American Vertical Datum
Navy	United States Navy
ng	nanogram
nMDS	non-metric multi-dimensional scaling
NPL	National Priorities List
NRMRL	National Risk Management Research Laboratory
O ₂	oxygen
ORD	Office of Research and Development
osi	organism-sediment index
OSWER	Office of Solid Waste and Emergency Response
O&M	operation and maintenance
p/P	pressure
ρ	bulk density
PAH	polycyclic aromatic hydrocarbon
Pb	lead
PCB	polychlorinated biphenyl
ppb	parts per billion
ppbv	parts per billion by volume
ppm	parts per million
ppmv	parts per million by volume
ppt	parts per trillion
PSD	particle size distribution
q	specific discharge
Q	discharge
QA	quality assurance
QAPP	quality assurance project plan
QA/QC	quality assurance and quality control
QC	quality control
R	universal gas constant
RAO	remedial action objective
RCRA	Resource Conservation and Recovery Act
RD	remedial design
RI	remedial investigation
ROD	Record of Decision
RPD	Redox Potential Discontinuity

S'	Bray-Curtis similarity coefficient
SARA	Superfund Amendments and Reauthorization Act
sec	second(s)
SITE	Superfund Innovative Technology Evaluation
SPI	sediment profile imagery/imaging
SO	sand only
STP	standard temperature and pressure
t	time
T	time or temperature
τ	shear stress
TER	Technology Evaluation Report
TNMOC	total non-methane organic carbon
TOC	total organic carbon
UC	uncapped control
USCG	United States Coast Guard
USDA	United States Department of Agriculture
USGS	United States Geologic Survey
UT	University of Texas
UXO	unexploded ordnance
v	velocity
V	velocity or volume
WASA	Washington Area Water and Sewer Authority
WINOPS	Windows-based Offshore Positioning Software
Zn	zinc
ZVI	zero-valent iron

Acknowledgements

This report was prepared by Battelle Memorial Institute (Battelle) of Columbus, Ohio, under the direction of Dr. Edwin Barth, the U.S. Environmental Protection Agency's (EPA) Superfund Innovative Technology Evaluation (SITE) task order manager at the National Risk Management Research Laboratory (NRMRL) in Cincinnati, Ohio. Under the direction of Dr. Barth and other EPA technical staff, Battelle was tasked with designing, conducting, and evaluating the demonstration of the AquaBlok[®] sediment capping technology. Contributors and/or reviewers for this report were Mr. John Hull of AquaBlok, Ltd. in Toledo, Ohio, Dr. Joe Jersak of Biologge AS in Sandefjord, Norway, and Dr. Danny Reible of the Hazardous Substances Research Center (HSRC) at Louisiana State University (LSU) in Baton Rouge, Louisiana and the University of Texas (UT) in College Station, Texas. In addition, technical review comments were provided by Bob Lien, Barbara Bergen, and Terry Lyons of EPA's Office of Research and Development (ORD), Eric Stern of EPA Region II, and Dr. Carl Herbranson of the Minnesota Department of Health. Staff at the Earth Conservation Corps (ECC), Washington Area Water and Sewer Authority (WASA), and the General Services Administration (GSA) in Washington, DC was extremely generous in facilitating field operations. In particular, Ms. Brenda Richardson and Mr. Glen Ogilvie of ECC, Mr. Charles Wynn and Mr. Carl Banks of WASA, and Mr. Robert Oliphant of GSA were invaluable in coordinating and successfully implementing field operations. Facilities operations personnel at the Washington Navy Yard were generous in allowing the collection of tidal data along their secure bulkhead, and the Harbor Police in Washington, DC and security personnel at WASA were highly professional throughout the field demonstration project.

Section 1 Introduction

Under the U.S. Environmental Protection Agency (EPA) Superfund Innovative Technology Evaluation (SITE) Program, the effectiveness of AquaBlok[®], a proprietary clay polymer composite developed by AquaBlok, Ltd. of Toledo, OH that represents an alternative to traditional sediment capping materials such as sand, was evaluated in the Anacostia River in Washington, DC as an innovative contaminated sediment capping technology.

This introduction briefly describes the EPA's SITE program and the reports produced to document a SITE demonstration project. This introduction also provides the purpose and general organization of this Innovative Technology Evaluation Report (ITER). Background information on the development of the AquaBlok[®] sediment capping technology is also provided, including a general description of the technology and its claimed or documented innovative characteristics, as well as a list of key contacts who can supply additional information and details about the technology and the demonstration site.

1.1 Description of the SITE Program and SITE Reports

This section briefly describes the purpose and goals of the SITE program and the reports produced to document the results of SITE demonstration projects.

1.1.1 Purpose and Goals of the SITE Program

The primary purpose of the SITE program is to advance the development and demonstration of innovative environmental remediation technologies that are likely applicable to Comprehensive Environmental Response, Compensation, and Liability Act (CERCLA; i.e.,

Superfund) and other hazardous waste sites, and to thereby facilitate the commercial availability and applicability of such technologies. The SITE program is administered by the EPA's Office of Research and Development (ORD) National Risk Management Research Laboratory (NRMRL) in the Land Remediation and Pollution Control Division.

The overall goal of the SITE program is to carry out the research, evaluation, testing, development, and demonstration of alternative or innovative environmental remediation and treatment technologies that may be used in response actions at cleanup sites to achieve long-term protection of human health and the environment.

Data collected during demonstration projects are used to assess the performance of technologies against pre-determined measurement endpoints to determine applicability and likelihood for successful implementation at cleanup sites. The data are used to determine key technology parameters such as the potential need for pre- or post-treatment, the types of contaminants, wastes, and media that could be successfully addressed, operational design considerations and limitations, and typically associated capital and operating costs. Demonstration data can also provide information on long-term operation and maintenance (O&M) or monitoring needs as well as long-term application risks.

Under each SITE demonstration project, a particular technology's performance is assessed by how it addresses a particular waste type or contaminant suite at a particular site. While successful demonstration of a technology's performance at the demonstration site is important in interpreting the applicability and functionality of the technology, it does not

necessarily ensure the technology's success at other sites. Data obtained during a SITE demonstration project can and often do require extrapolation to estimate an appropriate range of operating conditions over which the technology would function effectively and successfully. In addition, other available case study information on a particular technology should be used to extrapolate technology performance conclusions.

SITE demonstration projects typically rely on cooperative arrangements between EPA, the technology developer, and the site owner/operator. EPA is generally responsible for project planning, monitoring, sampling and analysis, quality assurance and quality control (QA/QC), report preparation, and project information publication and dissemination. The site owner/operator is generally responsible for routine site logistics and transport and disposal of investigation-derived waste (IDW). The technology developer is typically responsible for providing the technology to be demonstrated and for mobilizing and demobilizing equipment required to deploy the technology.

1.1.2 Documentation of SITE Program Results

The results of SITE demonstration projects are documented in four individual reports: a Technology Demonstration Bulletin; a Technology Capsule; a Technology Evaluation Report (TER); and an ITER. The Technology Demonstration Bulletin provides a brief description of the technology and SITE project history, notification that the SITE demonstration was completed, and key highlights of the demonstration project findings. The Technology Capsule provides an even more brief description of the SITE project and an overview of the project findings and conclusions.

The purpose of the TER is to consolidate the information and data generated during the SITE project, and summarizes the data generated during the SITE project in comparison with QA/QC protocols and data quality objectives (DQOs) relative to measures of data usability, including accuracy, precision, and completeness. The TER is not formally published by EPA, but is

retained by EPA as a reference for responding to public inquiries and for record-keeping purposes.

The Technology Demonstration Bulletin, Technology Capsule, and TER are produced as separate, stand-alone documents generally in parallel with the ITER. The Bulletin, Capsule, and TER will be produced in this fashion for the AquaBlok® SITE demonstration documented herein. The ITER is discussed in more detail in Section 1.1.2.1.

1.1.2.1 Purpose and Organization of the ITER. The purpose of the ITER is to assist decision-makers in evaluating specific environmental remediation and treatment technologies for applicability to various cleanup scenarios and specific cleanup sites. The ITER discusses the effectiveness and applicability of a technology and provides an assessment of the costs associated with the deployment of the technology. The technology is evaluated on the basis of data collected during the SITE demonstration project and, if and where available, from other case studies. The applicability of the technology is discussed in terms of contamination and site characteristics that could affect technology performance, handling requirements, limitations, and other important factors. The ITER represents an important step in the full-scale development and commercialization of an environmental remediation technology demonstrated through the SITE program.

This ITER has been prepared specifically to summarize the SITE demonstration of the AquaBlok® sediment capping technology in the Anacostia River in Washington, DC. Consistent with the general layout of most ITERs, this ITER consists of the following sections:

- Section 1 – Introduction: briefly describes the SITE program in general terms and the reports produced to document a SITE demonstration project. Specifically summarizes the purpose and layout of this ITER and briefly summarizes the AquaBlok® technology.
- Section 2 – Technology Applications Analysis: discusses information relevant to the application of AquaBlok®, including an

assessment of the technology in the context of the nine CERCLA feasibility criteria and the operational and technical limitations of the technology.

- Section 3 – Technology Effectiveness: presents information related to the design and implementation of the AquaBlok® SITE demonstration at the demonstration site. This section also summarizes the objectives of the project, the procedures used in carrying out the demonstration, and the findings of the demonstration.
- Section 4 – Economic Analysis: summarizes the actual costs (within several principal cost categories) associated with deploying AquaBlok®, and discusses variables and scaling factors that may affect the technology's cost at other sites.
- Section 5 – Demonstration Conclusions: summarizes the conclusions of the AquaBlok® SITE demonstration and the status of the development and commercial availability of the technology evaluated.
- Section 6 – References: lists the references used in compiling the ITER.

1.2 AquaBlok® General Technology Description

AquaBlok® is a proprietary clay polymer composite developed by AquaBlok, Ltd. of Toledo, Ohio. AquaBlok® material is designed to contain and isolate contamination in subaqueous sediments in predominantly non-terrestrial settings. In addition, the material can be used for other applications, such as in retention pond or wastewater basin lining, well sealing, and erosion control.

AquaBlok® is a particulate material, with each particle comprised of an aggregate core covered by a clay and polymer coating. The clay in most applications is primarily bentonite, and the polymer is added to promote adhesion between the clay and the aggregate core. Specific

formulations that incorporate other clay types (e.g., attapulgite) or additives (e.g., plant seeds) are available or can be designed to address site-specific (e.g., salinity) or action-specific (e.g., treatment requirements) needs. The material is generally applied as a dry product through the water column to the surface of contaminated subaqueous sediments and hydrates to form a continuous and impermeable isolation cap. An integrated conceptual and actual depiction of AquaBlok® as a contaminant barrier is provided in Figure 1-1.

AquaBlok® claims to offer distinct advantages over materials traditionally used to cap contaminated sediments (i.e., sand or clean native sediment). These advantages, as generally claimed, include:

- Low aqueous permeability and transmissivity due to low hydraulic conductivity (on the order of 10^{-9} centimeters per second [cm/s] for typical bentonite freshwater formulations);
- High degree of cohesiveness and cap uniformity due to coalescing of individual particles on hydration;
- High contaminant attenuation capacity due to binding capacity of the clays used;
- Contaminant non-specificity due to very low permeability and uniform isolation coverage;
- High resistance to physical erosion due to cohesiveness;
- Lower thickness requirements for contaminant isolation due to physical properties of material; and
- Compatibility with other remediation elements and amendments (e.g., reactive components or seed).

AquaBlok® can be manufactured in specific blends to accommodate specific cleanup objectives. It is generally packaged in large bags

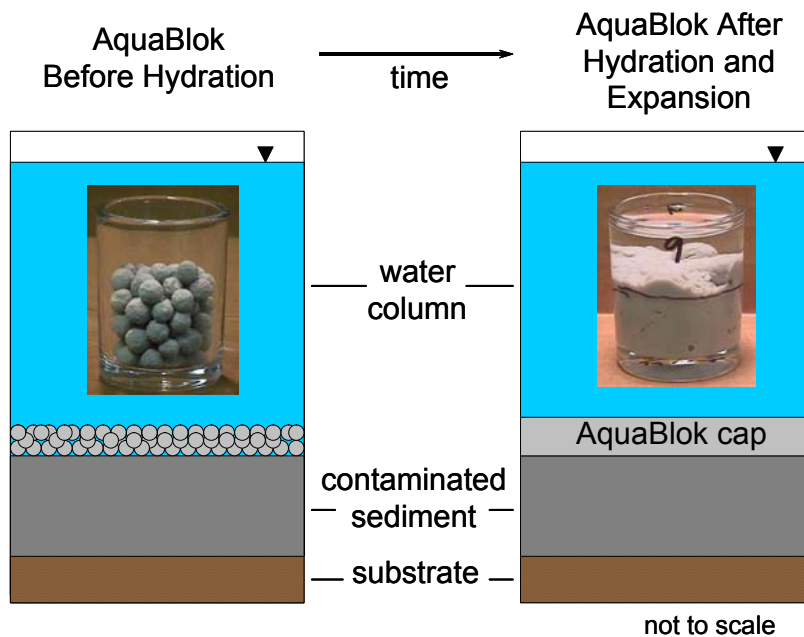

Figure 1-1. Integrated Conceptual and Actual View of AquaBlok® Capping Material
(EPA Tech Trends, February 2000)

but can be packaged loose in bulk containers. It can be transported by truck, rail, or barge, and can be directly deployed at cleanup sites from land using typical excavation equipment, from water using direct-application barges or barge cranes, or by air using helicopters. It can also be placed by hand if necessary. The material can be manufactured on site to meet a specific need or to achieve cost advantage (i.e., by using local sources of component materials). AquaBlok® can be placed, as with more traditional sediment capping materials, in one or more lifts to achieve a design cap thickness, and can be armored with other materials (e.g., sand, gravel, or stone) if necessary.

The first application of AquaBlok® as an environmental remediation technology occurred in an impacted wetlands at a Superfund (i.e., CERCLA) site in Alaska known as Eagle River Flats. The AquaBlok® material was developed for the Eagle River Flats site in a collaborative effort between commercial interests and the United States Department of Agriculture (USDA). AquaBlok® was subsequently included in the Record of Decision (ROD) for the site for the in situ management of impacted sediments. Since that time, AquaBlok® has, based on information provided by AquaBlok, Ltd., been successfully

deployed as a sediment remediation technology at 10 sediment remediation project sites and evaluated at bench-scale at several others.

1.3 Key Contacts

Additional information on the AquaBlok® sediment capping technology or the AquaBlok® SITE demonstration project is available from the following contacts:

Edwin Barth, Ph.D., P.E., C.I.H.
U.S. Environmental Protection Agency
Office of Research and Development
26 West Martin Luther King Drive
Cincinnati, OH 45268
Telephone: (513) 569-7669
Fax: (513) 569-7158
barth.ed@epa.gov

Andrew Bullard, M.E.M.
Principal Research Scientist
Environmental Restoration
Battelle Memorial Institute
125 Pheasant Run, Suite 115
Newtown, PA 18940
Telephone: (215) 504-5312
Fax: (614) 458-6622
bullarda@battelle.org

John Hull, P.E.
AquaBlok, Ltd.
3401 Glendale Avenue
Suite 300
Toledo, OH 43614
Telephone: (800) 688-2649
Fax: (419) 385-2990
jhull@aquablokinfo.com

Danny Reible, Ph.D.
Department of Civil, Architectural and
Environmental Engineering
The University of Texas at Austin
1 University Station C1786
Austin, Texas 78712-0283
Telephone: (512) 471-4642
Fax: (512) 471-5870
reible@mail.utexas.edu

Section 2

Technology Applications Analysis

This section describes the general applicability and anticipated effectiveness of the AquaBlok[®] sediment capping technology at hazardous waste cleanup sites. It also describes factors at any given site that might affect the performance of the AquaBlok[®] technology, and summarizes the expected performance of this technology in the context of the nine CERCLA criteria used during feasibility studies to assess the reasonableness of a potential remediation strategy to accomplish environmental cleanup at a site.

Additional vendor-supplied information regarding specific applications, formulations, and commercial status of the technology is provided in Appendix A. The information provided in Appendix A is based exclusively on vendor-supplied information, and has not been independently verified.

2.1 Key Technology Features

For contaminated subaqueous sediments, the most common remediation strategies are dredging, which involves the removal of contaminated material (and potentially the placement of fill material to restore the sediment surface to its original elevation or to cover residual contamination exposed by dredging but economically infeasible to remove), and capping, which involves the placement of a barrier between the contaminated sediment and the overlying water. Capping, subsequently, can be accomplished using isolation caps, which function by completely isolating sediment contaminants from the overlying water, or thin-layer or habitat enhancement caps (HECs), which function by creating a clean layer of adequate but minimal thickness to provide an appropriate level of isolation while allowing natural physical and ecological mechanisms to function as a component of the remedy (e.g., natural recovery).

Generally, capping approaches are less costly than dredging, but do typically require longer-term O&M activities to ensure remedy integrity and the achievement of remedial action objectives (RAOs).

Capping contaminated subaqueous sediments can be accomplished using common earth materials such as sand and gravel, or using clean sediment similar to that being capped (generally proportionally finer grained material such as silts and clays for most contaminated sediment sites). If necessary, sediment caps can be armored against physical stresses using an armoring layer such as gravel or stone.

AquaBlok[®] is a proprietary clay polymer composite designed to hydrate and form a continuous and highly impermeable isolation layer over contaminated sediments. While it is claimed there is no practicable limit to the depth at which the material would function, AquaBlok[®] is typically produced for application in relatively shallow, freshwater to brackish, generally nearshore environments and is comprised of bentonite clay with polymer additives covering a small aggregate core. The bentonite clay is comprised principally of montmorillonite, and the proprietary polymer is added to further promote the adhesion and coalescing of clay particles to the aggregate core. The aggregate core is used essentially for weighting to promote the sinking of the AquaBlok[®] material to the sediment surface. AquaBlok[®] functions by hydrating, swelling, and forming a continuous and highly impermeable isolation layer above contaminated sediments. Based on information provided by the vendor, AquaBlok[®] formulations experience a significant swelling upon placement and hydration, and freshwater formulations are characterized by intrinsic permeabilities on the order of 10^{-9} cm/s.

Sediment caps, which have been employed in the field at hazardous waste cleanup sites, are an in situ remediation technology for contaminated sediment management. Sediment caps have the general advantage of being low-cost and they do not generate secondary waste streams requiring disposition at a landfill or a constructed waste containment facility (e.g., a confined aquatic disposal [CAD] facility or confined disposal facility [CDF]), as with sediment dredging.

2.2 Applicable Wastes

AquaBlok[®] capping material is designed to function by swelling and forming a continuous and highly impermeable isolation barrier between contaminated sediments and the overlying water column. As such, it is considered a non-specific capping material that would function by encapsulating any class or type of contaminant as well as theoretically any range of contaminant concentration.

AquaBlok[®] formulations can be modified to include clays that are specifically more appropriate for a particular environmental setting. For instance, in a more saline environment, attapulgite clay could be used instead of bentonite (i.e., montmorillonite), and in other situations, organoclays could be used in the formulation. Formulations of AquaBlok[®] can also be made to incorporate specific amendments designed to react with certain contaminants. For instance, activated carbon or zero-valent iron (ZVI) amendments could be integrated into the material to provide a reactive contribution to address chlorinated organic (and potentially other) contaminants. In addition, vendor supplied information suggests AquaBlok[®] could be designed using a “funnel and gate” approach, where reactive pathways would be deliberately integrated into an AquaBlok[®] cap to control contaminant movement and treat contamination moving through aqueous and/or vapor flux mechanisms. However, the type of AquaBlok[®] discussed in this ITER is a characteristically “basic” formulation of bentonite, polymer, and aggregate, the purpose of which is to provide an effective isolation barrier for contaminated sediment.

2.3 Technology Operability, Availability, and Transportability

As discussed above, AquaBlok[®] is generally considered a non-specific capping material designed to provide a continuous and impermeable barrier between contaminated sediment and overlying surface water regardless of contaminant nature or magnitude. However, in some cases, it may be desirable to formulate an AquaBlok[®] capping material to incorporate a reactive component to specifically address some contaminant, and other formulations may be needed or desired on the basis of local geochemical characteristics (e.g., salinity).

The overall operability of the technology is not as strongly influenced by site-specific factors as a terrestrial remediation approach would be given its broadcast applicability to various waste types. However, several factors could affect the operability of AquaBlok[®] at a contaminated sediment site and influence decision-making related to specific material formulation. These factors include, but are not necessarily limited to:

- Hydrology (including depth of surface water, groundwater discharge and recharge characteristics, and/or local flow velocities and shear stresses);
- Physical and geochemical properties of the surface water (including salinity, sediment depositional characteristics, and/or tidal characteristics);
- Physical, geotechnical, and ecological properties of the contaminated sediment site (including presence and distribution of intertidal sediments and subtidal sediments, sediment compressive strength, and/or gas ebullition potential);
- Ecological properties of the contaminated sediment site (including presence and distribution of emergent or submergent plants, fish, and/or benthos);
- Nature, distribution and magnitude of contamination (as it relates to decisions regarding the applicability or desirability of

reactive amendments and required lateral extent and/or thickness of capping material);

- Climatic conditions (as they relate to variability in surface water or sediment characteristics, such as tidal variability and/or temperature effects on gas ebullition);
- Site characteristics and land use features (including recreational uses, access concerns or limitations, ongoing contaminant sources, site reuse/redevelopment, and/or the need for institutional or engineering controls);
- Remediation goals (including contamination-related risk reduction and habitat enhancement); and
- Short- and long-term monitoring requirements (including sampling and analysis).

AquaBlok® is a commercially available technology that has been successfully deployed during environmental remediation projects. In its component form, the aggregate and clay materials used in AquaBlok® formulations are readily available from common sources of earth materials. For instance, bentonite is a readily available material used in the well drilling industry. The polymers used are proprietary and developed directly by AquaBlok, Ltd.

The equipment needed to support the application of AquaBlok® as a sediment capping remedy is generally standard and not site specific. Such equipment is, by and large, limited to equipment required to convey the AquaBlok® material to a site, move it around the site for staging purposes, and place on the surface of the contaminated sediment. Terrestrial earth moving equipment (e.g., excavators or cranes) or water-based moving equipment (e.g., barges with or without cranes or excavator extensions) are both commonly used to place AquaBlok®. In some cases, AquaBlok® may be placed manually. In other unique cases, due to the inability of using other standard earth moving equipment or remoteness of a site, tools such as a helicopter may be required to place AquaBlok®. Equipment required to monitor the performance and function of AquaBlok® after placement (e.g., aquatic geophysical surveying tools) is generally specialized for the contaminated sediment

management arena, but is also generally standard and readily available from a number of vendors who specialize in this area.

AquaBlok® material and the equipment used to deploy and monitor it can reasonably be considered easily transportable. AquaBlok® is generally packaged in large bags (e.g., 1 to 20 ton capacity) and transported to a site via truck or rail, where it is managed and placed using terrestrial and/or water-based earth moving equipment. Alternatively, barges may be loaded with bulk AquaBlok® material and the material transported in this manner to a capping site. In other cases, AquaBlok® could be formulated at a cleanup site based on the proximity to sources of earth materials or ease of access to modes of transportation to move the earth materials required to make the necessary formulation. Terrestrial earth moving equipment is easily transportable to a site by standard over-the-road hauling, and aquatic earth moving equipment can generally be navigated to a site along existing waterways or mobilized using over-the-road hauling much like terrestrial equipment. Monitoring tools needed for an AquaBlok® remedy are similarly easily transported via land or waterways.

Capping contaminated sediment with AquaBlok® is considered a single-use technology application. AquaBlok® deployed at one cleanup site would not be removed and redeployed at another site, as might be done with a treatment system for contaminated groundwater. In this sense, AquaBlok® is not a “transportable” technology. However, in the context of a single-use technology, all materials and equipment used to implement an AquaBlok® sediment capping remedy are readily and easily transportable.

2.4 Range of Suitable Site Characteristics

In general, any site with contaminated subaqueous sediment would be compatible with the deployment of an AquaBlok® sediment cap. However, the practicability and consequent cost-effectiveness of incorporating AquaBlok® into a sediment remedy will vary based on the project location, size of the project, accessibility for

application, and remediation and restoration objectives. Similarly, the implementability of an AquaBlok® capping remedy could be constrained by legal and/or regulatory restrictions or allowances applicable on a site-specific basis.

AquaBlok® is a technology that reportedly can provide a wide variety of management functions, including permeability control, chemical sequestration, physical stabilization, and facilitation of in situ treatment. Thus, the specific product formulation, application rate, presence/absence of special additives or incorporation of other materials as part of an AquaBlok®-based composite cap design (e.g., geotextiles, sand, or armoring stone) would be highly dependent upon site-specific conditions and specific remediation goals.

An AquaBlok®-based cap can be designed for many applications to meet multiple remediation goals and can be used alone or in combination with other materials based on restoration goals, accessibility for application, long-term monitoring goals, availability, regulatory requirements, and relative cost of other materials such as sand or armoring stone. In addition, the flexibility of cap design must be considered in situations where excessive cap thickness could negatively impact available floodway cross-sections.

AquaBlok® claims to be effective and advantageous in capping sediments in deeper-water and higher-energy regimes, and an AquaBlok®-based capping solution can address a range of contaminated sediments including metals and organic compounds. In addition, AquaBlok® used in conjunction with “hotspot” removal activities (e.g., to cap post-dredging residual contamination) could potentially help improve project efficiency by supporting the acceptability of prescriptive removal of a specific volume with the subsequent addition of an isolation cap. This remedial strategy could potentially not only significantly reduce uncertainties but minimize project costs by reducing the need for significant sampling and subsequent re-dredging (both of which are often required for environmental dredging programs that typically target specific and conservative post-dredging levels of residual contamination).

Formulations of AquaBlok® are available or can be developed to cover a wide range of salinities, meaning that riverine, lacustrine, deltaic, estuarine, wetland, offshore, and tidally mixed nearshore environments are all candidate sites. In addition, AquaBlok® claims to be highly resistant to erosion and could therefore be deployed in environments with variable hydrologic energy regimes. Furthermore, AquaBlok® is a non-specific capping material, and the use of this material is largely not constrained by the nature or magnitude of the sediment contaminant load.

Overall, the range of suitable site characteristics allowing the consideration of an AquaBlok® sediment cap is based on physicochemical site setting and is very broad. However, limitations to the use of AquaBlok® do exist and are discussed in Section 2.7.

2.5 Site Support Requirements

In general, there are no site support requirements to effectively deploy an AquaBlok® cap. All materials and equipment, both to place and monitor the cap, typically originate from off-site sources and do not require specific site support. In some cases, if AquaBlok® is deployed to the subaqueous environment from land, a controlled area may be needed to place and operate equipment and to stage materials during placement, and controls may be required to prevent access to such work areas. However, following construction, there would likely be no permanent features other than the in-place cap, and no long-term site support requirements would therefore exist.

For capping from water using water-based equipment, there are typically no site support requirements of any kind, other than the potential need to transport and deploy water-based equipment from the landside portion of the site. In this case, the same staging and site control considerations may be valid.

It may be necessary to control access to or use of the water body in the area where an AquaBlok® cap has been placed. The use of a water body in

the area of a sediment cap is often restricted through the implementation and enforcement of administrative control mechanisms and engineering controls. This could be accomplished, for instance, by using markings (such as buoys) or posting signs indicating the presence of a subaqueous remedy and restricting site use in any way that could impact the function of the cap (e.g., recreational uses/ anchoring restrictions).

Monitoring an AquaBlok® cap following placement would generally be conducted on a periodic basis using equipment and personnel imported for each monitoring event. As such, there would generally not be permanent monitoring devices left in place at the site and no site support requirements to ensure the permanence and function of such equipment.

2.6 Material Handling and Quality Control Requirements

The placement of an AquaBlok® cap would preclude the requirement to handle contaminated wastes, as the technology is deployed as an alternative to removing contaminated sediment. As such, the contaminated material handling requirements that might otherwise govern the dredging, transportation, and disposal of impacted sediment from a site would not be pertinent.

AquaBlok® itself is a generally inert material consisting of aggregate, clay, and polymer additives. However, to the extent that specific handling requirements would be relevant to the components in AquaBlok®, these handling requirements should be followed when placing the material at a contaminated sediment site. All generally acceptable practices for working with and around heavy earth moving equipment required to place an AquaBlok® cap should also be adhered to. A detailed Health and Safety Plan (HASP) should be in place to define the necessary material handling and hazard mitigation techniques to be followed when deploying an AquaBlok® sediment capping remedy.

When placing any cap, the strength of the sediments being capped must be considered. Often, contaminated sediments are fine-grained, soft, and highly organic, and are not able to sustain significant vertical loads without significant mixing of cap material and native sediment, resuspension of contaminated sediment to the water column, or mass lateral movement of native sediment (i.e., in a manner commonly known as mud-waving). Therefore, it would be important to approach an AquaBlok® capping remedy with a clear focus on preventing unwanted residuals mobilization or contaminated sediment movement, and material handling requirements may dictate slow, low energy placement of the AquaBlok® instead of rapid, broadcast application of the material through the water column. Slow, low energy placement could be accomplished using a crane or excavator to place individual buckets of AquaBlok® under the water surface and near the sediment surface. However, in certain situations, the broadcast placement of AquaBlok® with a split-bottom barge or other means might be acceptable. In other cases, it may be appropriate to slowly and carefully place a single lift of AquaBlok® and establish a solid and stable foundation on which subsequent lifts could be placed less deliberately by broadcast application. Such considerations would be very important during the capping design stage.

2.7 Technology Limitations

The most significant limitation to the application of AquaBlok® as a viable sediment remediation technology is its ability to remain hydrated. Because the technology's function is predicated on proper and sustained hydration of the clay polymer material, there are certain environments that would characteristically not support this technology (e.g., sediments above the inundated zone). According to the material vendor, the capillarity of the material can promote hydration upslope of the inundated environment (i.e., creating a continuously hydrated cap with the toe of the cap submerged), and it is conceivable that the clay material could remain hydrated enough to remain functional during an unanticipated dewatering event (e.g., an unanticipated drought that temporarily lowered water levels). In

addition, given its plasticity and based on vendor claims, the material has shown an ability to heal after desiccation and/or freeze/thaw cycles. Nevertheless, a proper design level consideration would be that the environment of interest continuously supports hydration of the AquaBlok® material.

As with any capping technology, reducing the effective cross-section of a water body could have a significant bearing on its applicability and desirability, particularly if the water body is used for navigation, ship berthing, or recreation. Similarly, sediment caps would only be effective if the specific geomorphology of the site was amenable to placing a cap. For instance, in a riverine or coastal environment with very steep slopes, a sediment cap would potentially be subject to mass movement and could potentially not be adequately relied on to remain in place.

Another limitation to the effectiveness of any cap is the presence of and/or incursion of debris. For instance, to properly deploy a sediment cap, it would likely be required that substantial debris (e.g., tree limbs, large boulders or concrete rubble) that could represent a potential for cap failure be removed from the contaminated sediment surface. This would add mobilization, operational, and disposal costs and require an additional incremental amount of time to fully implement any capping remedy. Similarly, in environments where significant debris incursion is anticipated, it could be necessary to provide for some engineering mechanism to prevent the potential for debris to influence the effectiveness of the cap.

Of related concern is the presence of ice in a water body and the potential for ice-driven scour on the cap through ice shoves or ice flow, or even ice-related damage through simple freeze-thaw cycles leading to ice lenses, blistering, or frost penetration (see, for instance, published information on sediment remediation projects in the Fox River [EPA, 2006], the Grasse River [Alcoa, 2007], and Ottawa River [Hull & Associates, Inc., 2002]). As such, while an AquaBlok® cap, or any sediment cap for that matter, may be a suitable remedial strategy for a site in a temperate climate or hydrodynamic

regime without significant threat of ice or prolonged freezing, it may not be appropriate where significant ice impacts could occur (unless specific engineering protections could be constructed to mitigate this performance risk). The demonstration summarized in this ITER did not attempt to evaluate ice impacts in any way.

Gas ebullition from contaminated sediment could represent a limiting characteristic of an environment as it relates to the selection of AquaBlok® as an appropriate remedy. Gas buildup in contaminated sediment capped with a highly impermeable material could lead to failure of the capping material as the pressure of the accumulating gasses seeks a route of escape. A similar concern would likely not be associated with a traditional sand capping material, the permeability of which would typically allow gases evolved from underlying sediments to dissipate without likely compromising cap integrity.

The required monitoring approach for a sediment remediation site could be an impediment to using a capping technology. If there are inflexible post-capping monitoring requirements that call for significant and repetitive coring, for instance, the very act of monitoring the integrity of the cap could substantially decrease its effectiveness (i.e., by removing a sufficient amount of cap material to create essentially uncapped areas or preferential contaminant migration pathways). However, given its cohesiveness and tendency to form a uniform and continuous low-permeability layer, AquaBlok® is claimed to be capable of self-repairing after being altered through physical sampling (or gas release), and capping remedies typically include a requirement for localized cap repair if and as needed to provide continued remedy effectiveness.

Common earth materials such as clays used in environmental remediation applications can contain traces of the same contaminants creating the hazardous condition at a cleanup site. For instance, common clays often contain heavy metals in some concentration given the ubiquitous geologic presence of metals and the high affinity clays have for metals through cation exchange. However, it is likely that the hazardous condition at a cleanup site would be

significantly greater in terms of concentration compared to naturally-occurring metal loads in a clay material applied at a site. In a related sense, given the high affinity that clays have for metals and potentially other ionic contaminants, it is conceivable that an AquaBlok® cap could act as a sink of such contamination from an underlying contaminated sediment. In other words, it is conceivable that contaminants could be “wicked” into an AquaBlok® cap. However, once the exchange capacity of clay is saturated, it is unlikely such a phenomenon would exist, and it is also unlikely that such sorbed contaminants would represent a bioavailable source of risk given the high binding capacity between clays and metals (and other contaminants).

Given that AquaBlok® is a containment technology, it could be inappropriate for sites where there is a regulatory prerequisite for treatment to reduce volume, toxicity, or mobility. However, some formulations of AquaBlok® either already developed or under development could integrate the common mixture of clay, polymer, and aggregate with a treatment component such as activated carbon or ZVI.

Finally, given that AquaBlok® is a highly impermeable clay material, it could be inappropriate for sites where there is an abundant ecological community that relies on a coarser grained sediment habitat or where there could be an anticipated detrimental impact on habitat and ecology associated with placing a substantially thick layer of ecologically “inert” material. Similarly, in an environment where vegetation is common, the growth or regrowth of rooted plants could detrimentally affect any cap’s performance by creating root paths or by promoting root uptake of contaminants.

2.8 Factors Affecting Performance

There are factors that could influence the performance of an AquaBlok® cap at a contaminated sediment site. By and large, the factors that could influence the performance of an AquaBlok® cap are the same issues identified in Section 2.7 as being potential technology limitations.

In an environment where water levels fluctuate or contamination extends beyond the inundated zone, the performance of AquaBlok® could be affected by permanent or periodic lack of complete hydration. In an environment with significant debris incursion or the buildup of ice, large debris items or ice flows/dams could scour AquaBlok® material from the cap or become lodged in the cap, thereby completely removing the cap or creating channels through the impermeable material (as noted in Section 2.7, the demonstration summarized in this ITER did not attempt to evaluate ice impacts in any way). Where gas ebullition is a significant and/or frequent occurrence, gas pressure buildups could lead to cap failure, lessening the effectiveness of the cap for some duration (i.e., until the cap is able to self-repair or repairs can be made through O&M design).

During monitoring activities, invasive sampling (e.g., coring) could create isolated cap failure regions by removing AquaBlok® material and creating a channel for contaminant short-circuiting. Similarly, if a water body in which an AquaBlok® cap is deployed is used for recreational purposes or is navigated by watercraft, it is possible that anthropogenic activity could undermine the effectiveness of the cap. Specifically, anchor scour or propeller wash could be responsible for removing AquaBlok® material, limiting its effectiveness relative to remediation design criteria.

Another critical performance-limiting factor common to all caps is the potential for contaminated sediment to be deposited on top of the cap either as a result of resuspension during cap placement and/or the deposition of new sediment contaminated by ongoing sources.

Lastly, an AquaBlok® cap could be limited in its overall effectiveness if remediation performance requirements include accomplishing contaminant treatment (unless used in conjunction with other treatment options) and/or not altering an ecological equilibrium.

The means of mitigating these potential performance-affecting factors are generally fivefold. The first is to properly and reasonably

select a site in the context of RAOs before deploying an AquaBlok® cap. For instance, it could be appropriate to consider AquaBlok® for a contaminated sediment site where the introduction of a clay-based cap would not significantly alter ecological health as it relates to substrate if this were a key RAO. The second is to properly design the capping remedy, including an appropriate means of deploying the AquaBlok® cap to limit the resuspension of contaminated sediment that could subsequently recontaminate the clean cap surface and consideration of adequate armoring against anticipated cap damage. The third is to develop and implement an adequate monitoring plan, potentially incorporating a restoration contingency to repair any damage to the AquaBlok® cap, to ensure its continued effectiveness. The fourth is to ensure that potential ongoing sources have been controlled and/or eliminated. The fifth is to execute and maintain any and all institutional controls (ICs) that would serve to limit or prevent activities that could directly impact the integrity and effectiveness of the cap. As suggested by this information, these are common and generally simple means to mitigate against the potential for reduced effectiveness, and are typically considerations of any remedial action.

2.9 Site Reuse

Overall, it is likely that an AquaBlok® cap could be designed to properly and successfully integrate into a full spectrum of site reuse scenarios for a contaminated sediment site. For instance, an AquaBlok® cap could be designed to provide appropriate levels of risk management even within the context of a subsequent construction plan calling for a marina, pier, or some other structure.

However, as suggested in the previous section, it is unlikely that a completely unrestricted site reuse would be acceptable at a contaminated sediment site where AquaBlok® is deployed, as contaminated sediment would be left in place and a long-term monitoring and maintenance program would be required to ensure remedy integrity and function. Accordingly, it is likely that some form of site use restrictions would be in place in the form of ICs. For instance, recreational use

restrictions could be executed to restrict the size of vessels that could pass over the cap or the speed of these vessels to eliminate the potential for propeller scour. Moreover, it is possible that physical access restrictions (e.g., buoys indicating an exclusion area) could be deployed.

It is also quite likely that site uses that could lead to the capture and/or consumption of potentially contaminated food items would be limited or prohibited. For instance, it is common at contaminated sediment sites for fishing advisories to be in place for the duration of a capping remedy to restrict or prohibit the catch and consumption of fish, or at least until appropriate monitoring verifies that no risk remains through this pathway (i.e., monitoring to verify fish tissue concentrations at an acceptable level).

2.10 Feasibility Study Evaluation Criteria

The overall suitability of a remediation technology for the conditions at any particular CERCLA cleanup site is assessed in the context of nine feasibility study (FS) criteria prior to preparing a detailed remedial design (RD) and actually constructing the remedy. The following sections describe the generally anticipated performance of AquaBlok® as a contaminated sediment remediation technology relative to each of these criteria. In general, capping, along with dredging, is a commonly accepted standard approach for addressing contaminated subaqueous sediments. Given this, it stands to reason that capping is generally characteristically feasible when evaluated in the context of the CERCLA feasibility criteria.

2.10.1 Overall Protection of Human Health and the Environment

Contaminated subaqueous sediments generally create unacceptable risk in three ways. The first is a general environmental health risk associated with the potential for degradation of aquatic or nearshore habitat resulting from the presence of contamination in sediment. The second is human health risk associated with potential direct human contact with and/or incidental ingestion of contaminated sediment and/or surface water

containing contamination emanating from the sediment. The third, and generally most critical from a risk management standpoint for typical contaminated sediment sites, is associated with the potential for ecological receptors to be exposed to contamination in the sediment either through direct contact with and/or incidental ingestion of contaminated sediment and/or contamination in surface water emanating from the sediment, and/or feeding on lower trophic-level organisms that themselves are exposed to contamination in the sediment and/or surface water. Subsequently, a risk to human health can be posed by consuming organisms potentially impacted in this manner.

The AquaBlok® sediment capping technology is designed to isolate sediment contamination from the overlying water column, effectively eliminating the source of contaminant exposure. A concern at most if not all contaminated sediment sites is the likelihood that bioturbation or some other physical or ecological mechanism could mix contamination into the clean cap interval.

Compared to other common capping materials used at contaminated sediment sites (e.g., sand or clean sediment), it is possible that AquaBlok® would yield a lower probability of mixing given its cohesiveness. Alternatively, it is possible that deploying an AquaBlok® cap could upset a site-specific ecological balance by placing a substantially thick and ecologically “inert” layer over the native sediment, or by replacing a coarser grained substrate to which native flora and fauna have adapted with a clay material substrate. This latter potential impact could be overcome by using other materials as part of a composite cap (e.g., by covering AquaBlok® with sand).

Overall, in the context specifically of isolating contamination, AquaBlok® would be anticipated to provide for the overall protection of human health and the environment, and perhaps to a greater degree than other more commonly used capping materials (e.g., sand or clean sediment) given its specific design. With respect to physical effects on the environment, any capping remedy would need to be evaluated in the specific context of compatibility with existing conditions.

2.10.2 Compliance with Applicable or Relevant and Appropriate Requirements

Applicable or relevant and appropriate requirements (ARARs) for a contaminated sediment cleanup action are generally more numerous for dredging and the disposition of removed sediment than capping. However, there are a number of ARARs that are typically pertinent to sediment capping approaches, including water quality standards and biological resource protection standards that may be applicable both during and after cap placement. While certain areas do have promulgated sediment cleanup standards, remediation goals are generally developed for a particular site to protect human and/or ecological receptors on the basis of risk assessments, and are not generally ARARs in and of themselves.

Overall, it is anticipated that an AquaBlok® cap could be designed for any particular sediment cleanup site where this technology would be well suited to be compliant with all pertinent ARARs.

2.10.3 Long-Term Effectiveness and Permanence

With an AquaBlok® sediment capping approach, contaminated sediment would remain in place, but would be covered by an impermeable and continuous isolation barrier that would mitigate against human health and ecological risks. In addition, it is highly likely that any sediment capping remedy would be accompanied by the execution and maintenance of ICs. To ensure the integrity of such a remedy, a long-term monitoring plan would typically be required in addition to a maintenance plan specifying repair requirements to ensure continued remedy effectiveness.

As described in Section 2.10.1, a concern at most if not all contaminated sediment sites is the likelihood that bioturbation or some other mechanism could mix contamination into the clean cap interval. Compared to other common capping materials used at contaminated sediment sites (e.g., sand or clean sediment), it is possible

that AquaBlok® would yield a lower probability of this phenomenon given its cohesiveness and subsequent resistance to mixing. In addition, AquaBlok® is generally highly resistant to erosion given its composition, and would likely therefore be more stable than traditional sand capping material in environments with high flow and shear energy. Similarly, given its composition, AquaBlok® would potentially be more effective over a wider range of geomorphologic conditions. For instance, relative to sand, AquaBlok® would likely be more stable on steeper slopes.

However, it is possible that deploying an AquaBlok® cap could upset a site-specific ecological balance by covering existing benthos or by replacing a coarser grained substrate to which native flora and fauna have adapted, and therefore may be ineffective in maintaining or sustaining a viable ecological setting. Alternatively, given its grain size composition is predominantly more similar to the sediment encountered at most contaminated sediment sites (i.e., fine-grained), AquaBlok® may be more effective at promoting the restoration of ecological equilibrium following capping compared to a more traditional capping material such as sand.

Overall, in the context specifically of its ability to isolate contamination, AquaBlok® is an alternative that would be anticipated to be highly effective in the long-term, and perhaps to a greater degree than other more commonly used capping materials (e.g., sand or clean sediment) given its erosion resistance, physical stability, and impermeability.

2.10.4 Reduction of Toxicity, Mobility, and Volume through Treatment

An AquaBlok® sediment cap would cover contaminated sediments left in place. While there are formulations of AquaBlok® currently under development that could accomplish some level of in situ treatment by integrating reactive components, the common formulation of AquaBlok® discussed in this ITER would not lead to any type of treatment of contamination in the sediment other than potentially simple adsorption of certain contaminants that have an affinity for a

clay matrix. Rather, AquaBlok® would be used for simple isolation of sediment contamination and elimination of the source of exposure to human or ecological receptors through transport to the water column. The volume of contamination would therefore not likely be materially affected directly by the presence of AquaBlok®. However, while treatment would not be responsible, per se, the toxicity and mobility of sediment contaminants would be reduced by directly eliminating the pathway between contamination and receptors. Also, in many respects (i.e., as relates to the low permeability, cohesiveness, and erosion resistance of the AquaBlok® material), AquaBlok® could potentially reduce toxicity and mobility of contaminants to a greater degree compared to more common capping materials (e.g., sand or clean sediment) by more effectively isolating contaminants and therefore providing more “contact” between contamination and active degradation mechanisms in the contaminated sediment interval.

2.10.5 Short-Term Effectiveness

The short-term effectiveness of a remediation technology is generally measured relative to its short-term impacts on the environment and risk to the community during construction.

For an AquaBlok® sediment cap, deployment would likely occur over a relatively short duration, although construction duration for any sediment capping technology would be predicated on the area over which a cap would be placed, the design specifications of the cap (e.g., thickness), and/or the geotechnical properties of the contaminated sediment (e.g., compression strength). Construction activities would likely be limited to the water or the nearshore terrestrial environment, meaning that there would be little risk of exposing the community to short-term implementation hazards.

As is generally true for any capping project, the most significant short-term risks associated with an AquaBlok® sediment cap would be associated with transporting material and equipment to a site and physically placing the cap. A capping remedy would lead to increased traffic to a site

for some duration, which could lead to short-term risk to the community and/or environment (i.e., by increased barge traffic through navigable aquatic environments or increased truck traffic between suppliers and a site). Placing an AquaBlok® cap could lead to disturbance of aqueous habitat or short-term impacts to ecological receptors from equipment operation, suspension of sediment, and alterations to general geochemical surface water quality (e.g., dissolved oxygen [DO]). Placing an AquaBlok® cap could also suspend contaminated sediment for some period of time. In addition, workers involved in constructing an AquaBlok® cap (or any sediment cap) would be exposed to work hazards associated with work on water that are unique relative to more common terrestrial cleanup work.

The construction duration for an AquaBlok® sediment capping approach, or any other sediment capping approach, would likely be short (assuming cap placement over a limited sediment area) and would likely be characterized by a localized construction area. In addition, there are numerous best management practices (BMPs) and mitigation strategies that would limit the short-term risks of an AquaBlok® or any other sediment capping approach. For instance, silt curtains could be deployed and water quality monitoring conducted during cap placement to minimize the potential to adversely impact ecological receptors. Workers would be protected against hazards by a HASP as they would at any hazardous waste site. Given that contaminated sediments would remain in place and be covered there would be a very low overall risk of being exposed to site contamination. Overall, therefore, the anticipated short-term effectiveness of an AquaBlok® sediment capping approach would be high.

2.10.6 Implementability

In general, all materials and equipment needed to deploy an AquaBlok® sediment cap are readily obtainable. In addition, the methods used to construct, maintain, and monitor an AquaBlok® cap are all generally standard, as are the mechanisms typically used to execute and maintain ICs. Overall, the implementability of an AquaBlok® cap at any particular contaminated

sediment site would generally be anticipated to be high.

2.10.7 Cost

Capping, along with dredging, is typically considered the standard remedial approach for contaminated sediment sites. These methods are considered standard sediment cleanup strategies in part because they are the most cost-effective methods for addressing the variable mixture of contaminants typically found in contaminated sediments and because there is a general lack of available and proven in situ treatment alternatives in such cases.

Relative to other typical sediment capping materials (e.g., sand), AquaBlok® would tend to be more costly. However, as indicated in Section 1.2, an AquaBlok® cap could potentially require less thickness to achieve RAOs given its impermeability and other physical characteristics, which could offset some of the additional cost of the material itself. A detailed economic analysis for the AquaBlok® sediment capping technology is provided in Section 4.0.

2.10.8 State Acceptance

AquaBlok® was included in the ROD for the Eagle River Flats Superfund site in Alaska for the in situ management of impacted sediments. Since that time, AquaBlok® has, according to vendor-supplied information, been successfully deployed as a sediment remediation technology at 10 remediation sites, and has been evaluated at bench-scale at several others. Because State acceptance for this technology would likely be related to the effectiveness of the AquaBlok® material at providing contaminant isolation, it is anticipated that the material would be regarded favorably as a suitable capping alternative.

2.10.9 Community Acceptance

AquaBlok® would potentially be an attractive and desirable capping option in the eyes of the community for any given sediment cleanup site given its impermeability and long-term stability. In comparison to other traditional capping materials (e.g., sand and clean sediment), it may even be considered more desirable in the context

of these characteristics. In addition, the perception that AquaBlok® is a more specifically engineered capping material compared to sand or other sediment could play a part in community acceptance.

Overall protection of human health and the environment and compliance with ARARs are considered threshold criteria, in that any remedy must meet these to be considered appropriate. The remaining criteria other than state and community acceptance are considered balancing criteria that allow remedial alternatives to be differentiated from one another. State and community acceptance are considered modifying criteria generally summarized in remediation decision documents.

Table 2-1 summarizes the evaluation of AquaBlok® against the nine CERCLA FS evaluation criteria, in the context of its anticipated performance compared to a sand-only sediment cap.

2.11 Permitting

The applicability of specific permit programs for installing an AquaBlok® cap at a contaminated sediment site would be dependent on the type of waste, the habitat, receptors, and environmental setting at the site, and the federal, state, and/or local environmental laws, regulations, and ordinances in place. For a CERCLA capping remedial action, an ARARs determination would be made to define the universe of federal, state, and/or local environmental laws, regulations, and ordinances that would guide the remedy execution. For a non-CERCLA capping action at a contaminated sediment site, a process similar to an ARARs determination would be executed to determine applicable laws, regulations, ordinances, and permits. It is likely that the specific ARARs identified for any capping remedy at any particular site would be largely identical.

Table 2-1. Summary of AquaBlok® Performance Expectations Relative to CERCLA Feasibility Criteria

CERCLA Criterion	Protective of Human Health and the Environment	Compliant with ARARs	Long-term Effectiveness and Permanence	Reduction of Toxicity, Mobility, and Volume through Treatment	Short-term Effectiveness	Implementability	Cost	State Acceptance	Community Acceptance
Key Factors Influencing Determination, Ranking, or Probability	<ul style="list-style-type: none"> -Not specific to any type of contaminant or degree of contamination -Low permeability -Highly cohesive and stable -Lower potential for bioturbation mixing -Potential for ecological impacts 	<ul style="list-style-type: none"> -Potential applicability of water quality standards and/or resource protection standards -Permit programs 	<ul style="list-style-type: none"> -Highly stable and resistant to erosion -Effective long-term maintenance and monitoring -Institutional controls to protect receptors -Potential for ecological impacts 	<ul style="list-style-type: none"> -No treatment per se (without incorporation of reactive amendments or combination with other technologies) -Toxicity and mobility reduction through isolation and sorption 	<ul style="list-style-type: none"> -Increased traffic for transportation of materials and equipment -Likely a limited construction area -Potential for habitat impacts -Potential for sediment resuspension -Best management practices 	<ul style="list-style-type: none"> -Readily available equipment and materials -Standard methods for construction and monitoring -Institutional controls generally easily implemented and maintained 	<ul style="list-style-type: none"> -Size of capping area -Nature and extent of monitoring and maintenance requirements 	<ul style="list-style-type: none"> -Sensitivity of habitat -Recreational or other value of site -Contaminant isolation capacity relative to contaminant type, distribution, and concentration 	<ul style="list-style-type: none"> -Sensitivity of habitat -Recreational or other value of site -Contaminant isolation capacity relative to contaminant type, distribution, and concentration
Anticipated Performance Relative to Sand-only Cap of Similar Thickness	SAME TO HIGHER	SAME	HIGHER	SAME TO HIGHER	SAME	SAME	SAME TO HIGHER	SAME TO HIGHER	SAME TO HIGHER

Section 3 Technology Effectiveness

This section discusses the SITE demonstration that was conducted to evaluate the effectiveness of the AquaBlok® sediment capping technology at pilot-scale at a contaminated sediment site. It describes the site where the AquaBlok® capping technology was demonstrated, the physical construction of the AquaBlok® cap (and other cap types) evaluated, the measurements and data acquisition that were completed to evaluate the effectiveness of the AquaBlok® cap, and the overall results of the demonstration.

This section is structured as follows: Section 3.1 describes the SITE demonstration program and its physical location and environmental setting; Section 3.2 describes the SITE demonstration approach and methodologies in general and specific terms; and Section 3.3 describes and summarizes the SITE demonstration results. The reader can advance directly to Section 3.3 to read about the SITE program results only.

3.1 AquaBlok® SITE Demonstration Program Description

The Anacostia River is a freshwater tidal river system flowing approximately 8.5 miles (mi) from Prince George's County in Maryland, through Washington, DC, to its confluence with the Potomac River at Hains Point, draining nearly 180 square miles (mi²) in Maryland and Washington, DC. Flow in the Anacostia River is generally considered "sluggish", with mean annual discharge of approximately 1,000 gallons (gal) per second (gal/sec). Hydrologic records available since 1986 indicate a minimum discharge of approximately 13 gal/sec and a maximum of over 230,000 gal/sec in the Anacostia River. The Anacostia River watershed is within the larger Potomac River Drainage Basin, which in turn empties to Chesapeake Bay. Figure 3-1 shows the Anacostia River watershed

and the larger Potomac River/ Chesapeake Bay system.

Sediments in the Anacostia River are contaminated with polycyclic aromatic hydrocarbons (PAHs), polychlorinated biphenyls (PCBs), heavy metals, and other chemicals to levels that have hindered commercial, industrial, and recreational uses. Stretches of the Anacostia River are listed on the National Priorities List (NPL) of Superfund sites (i.e., CERCLA) due to the levels of contamination, habitat degradation, and risks posed to human health and the environment. The most likely sources of contamination in the Anacostia River are historical and/or present widespread industrial activity, diffuse urban runoff, direct discharge of untreated sewage, and military activity.

Given the economic, logistical, technological, and ecological limitations of sediment removal and treatment technologies for the conditions typically encountered in the Anacostia River, sediment capping has the potential to afford significant advantages for contaminated sediment management. Accordingly, EPA, in cooperation with the Louisiana State University (LSU) Hazardous Substance Research Center (HSRC) and the Anacostia Watershed Toxics Alliance (AWTA), implemented an investigation of innovative capping technologies for their use in the management of contaminated sediments in the Anacostia River.

AWTA, formed in March 1999 as a voluntary partnership to focus on addressing toxic sediment contamination of the tidal Anacostia River, is led by EPA Region 3, and includes potentially responsible parties, regulatory agencies including EPA and the National Park Service, the United States Navy (Navy), and several industrial

The Anacostia Watershed

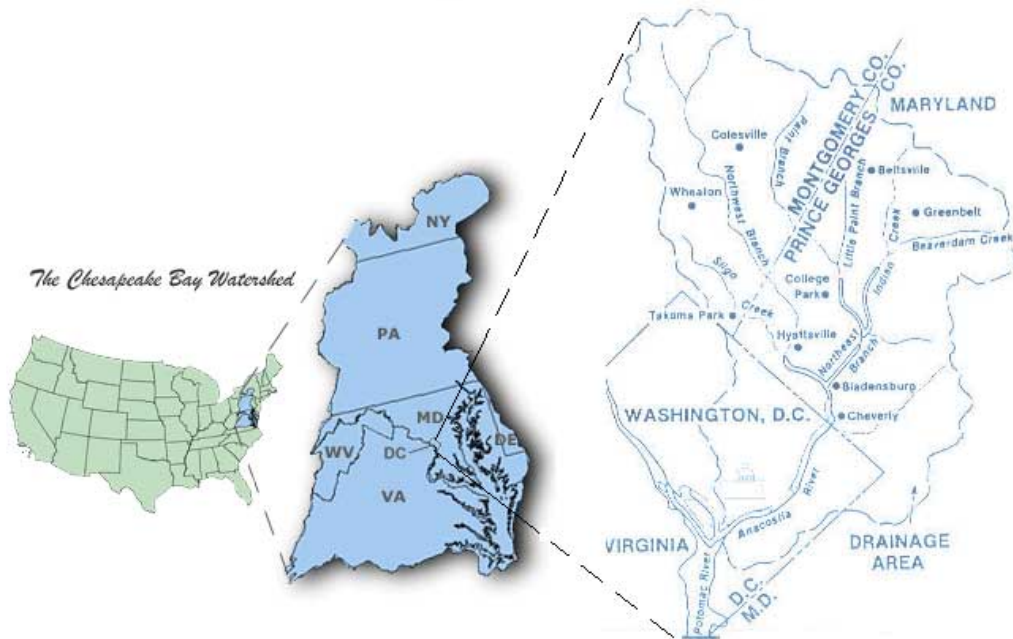

Figure 3-1. Anacostia River Watershed (Anacostia Watershed Society, 2007)

entities for whom this demonstration may help determine the extent to which capping can be employed for remediation and as a blueprint for further river restoration. AWTA is concerned with the entire Anacostia watershed in the context of monitoring contamination and developing a plan to restore the river for recreational use. The AWTA mission statement is as follows: “to work together in good faith as partners to evaluate the presence, sources, and impacts of chemical contaminants on the Anacostia River with all stakeholders, both public and private, and other interested parties, and to evaluate and take actions to enhance the restoration of the river to its beneficial use to the community and ecosystem as a whole.”

HSRC, in collaboration with several other research organizations including the University of New Hampshire (UNH), was tasked with implementing an investigation of three innovative cap materials in the Anacostia River, namely AquaBlok[®], coke breeze (a byproduct of coke manufacture with the potential to sequester and retard the migration of organic contaminants

through sorption), and apatite (a family of phosphate minerals with the potential to sequester metals through sorption). Federal funding was designated to HSRC to evaluate these innovative capping materials in a bench-scale laboratory setting and in the field at pilot-scale.

EPA NRMRL joined as a collaborator in the investigation by funding a specific demonstration of the AquaBlok[®] capping technology through the SITE program. The AquaBlok[®] SITE demonstration program was conducted essentially as an extension of the HSRC study. Although both studies were financially and contractually independent, the SITE and HSRC investigations were coordinated so that both could occur simultaneously and avoid redundancies and/or conflicts. The SITE and HSRC studies were also coordinated so that the results of both capping studies would be comparable. This level of coordination required close communication between the SITE team (i.e., EPA and its lead investigative contractor, Battelle Memorial Institute [Battelle]), HSRC and

its affiliates, and AWTA to ensure that similar and comparable sampling and measurement techniques, sampling locations, and analytical methods were used, while not exceeding the available EPA SITE budget for the demonstration.

The overall goal of the AquaBlok® SITE demonstration was to evaluate the efficacy of AquaBlok® as a potential tool for the management of contaminated sediments. The evaluation was completed by comparing the performance of AquaBlok® against a traditional sand cap and established control sediments relative to several measurement endpoints.

This ITER discusses only the AquaBlok® SITE demonstration and does not discuss the HSRC study.

3.1.1 AquaBlok® SITE Demonstration Study Area Description and History

Preliminarily, two study areas in the Anacostia River adjacent to the Washington Navy Yard in southeastern Washington, DC were selected for the AquaBlok® SITE demonstration (see Figures 3-2 and 3-3). Study Area 1 is located near the south end of the Washington Navy Yard and northeast of the South Capitol Street Bridge. It is also located immediately offshore of a combined sewer outfall (CSO) at the Washington Area Water and Sewer Authority (WASA) O-Street pumping station facility and immediately upstream of the Earth Conservation Corps (ECC) office that occupies a historical (inactive) surface water pumping station built on piers in the river. Study Area 2 is located in the vicinity of a former manufactured gas plant (MGP) site on the north end of the Washington Navy Yard. Both study areas are outside the navigable channel of the river.

For logistical and budgetary reasons, only Study Area 1 was selected to implement HSRC's federally-funded study of active cap technologies and the EPA SITE demonstration of the AquaBlok® capping technology. Accordingly, throughout this ITER, the demonstration area refers specifically to Study Area 1.

3.1.1.1 Physical and Chemical Setting of AquaBlok® SITE Demonstration.

The demonstration area is characterized by a generally shallow water depth (varying between approximately 4 and 18 feet [ft] below mean lower low water [MLLW] on average), and is tidally influenced. Net surface water flow direction is from the northeast to the southwest, towards the Potomac River, but flow reversals are common in conjunction with high tides. From the shoreline to the navigable Anacostia River channel, riverbed sediments in the demonstration area generally slope at an approximately 4% grade. Baseline flow velocities in the demonstration area are generally in the range of 0.1 to 0.7 ft per second (s) (ft/s). Sediments in the demonstration area generally consist of soft, compressible, highly organic, plastic silty clay to a depth of at least 10 ft below the sediment surface.

Given documented contamination conditions in the Anacostia River, contaminants of concern (COCs) selected for the AquaBlok® SITE demonstration were PAHs, PCBs, and metals. River bottom sediments in the demonstration area are contaminated with total PAH concentrations up to 30 milligrams per kilogram (mg/kg) and total PCB concentrations generally between 6 and 12 mg/kg. Heavy metal contaminants identified in the demonstration area include cadmium (Cd) at concentrations of generally 3 to 6 mg/kg, chromium (Cr) at concentrations of generally 120 to 155 mg/kg, copper (Cu) at concentrations of generally 127 to 207 mg/kg, lead (Pb) at concentrations of generally 351 to 409 mg/kg, mercury (Hg) at concentrations of generally 1.2 to 1.4 mg/kg, and zinc (Zn) at concentrations of generally 512 to 587 mg/kg.

3.1.1.2 AquaBlok® SITE Demonstration Cap Design and Construction.

Figure 3-4 shows the cap study design layout for the demonstration area, including all of the capping areas constructed and assessed during the AquaBlok® SITE demonstration and the HSRC innovative capping technology evaluation. As described in Section 3.1, the SITE demonstration focused on the performance of AquaBlok® while HSRC evaluated the effectiveness of apatite,

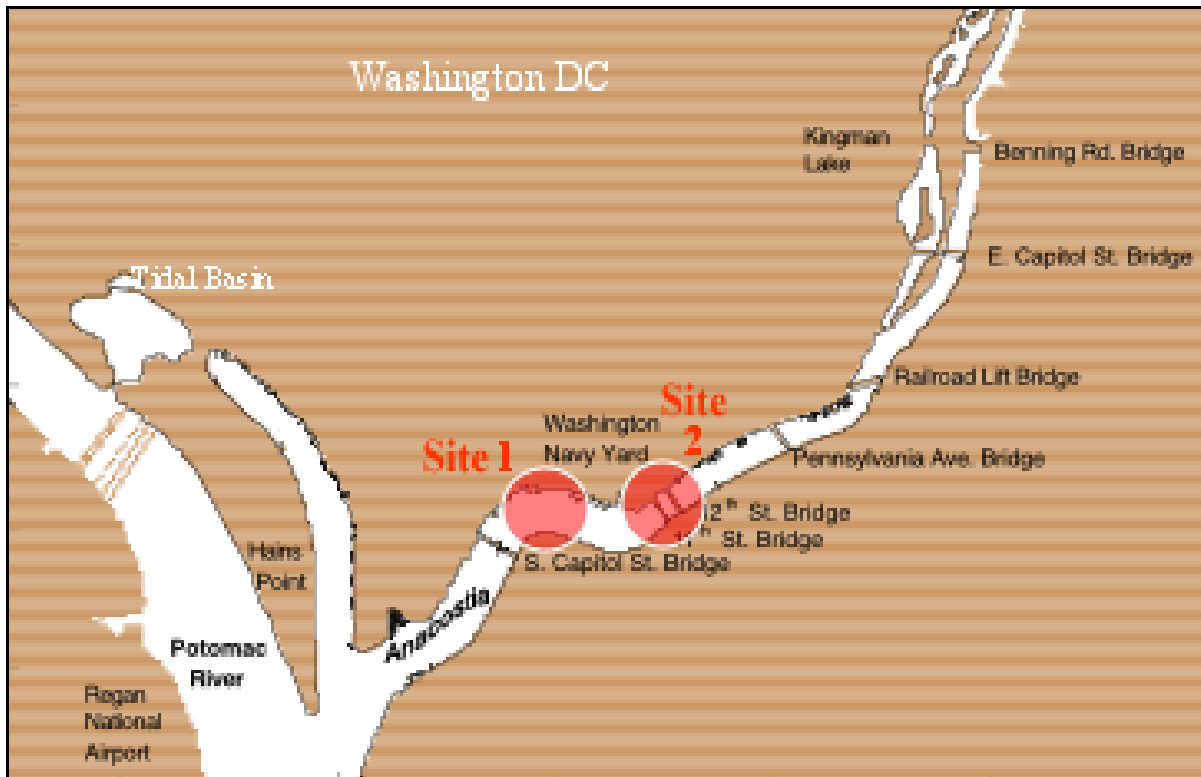

Figure 3-2. Locations of Preliminary AquaBlok® SITE Demonstration Study Areas



Figure 3-3. Aerial Image of Preliminary AquaBlok® SITE Demonstration Study Areas

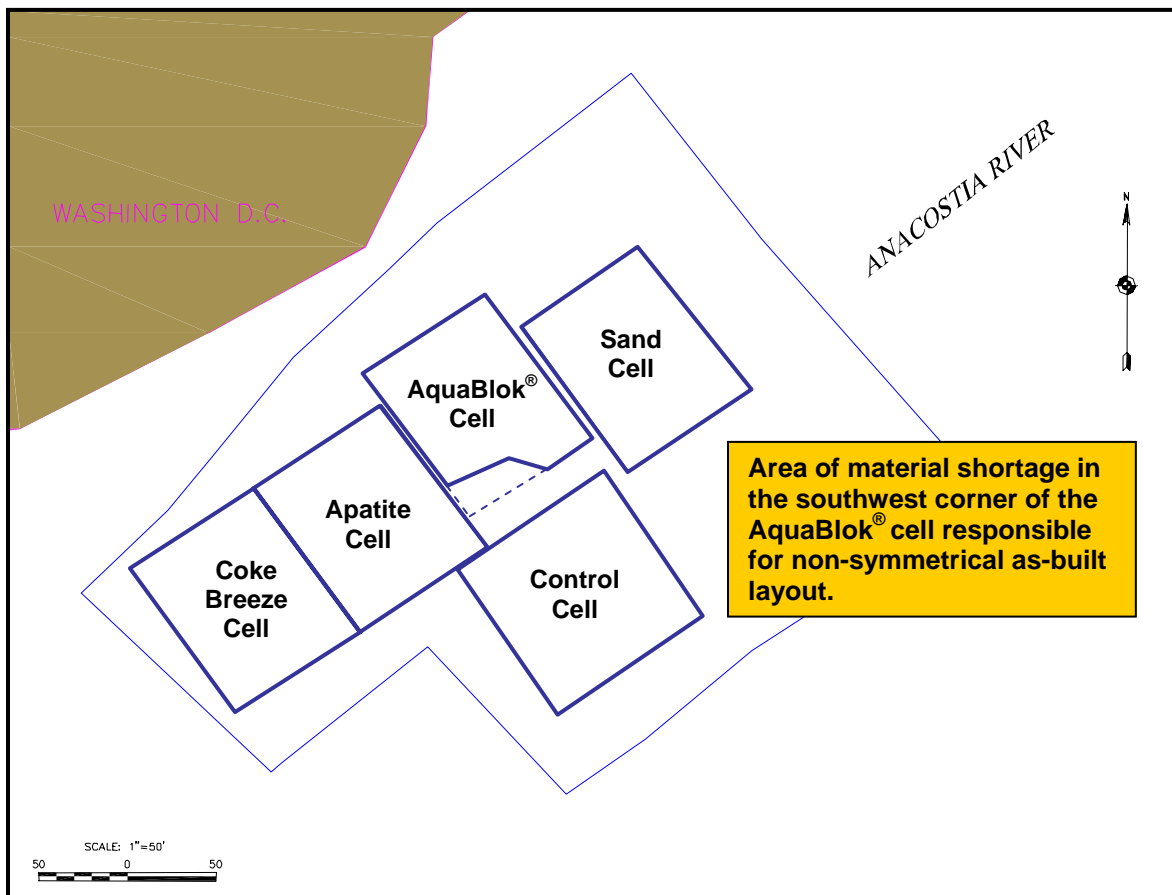

Figure 3-4. AquaBlok® SITE Demonstration Area Capping Cell Layout

coke breeze, and AquaBlok® caps. However, for both studies, a traditional sand cap area was established to serve as a point of comparison between traditional and innovative technologies, and an uncapped control cell was established to provide a baseline for reference comparisons. These areas are also depicted on Figure 3-4.

The sand-only cap was designed to consist of approximately 1 ft (30 centimeters [cm]) of clean sand placed on the contaminated sediment surface. The AquaBlok® cap was designed to consist of approximately 4 inches (in) (10 cm) of AquaBlok® material (after hydration) placed on the contaminated sediment surface and approximately 8 in (20 cm) of clean sand placed atop the AquaBlok® layer. The control sediment area was established immediately offshore of the AquaBlok® and sand cap areas (i.e., in the direction of the navigable river channel). During cap construction, there were tolerances for

acceptable thickness in each capping cell, as summarized in Table 3-1 (Horne Engineering Services, Inc. [Horne], 2004).

Each cap area was designed to cover an area of approximately 100 ft by 100 ft (30.5 meters [m] by 30.5 m), for a total area of 10,000 ft² (930 square meters [m²]). The uncapped control area did not receive any capping treatment, but was selected to cover an area roughly the same size as the capped cells. During cap construction, a collective decision was made by key project personnel (not including Battelle or EPA NRMRL) to limit the sand and AquaBlok® caps to 8,000 ft².

The caps, including AquaBlok®, were constructed by HSRC pursuant to its federally-funded technology evaluation program and independent of the AquaBlok® SITE demonstration. As such, EPA NRMRL and Battelle were not directly involved in the cap construction activities. All

Table 3-1. Capping Cell Construction Design and Tolerances

Cap Cell	Material	Target Thickness (in)	Total Target Thickness (in)	Acceptable Thickness Range (in)	
				Minimum	Maximum
AquaBlok® Cell	AquaBlok®	4 (hydrated)	12	2	8
	Sand	8		4	12
Sand Cell	Sand	12	12	4	14



Figure 3-5. AquaBlok® in 2-Ton SuperSack at Staging Area

necessary authorizations were obtained and work plans developed by HSRC for the cap construction work.

On March 15, 2004, mobilization was completed by HSRC for the construction of the demonstration area capping cells. Materials used to construct the sand and AquaBlok® caps were staged at the General Services Administration (GSA) property adjacent to the Washington Navy Yard under an agreement between HSRC and GSA.

AquaBlok® was delivered by flatbed trailer in a total of 55 palletized SuperSacks (i.e., large plastic bags) with approximately 2-ton capacity (see Figure 3-5). Each bag was unloaded with a

forklift at the GSA property. AquaBlok® bags were placed on and covered with polyethylene sheeting to prevent contact with precipitation because of the highly water-sensitive nature of the product.

Sand was not packaged in any form and was delivered to the GSA site by standard 20-ton dump truck (see Figure 3-6). Approximately 1,355 tons of sand was delivered to the site in 64 truckloads. The sand was delivered both before and during the cap construction period, with deliveries coordinated to coincide with cap placement material requirements.

A loader or forklift was used to transfer the materials stored at the GSA staging area to a



Figure 3-6. Sand Cap Material Stored in Bulk at Staging Area



Figure 3-7. Transferring Cap Material to Barge Using Conveyor



Figure 3-8. Crane Barge Used to Place Caps in Demonstration Area

nearshore loading area. A belt conveyor system was then used to transfer the materials from the nearshore material stockpile area to a material barge secured along the shoreline (see Figure 3-7). After loading, a tugboat was used to move the material barge beside a crane barge that was used to actually construct the caps (see Figure 3-8).

The crane barge was secured using long anchor cable lines attached to anchors deployed outside of the demonstration area to avoid potential impacts to cap integrity. The tugboat was always positioned outside of the capping area to avoid potential propeller scour in the capped areas. The material barge was secured to the crane barge during cap placement.

A two cubic yard (cy) clamshell bucket was used on the crane boom to slowly release materials above the water surface. This clamshell bucket was selected because it could most efficiently

and cost-effectively meet the cap thickness design requirements. Cap material was applied to the target cap areas in a broadcast fashion using a Windows[®]-based version of the Offshore Positioning Software (WINOPS) system for location control. Real-time positioning data from the WINOPS system assisted the crane operator in achieving consistent coverage and proper thickness of cap material across the capping areas.

The actual placement of cap material began on March 17, 2004. The sand cap was placed first, followed by the AquaBlok[®] cap. The cap placement procedures consisted of first retrieving the capping materials from the material barge with the clamshell bucket, moving the clamshell bucket to the desired application location using the WINOPS system, opening the bucket slowly above the water surface and swinging it across the targeted area in an arc to allow even dispersal of cap material, and marking the

application location on the WINOPS monitor. The capping generally started near the shoreline and worked away from the shoreline, parallel to the navigation channel, such that previously capped areas were not disturbed by the capping operations or movements of the capping equipment.

Sand cap placement was completed on March 19, 2004. AquaBlok® cap placement (including the sand cover layer) started on March 22, 2004, and was completed on March 27, 2004. As constructed, the sand cap cell covered approximately 8,000 ft² (743 m²) and the AquaBlok® cap covered approximately 7,200 ft² (680 m²). The AquaBlok® cap footprint was not completed entirely in the southwest cell corner (see Figure 3-4). This was related to a material shortage to achieve the design thickness throughout the capping cell (i.e., more AquaBlok® was placed during initial releases than was needed to achieve the design thickness, leaving less material for subsequent areas). Consequently, the size of the area capped was reduced relative to the original target area. This material shortfall did not compromise the demonstration program.

Silt curtains were deployed during cap placement to create a temporary boundary and reduce the migration of broadcast-applied cap materials and potentially resuspended sediments downstream and/or to other capping cells. The silt curtains also maximized (by limiting dilution) the ability to visually determine any increases in turbidity or potential contaminant levels as a result of resuspension during cap placement activities. The silt curtains were placed from shore to shore (i.e., in an arc) along the outside of the cap perimeter (see Figure 3-9) which eliminated the need for a silt curtain along the shoreline. Silt curtains were also used to separate the various capping cells to minimize cross-contamination between work areas.

There were no project specific compliance requirements for water quality during cap construction. However, water quality monitoring was conducted during the capping operations to verify that turbidity and DO concentrations were maintained within acceptable ambient water

quality criteria. In addition, target contaminants (i.e., metals, PAHs, and PCBs) were analyzed for in surface water samples collected inside the capping material release areas and outside of the silt curtains to evaluate the potential for resuspension of contaminated sediment into the water column. Water quality monitoring was conducted during the cap placement using submersible water quality monitoring equipment (i.e., a multifunction water quality analyzer). All water quality monitoring was performed at a depth of approximately 6 in below the water surface at established monitoring stations. Overall, the monitoring information indicated there was no impact to water quality related to the capping project (Horne, 2004).

3.2 AquaBlok® SITE Demonstration Approach and Methods

The overall goal of the AquaBlok® SITE demonstration was to evaluate the efficacy of AquaBlok® as an innovative remedial approach for management of contaminated sediments. The following specific objectives were identified by EPA NRMRL for study within the context of the AquaBlok® SITE demonstration:

- Objective #1 – Demonstrate the physical stability of an AquaBlok® cap in the Anacostia River under stresses associated with normal river flows and high-flow events, and determine theoretical hydraulic stresses under which the cap could fail. Compare these stabilities with traditional sand capping technology and uncapped (control) sediments.
- Objective #2 – Demonstrate the ability of an AquaBlok® cap to control groundwater seepage influenced by regional gradients or tidal pumping (or both) relative to seepage through sand-capped and uncapped (control) sediments.
- Objective #3 – Demonstrate the influence of an AquaBlok® cap on the benthic flora and fauna expected to populate Anacostia River sediments relative to the influence of sand-capped and uncapped sediments.



Figure 3-9. Silt Curtains Deployed Around Demonstration Area Capping Cells

In parallel with the AquaBlok® SITE demonstration, HSRC conducted an evaluation of AquaBlok® with a unique but complementary set of objectives. As described above, this ITER is intended only to discuss the implementation and results of the AquaBlok® SITE demonstration and not the HSRC study.

A series of field monitoring events were conducted over an approximately three-year period after the caps were placed. A number of investigation tools were used during these events to gather important technology performance data. The results of these various data gathering events form the basis of the conclusions conveyed in this ITER related to the performance of the AquaBlok® sediment capping technology, including the relative performance in comparison to traditional sand-capping technology.

Specifically, field activities were implemented one month following completion of the cap construction, and then at six months, 18 months, and 30 months following cap construction. Accordingly, the first post-capping field event

occurred in the spring of 2004 and the second in the fall of 2004. The remaining events occurred annually thereafter, in the fall of 2005 and 2006.

The critical and non-critical measurements collected for each of the primary AquaBlok® demonstration objectives, the various measurement tools utilized during the four post-

capping monitoring events, and a summary of the principles of and methods employed for each measurement tool are summarized below.

3.2.1 Critical and Non-Critical Measurements

Critical measurements are those that were deemed of fundamental importance or of absolute necessity to fully evaluate a demonstration objective. Non-critical measurements are those that were deemed to provide ancillary or incremental value to understanding a condition or evaluating a demonstration objective. A series of critical and

non-critical measurement endpoints were developed for each of the primary AquaBlok® SITE demonstration objectives, as follows:

- Objective #1 – Demonstrate the physical stability of an AquaBlok® cap.

The physical stability of AquaBlok® in flowing water depends primarily on the material's physical strength (e.g., shear strength) and its ability to withstand shear stresses imposed by surface water flow field currents at the cap/water interface. One of the most critical design characteristics of AquaBlok® is that, given its high degree of cohesiveness related to its material composition, it claims to have a higher resistance to shear energy compared to traditional capping materials (e.g., sand).

Critical Measurements

- Sedflume coring and analysis;
- Sediment coring and analysis of COCs;
- Bathymetry and sub-bottom profiling; and
- Side-scan sonar surveying

Non-Critical Measurements

- Sediment profile imaging (SPI);
 - Gas flux analysis; and
 - Sediment coring and analysis of physical parameters
- Objective #2 – Demonstrate the ability of an AquaBlok® cap to control groundwater seepage.

Tidal forces, regional pumping, or other hydrogeologic phenomena in surface water bodies have the potential to impose significant vertical groundwater gradients into or out of bottom sediments. Measurements collected historically within several areas of the Anacostia River near or in the demonstration area indicate low but quantifiable flow velocities both into and out of the bottom sediments. One of the primary advantages of AquaBlok® is that it claims to significantly reduce permeability, which should be reflected as a reduction in groundwater seepage flows relative to

seepage in sand-capped sediments and uncapped control areas.

Critical Measurements

- Sediment coring and analysis of hydraulic conductivity; and
- Seepage meter testing

Non-critical Measurements

- None
- Objective #3 – Demonstrate the influence of an AquaBlok® cap on benthic flora and fauna.

A key concern in applying AquaBlok® as an innovative sediment capping alternative is the long-term effect of this material on habitat for faunal (benthic) communities, and also on potential habitat for floral communities (which would depend on site-specific water levels and suspended sediment loads as they relate to a favorable setting for emergent and/or submergent vegetation).

According to the material vendor, standard (i.e., non-amended) AquaBlok® material is inherently low in organic content, and is not generally designed specifically to support significant biological growth. However, the grain size of AquaBlok® is similar to sediments generally found at most contaminated sediment sites. In addition, the AquaBlok® cap constructed during the SITE demonstration was covered by a sand layer that would likely support some level of biological growth and allow for a comparison between benthic impacts of the sand-covered AquaBlok® cap and the sand-only cap (e.g., floral and benthic infaunal species impacts such as diversity and richness).

Possible mechanisms by which the basal AquaBlok® layer could potentially affect the overlying sand material as benthic habitat include:

1. The AquaBlok® material could conceivably become entrained into or

mixed with the sand covering layer, thereby altering the surface characteristics of the sand covering the AquaBlok®. Thus, the sand material covering the AquaBlok® cap could behave differently than the sand-only cap due to the entrainment of some of the AquaBlok® material.

2. The AquaBlok® could create a physical and/or relatively organically impoverished barrier to deep burrowing organisms (e.g., organisms that burrow deeper than typical bioturbation depths of approximately 20 cm), thereby possibly affecting the species composition and abundance of such organisms and the diversity of organisms supported in the cap material.
3. Given its more similar grain size relative to native Anacostia River sediments in comparison to sand, AquaBlok® could actually be a more preferential habitat for benthos.

Critical Measurements

- None

Non-Critical Measurements

- Benthic grab sampling and descriptive and statistical benthic assays; and
- Benthic assessment through SPI

These measurement endpoints associated with the primary SITE demonstration objectives are summarized in Table 3-2.

3.2.2 Field Activities

As indicated above, field activities were implemented one month following completion of the cap construction, and then at six months, 18 months, and 30 months following cap construction. Accordingly, the first post-capping field event occurred in the spring of 2004 and the second in the fall of 2004. The remaining events occurred annually thereafter, in the fall of 2005 and 2006.

During each of the post-cap construction field activities, a robust set of field measurement tools were utilized to gather information related to the primary objectives of the AquaBlok® demonstration project, as follows:

One-Month Post-Capping Field Event (Spring 2004)

- Bathymetry and sub-bottom profiling;
- Side-scan sonar surveying;
- SPI; and
- Seepage meter testing

Six-Month Post-Capping Field Event (Fall 2004)

- Bathymetry and sub-bottom profiling;
- SPI;
- Seepage meter testing;
- Sedflume coring and analysis; and
- Sediment coring and analysis of COCs and physical parameters

18-Month Post-Capping Field Event (Fall 2005)

- Bathymetry and sub-bottom profiling;
- Side-scan sonar surveying;
- SPI;
- Seepage meter testing;
- Sediment coring and analysis of COCs, physical parameters, and hydraulic conductivity; and
- Gas flux analysis

30-Month Post-Capping Field Event (Fall 2006)

- Bathymetry and sub-bottom profiling;
- Side-scan sonar surveying;
- SPI;
- Seepage meter testing;
- Sedflume coring and analysis;
- Sediment coring and analysis of COCs, physical parameters, and hydraulic conductivity;
- Gas flux analysis; and
- Benthic grab sampling for descriptive and statistical benthic assays

Table 3-2. Critical and Non-Critical SITE Demonstration Measurements

Demonstration Objective	Measurement	Critical or Non-Critical
Objective #1 Demonstrate the physical stability of an AquaBlok® cap	Sedflume analysis	Critical
	Sediment coring and analysis of COCs	
	Bathymetry and sub-bottom profiling	
	Side-scan sonar surveying	Non-critical
	SPI	
	Gas flux analysis	
Objective #2 Demonstrate the ability of an AquaBlok® cap to control groundwater seepage	Sediment coring and analysis of physical parameters	Critical
	Sediment coring and analysis of hydraulic conductivity	
Objective #3 Demonstrate the influence of an AquaBlok® cap on benthic flora and fauna	Seepage meter testing	Non-critical
	Benthic grab sampling and descriptive and statistical assays	
	SPI	

This matrix of field sampling and monitoring components for the various post-capping field events is summarized in Table 3-3. This table also provides a specific summary of the dates during which the various tools were implemented in the field.

3.2.3 Field Measurement Tools

The following subsections describe the general methods and procedures typically followed to employ the various field investigation and monitoring tools that were used during the AquaBlok® SITE demonstration project. For simplicity, the field investigation and monitoring tools are listed in the same order they appear in Section 3.2.1.

3.2.3.1 Sedflume Coring and Analysis.

Sediment erosion rates typically depend on sediment bulk density, mean grain size, grain size distribution, organic content, and relative cohesiveness. Sediment erosion, however, cannot be accurately predicted through knowledge of such sediment parameters alone, and the relative influences of these parameters tend to vary depending on the nature of any substrata involved. Sedflume technology can be used to determine how the sediment erosion

potential based on these sediment parameters varies spatially across a study area.

To employ Sedflume technology, sediment cores must be collected to obtain intact sediment for testing. Cores in shallow water are typically collected by manual direct-push techniques, while cores in deeper water are typically collected using a vibratory coring unit or comparable mechanical coring method. Coring is most commonly completed from a stable boat platform. Cores collected for Sedflume analysis are typically rectangular box cores. A rectangular, transparent, box-shaped coring sleeve with a nose cone is manually lowered to the sediment bed by a pole (or by the mechanical coring unit). Manual or mechanical pressure is applied to the top of the sleeve and the nose cone. Based on the combined weight of the coring sleeve and the applied pressure, the sleeve penetrates the sediment bed. Upon penetration of the core liner into the sediment bed, flaps on the nose cone open upward and allow sediment to enter the core tube without disturbing the sediment strata. The coring sleeve then is pushed as far as possible into the sediment bed or until a suitable design depth is achieved. The distance of penetration will vary due to the characteristics of the sediment (i.e., greater penetration depth will

Table 3-3. SITE Demonstration Field Program Details

Demonstration Objective	Measurement	Field Event	Date(s)
Objective #1 Demonstrate the physical stability of an AquaBlok® cap	Sedflume analysis	Month 6	9/17/04-9/23/04
		Month 30	10/17/06-10/22/06
	Sediment coring and analysis of COCs	Month 6	9/20/04-9/25/04
		Month 18	9/27/05-9/28/05
		Month 30	10/17/06-10/19/06
	Bathymetry and sub-bottom profiling	Month 1	5/12/04
		Month 6	9/14/04-9/15/04
		Month 18	9/15/05
	Side-scan sonar surveying	Month 30	9/19/06
		Month 1	5/11/04
		Month 18	9/14/05
	SPI	Month 30	9/20/06
		Month 1	5/13/04-5/14/04
		Month 6	9/16/04
	Gas flux analysis	Month 18	9/16/05
		Month 30	9/20/06-9/21/06
		Month 18	8/25/05-9/26/05
	Sediment coring and analysis of physical parameters	Month 30	8/14/06-9/13/06
Month 6		9/20/04-9/25/04	
Month 18		9/27/05-9/28/05	
Objective #2 Demonstrate the ability of an AquaBlok® cap to control groundwater seepage	Sediment coring and analysis of hydraulic conductivity	Month 30	10/17/06-10/19/06
		Month 18	9/27/05-9/28/05
	Seepage meter testing	Month 1	5/17/04-5/22/04
		Month 6	9/27/04-10/7/204
Objective #3 Demonstrate the influence of an AquaBlok® cap on benthic flora and fauna	Benthic grab sampling and descriptive and statistical assays	Month 18	9/19/05-9/23/05
		Month 30	9/25/06-9/30/06
	SPI	Month 1	5/13/04-5/14/04
		Month 6	9/16/04
		Month 18	9/16/05
		Month 30	9/20/06-9/21/06

tend to occur in a softer sediment than in a more consolidated sediment). When the core sleeve is lifted from the sediment bed, the nose cone flaps close to retain the sediment core. The coring sleeve is retrieved, the nose cone is removed, a plug is inserted into the bottom of the sleeve to seal the core and later to act as a piston head, and the core is capped.

A detailed description of Sedflume and its application is provided in McNeil and Lick (1996). A Sedflume is essentially a straight flume (see Figure 3-10) with a test section containing an open bottom through which the rectangular cross-

section coring sleeve containing sediment is inserted. The main components of the flume are the coring sleeve, a test section where the coring sleeve is advanced, a water storage tank, a pump to force water through the system, an inlet for the introduction of uniform, fully-developed, turbulent flow, and a flow exit section. The Sedflume system, as with the coring sleeve, is generally constructed of a transparent material so that sediment-water interactions can be directly observed. Water is pumped from the water storage tank, through a pipe, and then through a flow converter into the rectangular duct shown on Figure 3-10.

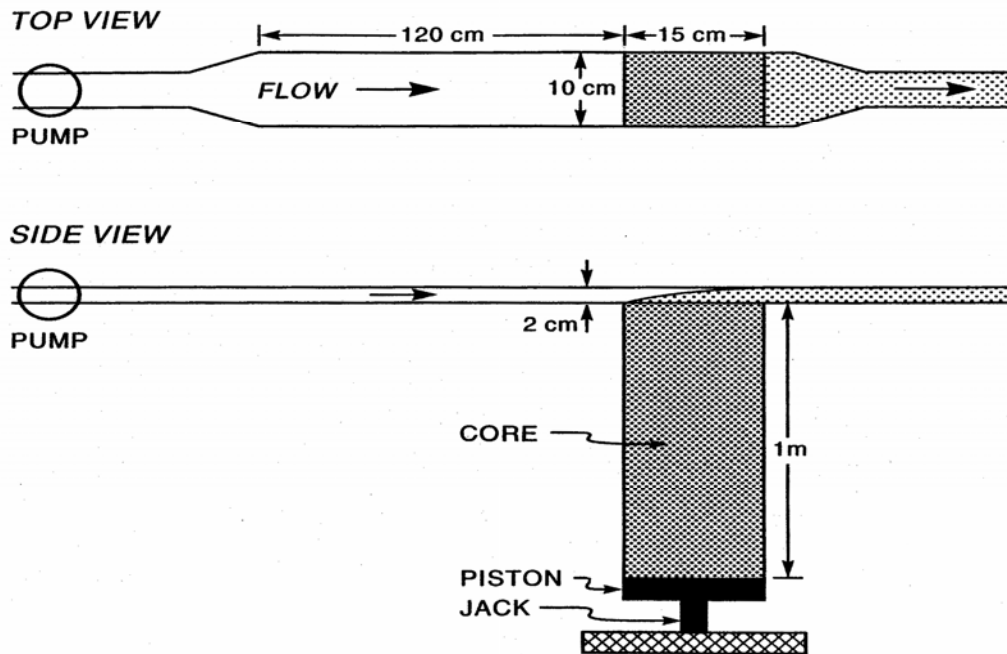

Figure 3-10. Sedflume Schematic (from McNeil and Lick, 1996)

This duct is generally 2 cm in height, 10 cm in width, and 120 cm in length, and contains the test section, which receives the box shaped core sleeve with test sediment. The flow converter changes the flow field shape from the water holding tank from a circular cross-section to the rectangular duct shape while maintaining a constant cross-sectional area. A three-way valve regulates the flow so that an appropriate component of the flow enters the duct while the remainder returns to the tank. Also, a small valve in the duct immediately downstream of the test section can be opened at higher flow rates to maintain the pressure in the duct and over the test section at atmospheric conditions.

At the start of each test, the coring sleeve and the sediment it contains are inserted into the bottom of the test section. An operator moves the sediment upward using the piston plate placed inside the coring sleeve during core retrieval that is subsequently connected to a hydraulic jack. The jack is driven by hydraulic pressure that is regulated with a switch and valve system. By this means, the test sediments can be raised and made to enter the test section. The speed of the

jack movement can be controlled at a variable rate in measurable increments generally as small as 0.5 millimeters (mm).

Water is forced through the duct and the test section and over the surface of the test sediments. The shear produced by this flow causes the sediments to erode. As the sediments extruded from the core sleeve erode, the core is continually moved upward by the operator so that the sediment-water interface remains level with the bottom of the test and inlet sections (a few millimeters of the core does protrude above the section floor). The erosion rate is recorded as the degree of upward movement of the sediments in the coring tube over time.

Measuring the erosion rate of the sediments as a function of shear stress and depth is generally made by running the flume at a specific flow rate corresponding to a particular shear stress. Erosion rates are obtained by measuring the remaining core length at different time intervals recorded with a stopwatch and dividing the difference in successive measurements by the

time interval between the measurements. Shear stress is then calculated using the measured erosion rates and corresponding flume hydraulic flow rates, as reported in McNeil and Lick (1996).

To measure erosion rates at several different shear stresses using only one core, an iterative procedure is used. Starting at a relatively low shear stress, the flume is run sequentially at higher shear stresses with each succeeding shear stress generally being twice the previous. Generally, about three shear stress intervals are run sequentially. Each shear stress interval is run generally until at least 2 to 3 mm but no more than 2 cm of test sediment are eroded from the test core. The flow then is increased to the next shear stress interval, and so on until the highest shear stress is run. Thus, flows are varied incrementally, but held statically at each graduated interval to observe and measure sediment shear. After a particular interval is complete, the piston elevates the core so that the surface is in direct contact with the flume once again. The intervals are repeated until all of the sediment has eroded from the test core. If after three cycles at a particular shear stress interval an erosion rate of less than 10^{-4} cm/s is calculated, that particular stress value is not considered relevant to the test. Alternatively, if after many cycles the calculated erosion rates decrease significantly, higher shear stress intervals will be introduced.

A critical shear stress can be quantitatively defined as the shear stress at which a very small but accurately measurable rate of erosion occurs. As indicated above, this rate of erosion is generally chosen to be 10^{-4} cm/s, which typically represents 1 mm of erosion in approximately 15 minutes. It would be difficult to measure all critical shear stresses at exactly 10^{-4} cm/s, so erosion rates are generally measured above and below 10^{-4} cm/s at shear stresses which differ by a factor of two. The critical shear stress then is linearly interpolated to an erosion rate of 10^{-4} cm/s. Critical shear stress is then a function of the erosion rate measured as a function of depth. The following equation (Gailani et al., 2001) describes the erosion rate E (cm/s) as a function of the shear stress τ (Newtons per square meter [N/m^2]) and the bulk density ρ (gram per cubic

centimeter [g/cm^3]) and where A , n , and m are constants related to bulk sediment properties:

$$E = A\tau^n\rho^m \quad (3-1)$$

3.2.3.2 Sediment Coring and Analysis of Contaminants of Concern. To determine physical characteristics of sediments, as well as levels of contaminants present in those sediments, sediment coring is a frequently utilized sediment investigation tool. Typically, a pontoon boat or comparable vessel is used as the sampling platform during sediment coring. The techniques used for sediment coring include vibratory coring, piston coring, or manual direct-push coring.

An accurate global positioning system (GPS) on the coring vessel is used to define spatial coordinates for each core sampling location, or spatial coordinates are determined prior to coring and uploaded to the GPS system to accurately locate these positions. Once on station, the coring vessel is held in position using some positioning device (e.g., anchors, spuds, or tie-lines) and the manual or mechanical coring device is lowered to the sediment surface and pushed into the sediment to capture a vertical sediment core. In sediment coring work, some type of circular, clear core liner (e.g., butyrate) and a cutter head are typically used inside the coring device. The cutter head facilitates core penetration and minimizes sediment loss during core retrieval, and the core liner is used to contain the intact core and can later be cut to produce vertical interval samples for laboratory analysis.

When the sediment cores are brought to the surface, the sediment is contained within the clear sediment core liner, which is typically capped and stored vertically until the core is processed in an appropriate fashion either onboard the coring vessel or at a landside processing location. Sediment can be visually assessed in the core liner, or extruded from the core liner, inspected, and various sampling intervals transferred to appropriate sample container(s) for laboratory analysis using appropriate analytical methods.

3.2.3.3 Bathymetry and Sub-Bottom Profiling.

Bathymetry is a method of collecting accurate water depth information from across a study area to understand sediment surface topography and sediment slope. Given that the surface of a water body can be considered a static horizontal feature, water depth can be considered a surrogate for sediment bed elevation. In addition, bathymetry collected over successive monitoring episodes can be compared and provide an understanding of the net change in sediment topography over time.

Bathymetric data are commonly collected by following a series of parallel survey lines in a survey vessel equipped with a survey-grade (i.e., high-precision) depth sounding instrument. Depth sounding instruments function on the principle of sound wave propagation by sending a sound pulse (typically at an inaudible frequency) to the sediment surface and receiving the return signal from this pulse after reflection. The time between signal generation and signal return is geometrically proportional to water depth (after correction for attenuation) and is recorded either digitally or on a paper scroll by the depth sounder device.

Sub-bottom profiling is a method of determining the specific thickness of multiple layers of subaqueous material. Acoustic sub-bottom profiling of sediments, like bathymetry, makes use of reflected sound waves from different subsurface sediment layers (see Figure 3-11). Sediment layers that exhibit different properties of elasticity and density can sometimes be distinguished as distinct layers within an acoustic signal profile.

Sub-bottom profiling is frequently conducted using a high-resolution subsurface profiler capable of full-spectrum frequency modulation (FM), also known as a “Chirp” profiler. As with bathymetry, sub-bottom profiling data are generally collected from a survey vessel along a series of parallel survey lines. The principle of sub-bottom profiling is similar to bathymetry, in that an acoustic signal is generated and returned to the instrument, allowing for a calculation of depth based on travel time. However, the “Chirp” profiler emits a signal in a frequency band rather

than a single frequency. The variable frequency emission allows subsurface penetration and resolution of different reflective layers based on sediment lithology and the varying return times of the varying frequencies and varying degrees of penetration. Subsurface reflectors (indicating different sediment depositional layers) can then be digitized to produce maps of sediment thickness with distinct lithologic layers.

3.2.3.4 Side-Scan Sonar. Side-scan sonar works by transmitting sound waves to subaqueous sediments at an angle. The sound waves are emitted by a submerged device towed by a survey vessel called a “towfish”, which can be positioned nearer the sediment surface to minimize signal attenuation in the water. Acoustic signals bounce off the sediment surface and are then detected as a return by the side-scan sonar instrument. The strength of the return echo is continuously recorded and varies on the basis of sediment surface texture, regularity, and other parameters, which creates a virtual picture or map of the sediment surface. Objects or features that protrude from the bottom will tend to yield a stronger signal, creating a relatively dark image. The output of a side-scan sonar survey is typically a plan view map with an appearance analogous to an aerial photograph. Side-scan sonar data are generally collected along a parallel series of survey lines. However, given the generally wider range of the acoustic signal emitted from a side-scan sonar “towfish” relative to bathymetry and sub-bottom profiling, the survey line spacing for side-scan sonar can generally be less dense.

Like bathymetry and sub-bottom profiling, side-scan sonar data collected over successive monitoring episodes can be compared and provide an understanding of the net change in a sediment surface over time.

3.2.3.5 Sediment Profile Imaging. A sediment profiling camera can be used to visually inspect sediment for stability, uniformity, layering, and other important characteristics. SPI involves the deployment of a highly specialized camera from a vessel and the penetration of the camera into the subaqueous sediment. The sediment profile camera essentially works like an

Diagram of acoustic subbottom profiling

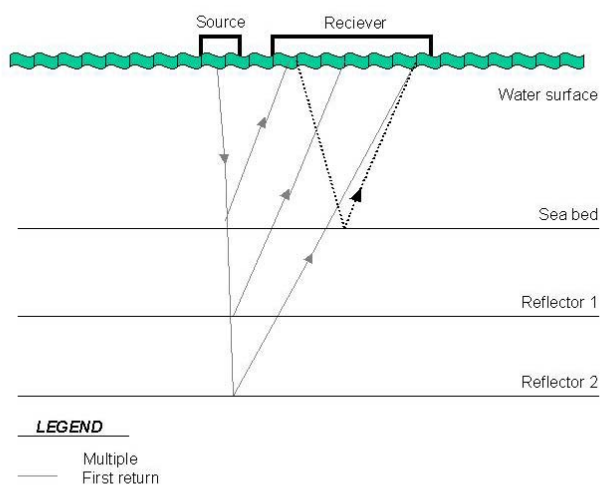

Sound produced at the source reflects off of the seabed surface, reflector 1, and reflector 2, which are areas of rapid density change. The receiver catches the reflected sound waves. A multiple sound wave is received at the same time as the reflector two sound wave, obscuring reflector 2 on the same seismic record.

Figure 3-11. Principles of Acoustic Sub-Bottom Profiling

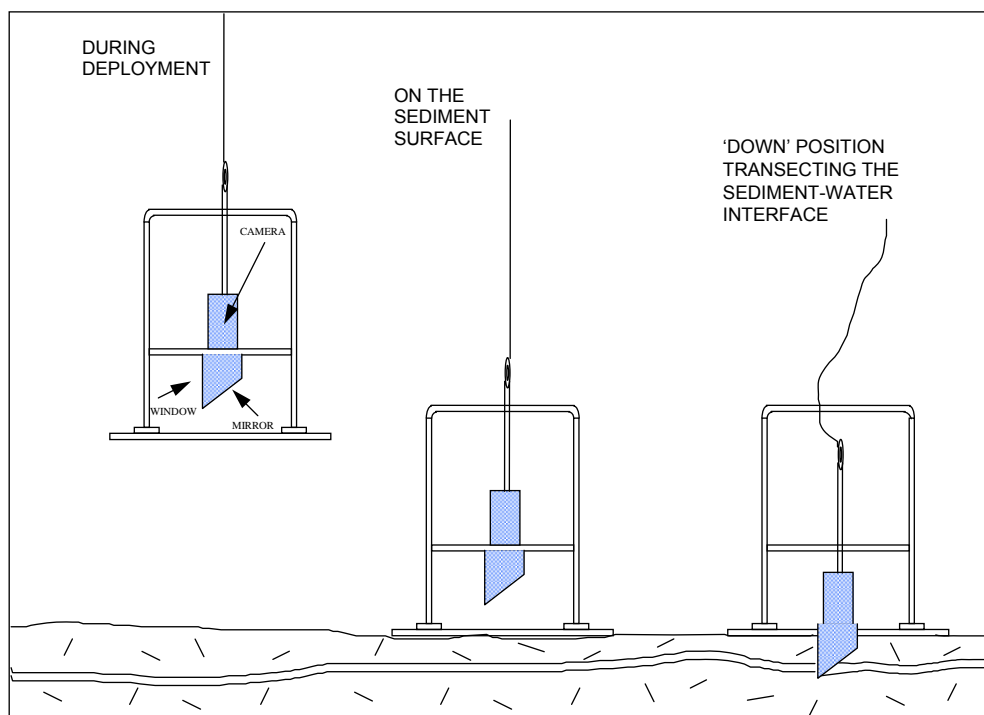

Figure 3-12. Schematic of Sediment Profiling Camera

inverted periscope. A camera is mounted horizontally on top of a wedge-shaped, knife-sharp prism. The prism has a clear, optically transparent faceplate at the front with a mirror placed at a 45° angle at the back. The camera lens looks down at the mirror that reflects the image from the faceplate. The prism penetrates the subaqueous sediment to capture a real-time image of a relatively undisturbed profile of the sediment.

The prism has an internal strobe mounted inside at the back of the wedge to provide illumination for the image. The prism chamber is filled with distilled water so the camera maintains an optically clear exposure path. The entire wedge assembly is mounted on a moveable carriage within a stainless steel or aluminum frame. The frame is lowered by a guide line to the seafloor mechanically from a surface vessel, and the tension on the wire keeps the prism in its “up” position. When the camera frame comes to rest on the sediment surface, the guide line goes slack (see Figure 3-12), and the camera prism descends into the sediment at a slow, controlled rate by the dampening action of a hydraulic piston to minimize disturbance at the sediment-water interface. On its descent, the prism trips a trigger that activates a time-delay circuit to allow the camera to reach maximum penetration into the seafloor before the picture is taken. Alternatively, the camera can be operated manually to take a series of images as the prism penetrates the sediment. The resulting images give the viewer the same perspective as looking through the side of an aquarium half-filled with sediment. The strobe can generally recharge in a matter of seconds.

Using SPI, the thickness of different sediment deposits can be determined by measuring the linear distance between the material types (e.g., natural deposits and a cap layer) based on the point of contact between the two layers and a textural change in sediment composition or a change in color that should be clearly visible. Also, sediment grain size can be visually estimated from the SPI photographs by comparing to a grain size reference chart at the same scale. Such a reference chart is generally prepared by photographing a series of sediments of known and varying size classes through the

SPI camera prior to a true sediment survey. Similarly, sediment color can be determined through a comparison to a detailed reference color chart, generally available from the manufacturer of the camera used.

The SPI prism penetration depth is determined by measuring the longest and shortest linear distance between the sediment-water interface and the bottom of the film frame. Software can be used to automatically average these maximum and minimum values to determine the average penetration depth. If needed, weights can be added to the SPI camera frame to enhance penetration.

3.2.3.6 Gas Flux Analysis. Submerged gas flux chambers are designed so that biogenic gas samples from within the chambers can be sampled while the chambers are underwater. Gas flux chambers generally consist of a modified steel 55-gallon drum with approximately one-third of the bottom cut away. The lid of the drum is modified to consist of a detachable steel “dome-like” top. Each chamber lid is equipped with a stainless steel, valved female, quick-connect fitting that is used to obtain gas samples. The side of the chamber can be outfitted with a stainless steel “T” that can be left open to relieve overpressure during gas production and capture within the chamber.

The cut bottom edge of the 55-gallon drum is driven into the sediment by a dive team. The chambers can be pushed through a capping layer and into the native sediment formation or keyed into a capping layer. Anchoring points are usually welded to each side of the chamber and are used to secure cinder blocks or other objects for anchoring the chambers on the sediment surface. Figure 3-13 shows a schematic diagram of a submerged gas flux chamber that would commonly be deployed for sediment investigation.

Gas samples are obtained from a gas flux chamber using a dive team. Samples are usually collected using a gastight syringe equipped with a valved stainless steel male quick-connect fitting on an umbilical cord. The syringe is attached to the valved female, quick-connect fitting on the top of the “dome” lid of the chamber via the umbilical.

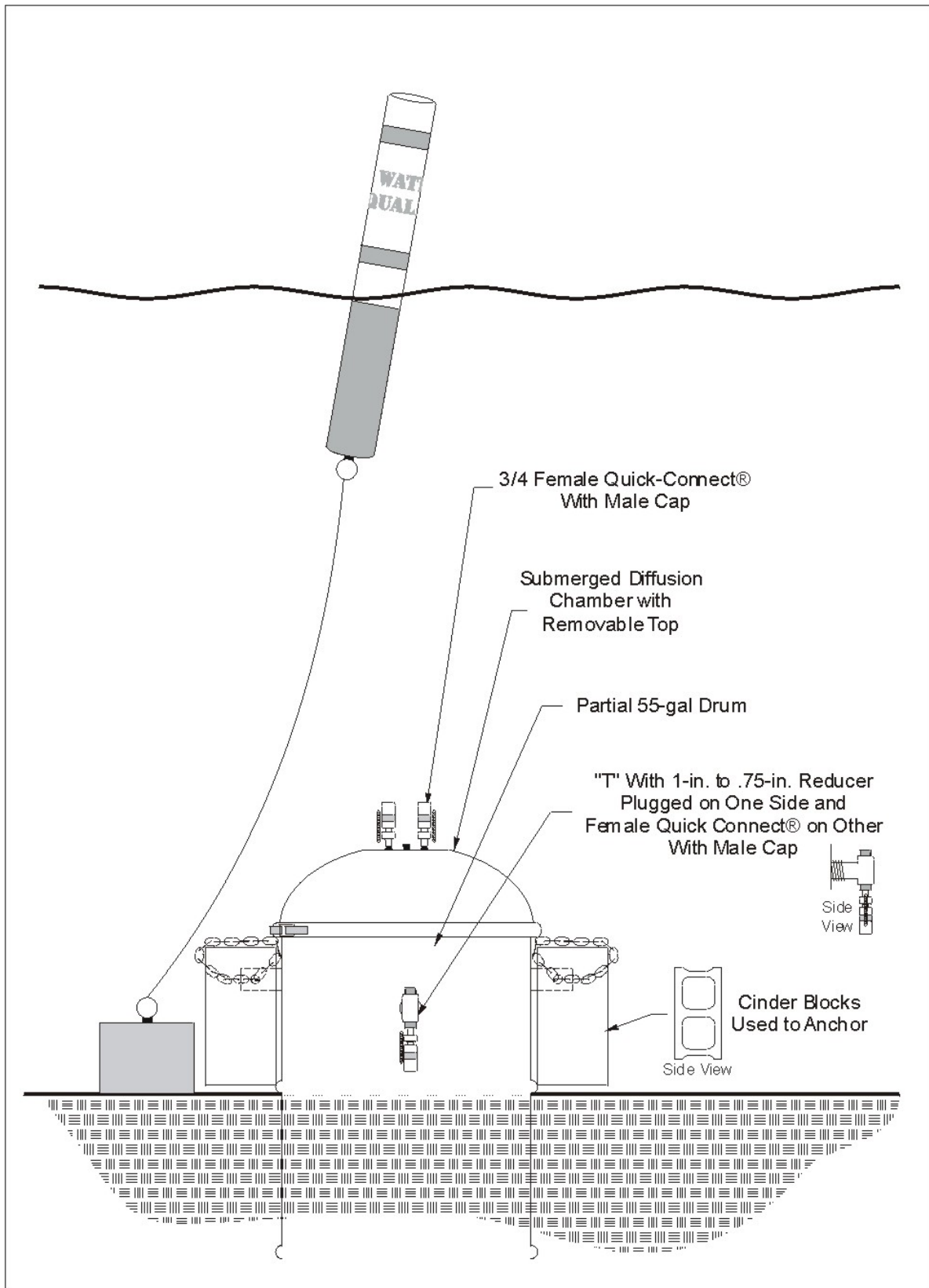

Figure 3-13. Schematic of Typical Submerged Gas Flux Chamber

Gas that has collected in the chamber through ebullition is pulled into the syringe and brought to the surface through the syringe where it is then expelled into an appropriate sample container (generally a Tedlar bag). This procedure is repeated until all gas has been removed from the gas flux chamber and water is seen to fill the syringe. Samples can be sent to a laboratory for analysis of vapor-phase characteristics or constituent concentrations. Flux is determined empirically using equations that incorporate the gas volume extracted from the chamber, the volume of the chamber, and the deployment duration. Such equations are provided and described in more detail in Section 3.3.1.2.2. Deployment duration for a submerged gas flux chamber is generally one month.

3.2.3.7 Sediment Coring and Analysis of Physical Parameters. The general methods and approach used during sediment coring are described in Section 3.2.3.2. In addition to evaluating COCs, it can be important to understand some common physical properties of sediment that can influence contaminant concentrations or other sediment characteristics. Some of the most frequently evaluated sediment physical parameters are total organic carbon (TOC), particle size distribution (PSD) (also known as grain size distribution), and moisture content. TOC is important because sediment contaminants are most commonly bound in the sediment organic carbon fraction rather than directly on inorganic matrix material (e.g., sand particles). PSD is a measure that can directly correlate varying sediment layers (i.e., a fine-grained native sediment versus a coarser-grained cap layer) to other critical measures (e.g., contaminant concentrations). Moisture content is important in understanding other bulk sediment properties (e.g., shear strength).

3.2.3.8 Sediment Coring and Analysis of Hydraulic Conductivity. The general methods and approach used during sediment coring are described in Section 3.2.3.2. In addition to evaluating COCs and physical parameters, it can be important to understand common geotechnical properties, namely hydraulic conductivity (K). This parameter, which is sometimes referred to as the coefficient of

permeability, is a proportionality that describes the rate at which water is able to move through a permeable medium. Obviously, when evaluating a material that is designed to impart a high degree of impermeability and resistance to flow, it is very important to measure K. Samples of sediment (and other materials) for the evaluation of K are generally collected in clear core liners as previously described and submitted to an appropriate testing facility as intact core sections containing the sediment interval of interest.

3.2.3.9 Seepage Meter Testing. Ground-water seepage meters provide continuous measurement of aqueous flux at high resolution over an extended period of time. These devices are frequently modeled after the ultrasonic seepage meters and funnel collection systems developed at the Cornell Cooperative Extension (CCE) marine laboratory in Cedar Beach, New York.

Using seepage meters, vertical advective flux is captured by a steel collection chamber with a square cross-section that is inserted into the sediment surface, generally by a dive team (see Figure 3-14). The captured aqueous discharge is directed via a length of tubing through an ultrasonic flow tube adapted for use in submarine environments. The flow tube is angled to allow trapped gases to escape. The ultrasonic device houses two piezoelectric transducers at either end of the flow tube that continually emit ultrasonic bursts (~400 bursts per second at an appropriate frequency) from one end of the meter to the other. The piezoelectric transducers continuously measure the travel times of the ultrasonic waves as water enters the flow tube and passes through the ultrasonic beam path (see Figure 3-15). The ultrasonic signal that travels with the direction of flow has a shorter travel time than the signal traveling against the direction of flow. The directional perturbation in travel time is directly proportional to the velocity of flow in the tube, and both forward and reverse fluid flows can be measured in real time. The ultrasonic measurement device is generally connected to a battery-powered data logger that records both incremental and cumulative discharge simultaneously. For field deployment, the data logger and a back-up battery are usually

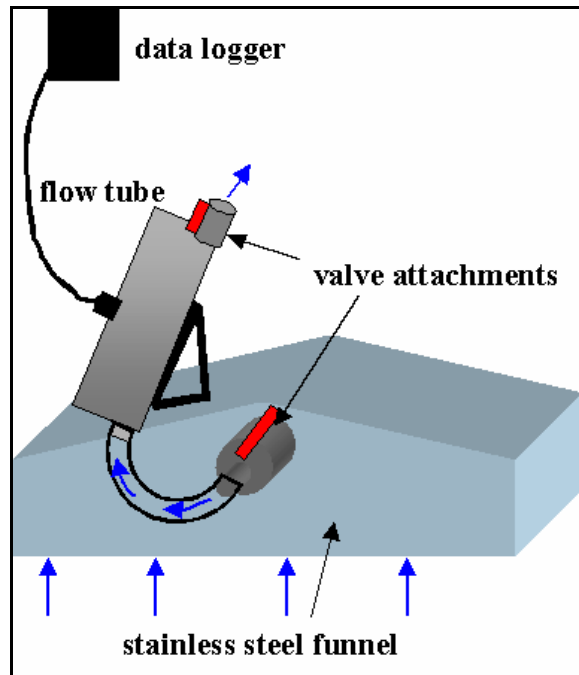

Figure 3-14. Schematic of Ultrasonic Seepage Meter (not to scale)

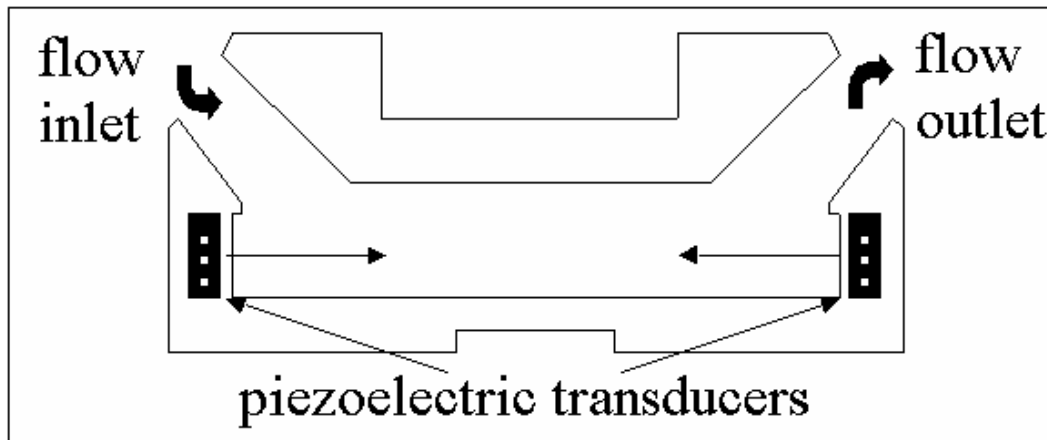

Figure 3-15. Conceptual Cross-Section of Ultrasonic Seepage Meter Flow Tube (from Paulsen et al., 2001)

housed in a floating buoy that is anchored to the sediment. The battery and back-up battery are usually selected to provide at least five days of power to minimize the possibility of equipment failure during data collection.

$$q = \left(\frac{Q}{A_t} \right) \left(\frac{A_t}{A_f} \right) = \frac{Q}{A_f} \quad (3-2)$$

The ultrasonic seepage meter records specific discharge (q) in cm/s. The directional specific discharge through the capture area at the sediment-water interface is calculated as follows:

Where Q = discharge (cm³/s);
 A_t = area of flow tube (cm²); and
 A_f = area of the funnel (cm²)

The discharge (Q) is calculated from the flow velocity through the discharge tube, multiplied by the inside cross-sectional area of the discharge tube. Flow velocity (v), in turn, is determined from the ultrasonic pulse velocity. Travel time for the upstream propagation of sound waves against the flow direction is prolonged relative to that for downstream propagation. The upstream and downstream travel times are given, respectively, by:

$$T_{up} = L / (V - v) \quad (3-3)$$

and

$$T_{down} = L / (V + v) \quad (3-4)$$

Where V = sound velocity (cm/s);
T = time (s); and
L = length of flow tube (cm)

Combining these two equations to solve for v (cm/s) yields:

$$v = \frac{L}{2T_{up} T_{down}} (T_{up} - T_{down}) \quad (3-5)$$

Travel times are generally resolved to nanoseconds to impart suitable sensitivity to the velocity measurements.

Generally, a seepage meter deployment at one location lasts from two days (48 hours) to four days (96 hours). The four-day time period provides sufficient time for the meters to equilibrate and capture tidal influences over multiple diurnal cycles. However, two days may often suffice. Data are retrieved daily, reduced, and analyzed on site to assess meter performance and data adequacy over the deployment periods.

3.2.3.10 Benthic Grab Sampling and Descriptive and Statistical Benthic Assays. A key concern during sediment capping is the long-term effect on the sediment bottom as habitat for faunal (benthic) communities, and also as potential habitat for floral communities (which will depend on prevailing water levels and other site-specific characteristics and their ability to support

emergent and/or submergent vegetation). Faunal and floral developments can be evaluated via benthic assays designed to define the type and density of benthic fauna and flora over time.

To obtain samples for the evaluation of benthic faunal (and potentially floral) communities, sediment must be collected from the uppermost interval where biogenic activity is typically concentrated (i.e., generally the upper 10 cm of sediment). Samples for benthic sediment infaunal analyses are generally collected with a bottom grab sampler, such as a Van Veen or Ponar sampler, which are both spring-activated jaws designed to scoop the upper interval of sediment on contact. Collection of appropriately undisturbed sediment samples is critical and is achieved by careful attention to established deployment and recovery procedures, including controlled sampler fall rate and sediment penetration and slow sampler recovery.

After surface sediment sample collection, the grab is placed over a bucket, the jaws opened, and the sample emptied into the bucket. Filtered river water is used to gently wash the sediment through a series of fine mesh sieves to remove inorganic sediment and debris and leave behind organisms and organic material. Generally, two sieves are used, with the first having a fine mesh size and the second having a very fine mesh size. The material remaining on the sieve(s) is then placed into a sample container and a fixing agent is added to preserve the sample. Samples are submitted to a benthic laboratory and infaunal organisms are sorted and taxonomic identifications performed by qualified biologists.

After this laboratory sorting and identification step, descriptive and statistical ecological metrics can be applied to further describe the benthic assemblages in the sediment. Calculating descriptive ecological measures provides insight into the overall structure of the community. These measures typically include simple parameters such as total abundance and numbers of species per sample, and may also include measures of diversity (e.g., the Shannon Diversity Index [H] or Pielou's Evenness Index [J]). Statistical tools can then be applied to test for differences in these measures

among/between samples or sites. Statistical tests may include simple *t*-tests or analysis of variance (ANOVA) followed by an appropriate *a posteriori* test (e.g., Tukey's Honestly Significant Different [HSD] test) to identify specific differences among/between samples or sites. Correlation analyses may also be used to evaluate the association between faunal abundance and measured environmental variable (e.g., grain size, TOC). Multivariate pattern analysis may be a final step to examine patterns among complex combinations of multivariate data. Multivariate analyses consider the identities of the species in each sample and determine degree of similarity in species composition among samples. Because of this, these analyses are typically more powerful in detecting differences among samples compared to simple or correlation statistical tests which themselves involve the use of species identities. Examples of multivariate statistical tests include the Bray-Curtis or chord-normalized expected species shared (CNESS) similarity algorithms. Ordination techniques (e.g., principal component analysis, non-metric multidimensional scaling, or multiple discriminate analysis) may also be used to estimate the set of discriminate functions that best explain the separation of sites or samples resulting from the cluster analysis in terms of selected environmental variables.

3.2.3.11 Benthic Assessment through Sediment Profile Imaging. The general methods and approach used during SPI are described in Section 3.2.3.5. SPI can also be used for the evaluation of benthic community parameters and benthic recovery. Specifically, the following types of information related to benthic fauna (and flora) can be gathered using SPI:

- The biogenic disturbance of fine-grained, cohesive sediments may cause intact clumps of sediment (mud clasts) to be scattered on the sediment surface. These may appear at the sediment-water interface in SPI images. The abundance, distribution, oxidation state, and angularity of mud clasts may be used to infer recent patterns of disturbance to the sediment surface in the area.

- The depth of the apparent reduction-oxidation (redox) potential discontinuity (RPD) in the sediment column is an important estimator of benthic habitat quality. This depth is related to the supply rate of molecular oxygen by diffusion into sediment and the subsequent consumption of that oxygen within the sediment. The term *apparent* is used in describing this parameter because no actual measurement is made of the redox potential. An assumption is made that, given the complexities of iron and sulfate redox chemistry, reddish-brown sediment color tones are indications that the sediments are oxic, or at least are not intensely reducing (Diaz and Schaffner, 1988). The exact location of the RPD depth can only be determined accurately with microelectrodes. The apparent mean RPD depth can be used as an estimate of the depth of pore water exchange, usually resulting from bioturbation.
- High organic-loading levels in sediment ultimately may cause methanogenesis to occur. Methanogenesis results in the development of methane bubbles in the sediment column which are readily visible as voids in SPI images because of their irregular, circular shape and glassy texture. If present, the number and total area covered by all such voids can be measured.
- The successional stage of an infaunal community is based on the idea that organism-sediment interactions after a disturbance follow a predictable sequence of recovery (Rhoads and Germano, 1986). This continuum of change in biological communities after a disturbance has been divided arbitrarily into three stages. Stage I is the initial colonizing community (typically small, densely-populated annelid assemblages), Stage II is an intermediate step usually comprised of more types of organisms (commonly crustaceans and perhaps some insect larvae) and is the transitional stage to a mature community, and Stage III is the mature, equilibrium community (comprised of deep-dwelling, head-down deposit feeders).

- The organism-sediment index (osi), as developed by Rhoads and Germano (1986), is an integrative estimate of the general ability of the benthic habitat to support fauna. The osi is based on three parameters that can be measured using SPI, namely the mean apparent RPD depth, presence of methane gas, and the infaunal community successional stage, and an indirect estimate of near-sediment DO levels. Higher osi values are indicative of a mature benthic community in relatively undisturbed conditions. Lower osi values reflect sediments that are azoic and have high levels of methane and little or no DO.

3.2.4 AquaBlok® SITE Demonstration Specific Approach and Methods

The specific approach and methods used during the AquaBlok® demonstration are summarized below. For simplicity, the summary follows the same general structure as Section 3.2.2, which briefly summarized the four field investigation events implemented during the demonstration. As appropriate, specific QA/QC procedures followed during the execution of the field events are also summarized.

3.2.4.1 One-Month Post-Capping Field Event. The one-month post-capping field event was conducted in May 2004. The specific monitoring tools used during this event consisted of bathymetric and sub-bottom profiling, side-scan sonar surveying, SPI, and seepage meter testing. Specific one-month post-capping field event information for these individual monitoring tools is described below.

3.2.4.1.1 One-Month Post-Capping Field Event Bathymetry and Sub-Bottom Profiling. On May 12, 2004, an initial integrated bathymetric and sub-bottom profiling survey was completed in the demonstration area. For simplicity and to maximize efficiency relative to other investigators' activities, all of the capping cells (i.e., AquaBlok®, sand, apatite, and coke breeze) and the uncapped reference cell were surveyed simultaneously using these tools rather than surveying only the cells of interest for the SITE demonstration program (i.e., AquaBlok®,

sand, and control). The surveys were conducted from a survey vessel owned by Ocean Surveys, Inc. (OSI) of Old Saybrook, Connecticut and operated by qualified oceanographic geophysicists from OSI, under the direct oversight of Battelle.

Prior to conducting the survey, a series of survey lines were established in the demonstration area, running parallel to the river bank in a generally east-west orientation. To provide adequate coverage of the study area, 29 total survey lines were established at a nominal spacing of 10 ft. In addition, prior to the survey, a tide board and gauge were installed along the bulkhead of the Washington Navy Yard property immediately north of the demonstration area to provide data on tidal level fluctuations in the river throughout the course of the survey.

The bathymetric survey was conducted by towing a dual-frequency, high-resolution depth sounder beside the survey vessel. The sub-bottom profiling was accomplished simultaneously using a high-resolution, full-spectrum FM "chirp" profiler similarly towed beside the survey vehicle. Data generated using the depth sounder and "chirp" profiler were continuously uploaded by an onboard computer. Accurate positional control was maintained by securing a differential global positioning system (dGPS) antenna to the cabin of the survey vessel immediately above the outboard equipment boom holding the depth sounder and the "chirp" profiler.

QC procedures for the bathymetric survey included calibrating the depth sounder against a metal object placed at a controlled depth beneath the transducer. Sub-bottom profiling QC included varying several equipment settings and the overall signal transmission frequency to resolve ideal survey parameters. To provide additional data QC, several survey tie-lines were completed running perpendicular to the shoreline and the pre-determined 29 survey transects, ensuring the overlap of several data points to verify positional and data accuracy.

Additional details relating to the general principles of bathymetric and sub-bottom surveying can be found in Section 3.2.3.3, and details specifically

related to the one-month post-capping bathymetric and sub-bottom profiling survey are included in Appendix B-1.

3.2.4.1.2 One-month Post-Capping Field Event Side-Scan Sonar Surveying.

On May 11, 2004, an initial side-scan sonar survey was completed in the demonstration area. For simplicity and as with the one-month post-capping bathymetry and sub-bottom profiling, all of the capping cells (i.e., AquaBlok[®], sand, apatite, and coke breeze) and the uncapped reference cell were surveyed simultaneously using side-scan sonar rather than surveying only the cells of interest for the SITE demonstration program (i.e., AquaBlok[®], sand, and control). The survey was conducted from the same survey vessel owned and operated by qualified oceanographic geophysicists from OSI as described in Section 3.2.4.1.1, again under the direct supervision of Battelle.

The side-scan sonar survey was completed along 10 of the 29 survey lines established in the demonstration area using a high-resolution side-scan sonar surveying system. Data generated using the side-scan sonar were continuously uploaded by an onboard computer. Accurate positional control was maintained by securing a dGPS antenna to the cabin of the survey vessel immediately above the outboard equipment boom holding the side-scan sonar towfish.

QC during the side-scan sonar activity included ensuring that all equipment was in working order and attempting to maintain a controlled and constant speed in the survey boat. In addition, several survey tie-lines were completed running perpendicular to the shoreline and the pre-determined 29 survey transects, ensuring the overlap of several data points to verify positional and data accuracy.

Additional details relating to the general principles of side-scan sonar surveying can be found in Section 3.2.3.4, and details relating to the one-month post-capping side-scan sonar survey are included in Appendix B-1.

3.2.4.1.3 One-Month Post-Capping Field Event Sediment Profile Imaging.

Between May 13 and 14, 2004, a thorough initial SPI investigation was completed in the demonstration area. For simplicity and to maximize efficiencies relative to other investigators' activities, SPI work was conducted throughout the demonstration area (i.e., in all capping cells and the control cell) rather than only in the AquaBlok[®], sand, and control cells.

During the SPI activities, both a high-resolution still SPI camera and a video SPI camera were used. Both were deployed from the deck of a survey vessel owned and operated by OSI with OSI personnel assisting in camera deployment and retrieval. RJ Diaz & Daughters (RJ Diaz) of Ware Neck, Virginia, provided the cameras and was responsible for operation of the cameras and related mechanical/electronic equipment. Battelle provided direct oversight of the SPI activities.

Prior to implementing the SPI work, a series of monitoring stations were determined to provide comprehensive information for each capping cell and the control cell. A total of nine individual locations were selected for each cell to be targeted with the video SPI camera, and three locations were selected to be targeted by the high-resolution still SPI camera. At each location, the survey vessel was piloted until stationed over the monitoring location of interest using a dGPS system and OSI's vessel navigation software, and then the camera was deployed while the vessel drifted at idle. The camera was deployed by dropping it slowly while attached to a rope connected to a winch. Once the frame of the camera contacted the sediment surface, the rope was manually moved up and down to further facilitate penetration until refusal was encountered.

The cameras (both high-resolution still and video) were mounted to a steel frame ballasted with lead weight to improve penetration and containing a piston arm to dampen the camera's travel (see Section 3.2.3.5 for a general description of SPI camera construction and operation). The video SPI survey was conducted first, and then the camera housing was changed out for the high-

resolution still camera survey. In addition to the monitoring stations in the capping and control cells, a single station was selected in the Anacostia River main channel outside the study area to provide additional reference information.

While using the video SPI camera, RJ Diaz remotely initiated a digital recording device upon contact of the camera with the sediment surface. The digital recording device was then turned off by RJ Diaz at the point of refusal. For the high-resolution still SPI camera, RJ Diaz triggered individual digital exposures during the camera's penetration into the sediment, also remotely.

After completing the survey, all SPI images were evaluated directly by RJ Diaz to determine specific characteristics related to the physical and ecological nature of the sediments. For standard SPI images, the least disturbed image, usually the last in the series for each cell, was analyzed digitally using Adobe PhotoShop®. Videotape recorded from the video SPI images was digitized and a sequence of still frames was then extracted with Final Cut Pro®. The still frame sequences so extracted were then stitched together using Adobe PhotoShop®. The steps in the computer analysis of each image were standardized, and all images were histogram equalized to increase contrast. All processed sediment profile images, both standard SPI and video SPI, were analyzed visually for specific physical features of interest, as follows:

Prism Penetration - This parameter provided a geotechnical estimate of sediment compaction, with the SPI camera prism acting essentially as a dead weight penetrometer. Greater prism penetration was generally associated with softer, finer-grained sediment presumably with higher water content. Penetration was measured as the distance the sediment was observed to advance over the camera faceplate.

Sediment Grain Size - The sediment type observed in various intervals in each SPI image was defined on the basis of its major modal grain size category following the Wentworth classification system. Relative grain size was determined by comparing SPI images with a set

of reference images for which mean grain size had been determined in the laboratory.

Sediment Layering - sediment layering was assessed by evaluating both color and grain size. Sediment color in various layers was characterized by intensity relative to adjoining layers by using qualitative descriptors (i.e., lighter or darker). The identification of sediment layering on the basis of grain size relied on modal grain size following the Wentworth classification system, as with the determination of sediment grain size described above. Where sediment layering was observed, the average thickness of layers was described on the basis of both measures (i.e., color and grain size).

Surface Features - Each SPI image was evaluated for the presence of distinct surface features, including a variety of purely physical (such as bedforms or floc layers) and biogenic physical features (such as biogenic mounds or tubes). Surface features were compiled by type and frequency of occurrence.

Subsurface Features - Each SPI image was evaluated for the presence of distinct subsurface features, including a variety of features that provide evidence about physical processes (such as burrows, water filled voids, gas voids, or sediment layering). Subsurface features were compiled by type and frequency of occurrence.

RJ Diaz also evaluated the processed sediment images for characteristics representative of ecological parameters, including the presence of gas voids, organism burrows, specific organisms, and osi (see Section 3.2.3.11).

QC procedures implemented during the SPI program included recording detailed information on location and frame exposure related to individual camera drops, periodically checking the color contrast of the cameras against color standards, using as close to the same drop rate and manual line-pulling approach on each camera drop as possible, and approaching each deployment location at as close to the same boat speed as possible.

Additional detail related to the one-month post-capping SPI survey is included in Appendix C.

3.2.4.1.4 One-Month Post-Capping Field Event Seepage Meter Testing.

Between May 17 and 22, 2004, an initial seepage meter investigation was implemented in the demonstration area. Because no other investigators utilized seepage meter data, this activity was implemented only for the AquaBlok[®], sand, and control cells.

In each cell, two ultrasonic seepage meters were deployed and retrieved by divers from Matrix Environmental and Geotechnical Services (Matrix) of East Hanover, New Jersey. The meters were constructed as described in Section 3.2.3.9, and consisted of an angled funnel with a square cross-sectional area of 0.209 m² attached by a 44 cm length of Tygon tubing to the flow tube. Meters were deployed by removing some amount of surface sediment material (approximately 2 in) and then gently pushing them into the bottom sediments until forming an appropriate seal, and were weighted down with ballast. Each meter was then left in place for approximately three to four days. Data were continuously downloaded by floating data loggers attached to each meter, and periodically uploaded by Matrix (see Section 3.2.3.9 for a general description of the principles of ultrasonic seepage meter testing). The loggers were capable of five hours of continuous operation, but were connected to backup batteries with a 120 hour lifespan. Battelle provided field oversight during the seepage meter testing event. One meter in the control cell was relocated during its deployment based on readings apparently heavily impacted by gas ebullition (i.e., those data demonstrated a highly erratic pattern consistent with the capture of significant amounts of gas in the flow tube).

During the seepage meter testing, surface water temperature and pressure were measured continuously at one meter location, and groundwater elevation, temperature, and conductivity were measured continuously in two monitoring wells located upland on the north side of the river.

QC during the seepage meter testing activity included ensuring that all meters were properly calibrated in the laboratory prior to deployment. In addition, two seepage meters were deployed in each cell during the demonstration to ensure data usability. Surface water and groundwater temperature data were collected to facilitate data corrections for temperature effects, and groundwater and surface water elevation data were collected to facilitate resolution of diurnal tidal cycle impacts on calculated seepage rates.

Additional detail relating to the one-month post-capping seepage meter survey is included in Appendix D-1.

3.2.4.2 Six-Month Post-Capping Field Event.

The six-month post-capping field event was conducted between September and October 2004. The specific monitoring tools used during this event consisted of bathymetric and sub-bottom profiling, SPI, seepage meter testing, Sedflume analysis, and sediment coring for the analysis of COCs and physical parameters. Specific six-month post-capping field event information for these individual monitoring tools is described below.

3.2.4.2.1 Six-Month Post-Capping Field Event Bathymetry and Sub-bottom Profiling.

Between September 14 and 15, 2004, a second integrated bathymetric and sub-bottom profiling survey was completed in the demonstration area. The six-month post-capping bathymetric and sub-bottom profiling survey was completed by OSI under the direct supervision of Battelle. All methods and procedures followed, including QA/QC, were generally identical to the one-month post-capping survey described in Section 3.2.4.1.1. To ensure the comparability of data between the six-month event and the one-month event, the identical survey transects were used during both events.

Additional detail relating to the general principles of bathymetric and sub-bottom surveying can be found in Section 3.2.3.3, and details specifically related to the six-month post-capping bathymetric and sub-bottom profiling survey are included in Appendix B-2.

3.2.4.2.2 Six-Month Post-Capping Field Event Sediment Profile Imaging.

On September 16, 2004, a second thorough SPI investigation was completed in the demonstration area. The six-month post-capping SPI survey was completed by RJ Diaz (with vessel support provided by OSI) under direct supervision of Battelle. All methods and procedures followed, including QA/QC, were generally identical to the one-month post-capping survey described in Section 3.2.4.1.3. To facilitate direct comparison between SPI data from the six-month post-capping event and SPI data from the one-month post-capping event, an effort was made to drop the camera during the six-month event relatively near the equivalent locations from the one-month event while not being closer than approximately 5 to 8 ft of the previous locations. During the six-month survey, two Anacostia River channel locations were targeted for both high-resolution and video SPI camera evaluation as opposed to the one channel reference location evaluated during the one-month survey.

Additional detail relating to the general principles of SPI surveying can be found in Section 3.2.3.5, and details specifically related to the six-month post-capping SPI survey are included in Appendix C.

3.2.4.2.3 Six-Month Post-Capping Field Event Seepage Meter Testing.

Between September 27 and October 7, 2004, a second seepage meter investigation was implemented in the demonstration area. Because other investigators utilized seepage meters during the six-month post-capping event and to maximize investigation efficiency, this activity was implemented in all capping cells and the control cell rather than only in the AquaBlok[®], sand, and control cells.

In the AquaBlok[®], sand, and control cells, two ultrasonic seepage meters each were deployed and retrieved by divers from Matrix. All methods and procedures followed, including QA/QC, were generally identical to the one-month post-capping seepage meter testing described in Section 3.2.4.1.4. Meters were deployed for approximately four to nine days, but deployment locations were not specifically near the

deployment locations from the one-month post-capping evaluation. One meter in the control cell and one meter in the AquaBlok[®] cell were relocated during deployment. The control cell meter was relocated based on readings apparently heavily impacted by gas ebullition (i.e., those data demonstrated a highly erratic pattern consistent with the capture of significant amounts of gas in the flow tube), while the AquaBlok[®] meter was relocated because it was determined that the meter had inadvertently been deployed in the portion of the cell that was not sufficiently capped during initial construction (see Section 3.1.1 and Figure 3-4).

During the six-month post-capping seepage meter testing, surface water temperature and pressure were measured continuously at one reference location established at the ECC dock, and, as with the one-month post-capping event, groundwater elevation, temperature, and conductivity were measured continuously in two monitoring wells located upland on the north side of the river.

Additional detail relating to the six-month post-capping seepage meter survey is included in Appendix D-2.

3.2.4.2.4 Six-Month Post-Capping Field Event Sedflume Coring and Analysis.

Between September 17 and 23, 2004, an initial Sedflume evaluation was conducted in the demonstration area. The evaluation was completed for the AquaBlok[®], sand, and control cells by Sea Engineering, Inc. (SEI) of Santa Cruz, California, under the direct oversight of Battelle.

During the Sedflume evaluation, 12 individual box cores were collected from the demonstration area, four each from the AquaBlok[®], sand, and control cells. One core was collected from each of four quadrants (i.e., NW, NE, SE, and SW) in each individual cell by drawing imaginary bisecting lines both north-south and east-west and so defining four unique cell areas. The cores were collected as acrylic box cores measuring 10 cm by 15 cm by approximately 1 m in length. The cores were collected manually and it was ensured that the appropriate interval of interest

(i.e., the full thickness of the capping material of interest) was captured in each respective core. At least 30 cm and no more than 100 cm of vertical core material was collected at each core location. A special valve at the top of the core section ensured that the force of suction from the native (or capped) material would not prevent the extraction of a usable core section.

Cores were evaluated immediately in a mobile Sedflume laboratory provided by SEI and stationed at the GSA property north of the investigation area. The mobile laboratory was an approximately 24-ft enclosed box truck equipped with a 325-gal water tank and a Sedflume apparatus. The apparatus and operation of the apparatus were consistent with the description provided in Section 3.2.3.1. The Sedflume apparatus used during the six-month post-capping event specifically consisted of a 5-cm, round water inlet pipe and a flow converter to transform flow from this pipe into a rectangular flow consistent with the 2 cm by 10 cm and 120 cm long testing duct.

To derive critical shear resistance information from the Sedflume, it was operated in a manner consistent with the description in Section 3.2.3.1. For each core, a series of shear stresses were applied to the core in the test section of the Sedflume, and time and erosion were recorded until at least 1 to 2 mm but not more than 2 cm were eroded. Initial shear stresses were low and were gradually increased until a maximum stress was run for each particular test. Each subsequent shear stress was generally twice the previous.

To allow for correlation between shear stress and important physical characteristics, interval samples from the cores were periodically analyzed for PSD and water content in the mobile laboratory. These samples were collected from the top of the core after each erosion cycle. Water content was determined through bulk density analysis according to American Society of Testing and Materials (ASTM) method D-2216. PSD was determined through laser dispersion.

Independent flow field measurements to characterize the hydrologic profile of the

Anacostia River were not included as part of the Sedflume approach. Such measurements would likely have included the use of an acoustic Doppler current profiler (ADCP) to calculate specific in-river velocities and sediment transport characteristics. The reason for not including the ADCP is that AquaBlok[®] cap failure due to high flow rates is unexpected due to the relatively sluggish flow of the Anacostia River (see Section 3.1) and the Sedflume procedures themselves included manipulating laboratory flows to levels higher than and uncharacteristic of the Anacostia River. Thus, ADCP measurements would have provided little information regarding the potential for cap failure that was not gleaned from the Sedflume laboratory protocol.

QC procedures implemented during the Sedflume program included recording detailed information on location related to individual cores, ensuring the working order and maintenance of all Sedflume components and equipment, adhering to appropriate laboratory methods and procedures, and collecting multiple cores from each cell for adequate data coverage. All reusable materials and supplies were decontaminated prior to reuse.

Additional detail relating to the six-month post-capping Sedflume study is included in Appendix E-1.

3.2.4.2.5 Six-Month Post-Capping Field Event Sediment Coring and Analysis of Contaminants of Concern and Physical Parameters. Between September 20 and 25, 2004, an initial sediment coring investigation was completed in the demonstration area. Multiple sediment cores were collected using vibracoring techniques from a coring vessel owned and operated by Athena Technologies, Inc. (Athena) of Columbia, South Carolina. Coring was overseen by Battelle and sediment cores were evaluated and processed by Battelle personnel.

During the six-month post-capping field event, two individual cores were collected from each of the four unique quadrants in the AquaBlok[®], sand, and control cells, for a total of eight cores per cell and 24 total cores overall. In addition, to facilitate evaluations by other investigators,

additional cores were collected simultaneously in these cells as well as the other capping cells (i.e., apatite and coke breeze). Cores were collected from the deck of an aluminum coring vessel equipped with a coring derrick and a sampling moonpool. A vibratory head was hoisted by the coring derrick and connected to a core barrel containing a butyrate liner. The butyrate liner used was approximately 3-in in diameter. The barrel was lowered to the sediment surface and pushed into the sediment under direct pressure or by adding vibration until an adequate depth had been achieved to visually assess sediment lithology and collect necessary laboratory samples. The core barrel was then extracted using a winch on the coring derrick. Upon core retrieval, the butyrate liner was extracted, cut to length and as not to disturb the core, wiped clean, capped on both ends using plastic caps and electrical tape, labeled, stored upright, and transported to Battelle for processing and sample extraction. Accurate positional control was maintained using a GPS, and the coring vessel was held in place over each coring station using spuds lowered gently through the water and into the bottom sediments.

Battelle established a core processing facility at the GSA property located north of the investigation area. The core processing facility consisted of an approximately 16-ft enclosed truck equipped with a collapsible processing table and all expendable materials and supplies needed.

For each quadrant of each cell, the two replicate cores were evaluated visually through the sidewall of the butyrate liner to determine sediment lithology and determine the thickness of various sediment layers and the location of lithologic interfaces. After determining this lithologic information, Battelle personnel dissected the cores to generate samples for laboratory analysis of COCs and physical parameters according to a previously established sampling plan. According to this previously established sampling plan, an attempt was made to collect the following sample intervals depending on the actual thickness of various lithologic intervals:

- AquaBlok[®] cell: collect three individual samples from the overlying sand layer, one sample from the interface of the overlying sand layer and the AquaBlok[®] capping layer, three individual samples within the AquaBlok[®] capping layer, one sample from the interface of AquaBlok[®] and native sediments, and one sample from the upper horizon of the native sediment unit, for a total of nine unique samples per core.
- Sand cell: collect four individual samples from the sand capping layer, one sample from the interface of the sand capping layer and the underlying native sediment, and one sample from the upper horizon of the native sediment unit, for a total of six individual samples per core.
- Control cell: collect three individual samples from the upper horizon of the native sediment unit, for a total of three individual samples per core.

Each sample interval was intended to be a 3 cm vertical segment of material. A stainless steel hacksaw was used to cut the cores at intervals determined to correspond to the desired sample intervals described above. For each pair of replicate cores collected from each cell quadrant, material from each corresponding sampling interval was composited in a stainless steel mixing bowl and mixed until of uniform color and consistency. Subsequently, composited material was placed in laboratory-provided sample glassware for analysis of COCs and physical parameters. Accordingly, actual data were only generated for one core per quadrant per cell. All samples were properly labeled and stored on ice in coolers under appropriate chain of custody until delivered to the analytical laboratories.

Each sampling interval from each core was analyzed for six individual metals (Cd, Cr, Cu, Pb, Hg, and silver [Ag]), PCB congeners, PAHs, PSD, and TOC. Metals analyses were conducted by Battelle's Sequim Marine Laboratory (Sequim) in Sequim, Washington; PCB and PAH analyses were conducted by Battelle's Duxbury Operations (BDO) of Duxbury, Massachusetts, and PSD and TOC analyses were conducted by Applied Marine Sciences (AMS) of League City, Texas. Metals,

PCB, and PAH analyses were conducted using standard EPA methods, specifically Method 6010B for all metals other than Hg, Method 7471A for Hg, modified Method 8270 for PCBs, and Method 8270/8015 for PAHs. TOC and PSD analyses were conducted using appropriate EPA or ASTM methods, specifically EPA Method 9060M or ASTM Method D2974-00 for TOC and ASTM Method D422 for PSD.

QC procedures implemented during the sediment coring program included recording detailed information on location related to individual cores, ensuring the working order and maintenance of all vibracoring components and equipment, adhering to appropriate laboratory methods and procedures, and collecting multiple cores from each cell for adequate data coverage. All reusable materials and supplies were properly decontaminated prior to reuse.

3.2.4.3 18-Month Post-Capping Field Event. The 18-month post-capping field event was conducted between August and September 2005. The specific monitoring tools used during this event consisted of bathymetric and sub-bottom profiling, side-scan sonar surveying, SPI, seepage meter testing, sediment coring for the analysis of COCs, physical parameters, and hydraulic conductivity, and gas flux analysis. Specific 18-month post-capping field event information for these individual monitoring tools is described below.

3.2.4.3.1 18-Month Post-Capping Field Event Bathymetry and Sub-bottom Profiling. On September 15, 2005, a third integrated bathymetric and sub-bottom profiling survey was completed in the demonstration area. The 18-month post-capping bathymetric and sub-bottom profiling survey was completed by OSI under the direct supervision of Battelle. All methods and procedures followed, including QA/QC, were generally identical to the one-month and six-month post-capping surveys described in Sections 3.2.4.1.1 and 3.2.4.2.1, respectively. To ensure the comparability of data between the 18-month event and the one-month and six-month events, the identical survey transects were used.

Additional detail relating to the general principles of bathymetric and sub-bottom surveying can be found in Section 3.2.3.3, and details specifically related to the 18-month post-capping bathymetric and sub-bottom profiling survey are included in Appendix B-3.

3.2.4.3.2 18-Month Post-Capping Field Event Side-Scan Sonar Surveying. On September 14, 2005, a second side-scan sonar survey was completed in the demonstration area. The 18-month post-capping side-scan sonar survey was completed by OSI under the direct supervision of Battelle. All methods and procedures followed, including QA/QC, were generally identical to the one-month post-capping survey described in Section 3.2.4.1.2. To ensure the comparability of data between the 18-month event and the one-month events, the identical side-scan survey transects were used.

Additional detail relating to the general principles of side-scan sonar surveying can be found in Section 3.2.3.4, and details specifically related to the 18-month post-capping side-scan sonar survey are included in Appendix B-3.

3.2.4.3.3 18-Month Post-Capping Field Event Sediment Profile Imaging. On September 16, 2005, a third thorough SPI investigation was completed in the demonstration area. The 18-month post-capping SPI survey was completed by RJ Diaz (with vessel support provided by OSI) under the direct supervision of Battelle. All methods and procedures followed, including QA/QC, were generally identical to the one-month and six-month post-capping surveys described in Section 3.2.4.1.3 and Section 3.2.4.2.2, respectively. To facilitate direct comparison between SPI data from the 18-month post-capping event and SPI data from the one-month and six-month post-capping events, an effort was made to drop the camera during the 18-month event relatively near the equivalent locations from the previous events while not being closer than approximately five to eight feet of the previous locations. During the 18-month survey, three Anacostia River channel locations were targeted with the high-resolution SPI camera and four channel locations were targeted with the video SPI camera.

Additional detail relating to the general principles of SPI surveying can be found in Section 3.2.3.5, and details specifically related to the 18-month post-capping SPI survey are included in Appendix C.

3.2.4.3.4 18-Month Post-Capping Field Event Seepage Meter Testing. Between September 19 and 23, 2005, a third seepage meter investigation was implemented in the demonstration area. Because other investigators did not utilize seepage meters during the 18-month post-capping event, this activity was implemented only in the AquaBlok[®], sand, and control cells.

In the AquaBlok[®], sand, and control cells, two ultrasonic seepage meters each were deployed and retrieved by divers from Matrix. All methods and procedures followed, including QA/QC, were generally identical to the one-month and six-month post-capping seepage meter testing described in Sections 3.2.4.1.4 and 3.2.4.2.3, respectively. Meters were deployed for approximately four to six days, but deployment locations were not specifically near the deployment locations from the one-month or six-month post-capping evaluations. One meter in the AquaBlok[®] cell became air locked during deployment but was cleared and resumed measurements.

During the 18-month post-capping seepage meter testing, surface water temperature and pressure were measured continuously at one reference location established at the ECC dock, and, as with the one-month and six-month post-capping events, groundwater elevation, temperature, and conductivity were measured continuously in two monitoring wells located upland on the north side of the river.

Additional detail relating to the 18-month post-capping seepage meter survey is included in Appendix D-3.

3.2.4.3.5 18-Month Post-Capping Field Event Sediment Coring and Analysis of Contaminants of Concern, Physical Parameters, and Hydraulic Conductivity. Between September 27 and 28, 2005, a second

sediment coring investigation was completed in the demonstration area. Multiple sediment cores were collected using vibracoring techniques from a coring vessel owned and operated by Athena. Coring was overseen by Battelle and sediment cores were evaluated and processed by Battelle personnel.

During the 18-month post-capping field event, two individual cores were collected from two of the four unique quadrants in the AquaBlok[®], sand, and control cells, for a total of four cores per cell and 12 total cores overall. In addition, to facilitate evaluations by other investigators, additional cores were collected simultaneously in these cells as well as the other capping cells (i.e., apatite and coke breeze). Cores were collected according to the same procedures and standards described for the six-month post-capping coring event in Section 3.2.4.2.5. To facilitate direct comparison between coring data from the 18-month post-capping event and coring data from the six-month post-capping event, an effort was made to collect cores during the 18-month event from relatively near the equivalent locations from the six-month event while not being closer than approximately 5 to 8 ft of the previous locations or closer than approximately 8 to 10 ft of a cell's edge.

Battelle established a core processing facility at the WASA property located north of the investigation area. The core processing facility was nearly identical to that described in Section 3.2.4.2.5. For each quadrant sampled from each cell, the two replicate cores were evaluated by cutting away a lengthwise section of the butyrate liner to directly view the intact vertical sediment profile. From this, sediment lithology, thickness of various sediment layers and the location of lithologic interfaces were determined. After determining this information, Battelle personnel dissected the cores to generate samples for laboratory analysis of COCs and physical parameters according to the same previously established sampling plan described in Section 3.2.4.2.5.

Stainless steel spoons or scoops were used to remove sediment from the cores from intervals determined to correspond to the selected sample

intervals of interest. For each pair of replicate cores collected from each cell quadrant, material from each corresponding sampling interval was composited in a stainless steel mixing bowl and mixed until of uniform color and consistency. Subsequently, composited material was placed in laboratory-provided sample glassware for analysis of COCs and physical parameters. Accordingly, actual data were only generated for one core per quadrant per cell. All samples were properly labeled and stored on ice in coolers under appropriate chain of custody until delivered to the analytical laboratories.

Each sampling interval from each core was analyzed for the same constituents as described in Section 3.2.4.2.5 (i.e., Cd, Cr, Cu, Pb, Hg, Ag, PCB congeners, PAHs, PSD, and TOC). As with the six-month post-capping coring activity, metals analyses were conducted by Sequim, PCB and PAH analyses were conducted by BDO, and PSD and TOC analyses were conducted by AMS. All analyses were conducted using standard EPA or ASTM methods as described in Section 3.2.4.2.5.

In addition, during the 18-month post-capping coring activity, two cores each were collected from locations within the AquaBlok[®], sand, and control cells for evaluation of hydraulic conductivity. These cores were collected from two of the four cell quadrants for each cell in the same manner as those collected for lithologic evaluation and chemical analysis. During coring, it was ensured that these cores penetrated a sufficient vertical distance to obtain the full vertical thickness of the material of interest for each cell area (i.e., AquaBlok[®], sand, or native sediment). These cores were left intact (i.e., capped within the butyrate liner and not opened or disturbed), labeled, stored on ice, and delivered under appropriate chain of custody to AMS for the laboratory determination of hydraulic conductivity according to ASTM Method D5084-D.

QC procedures implemented during the sediment coring program included recording detailed information on location related to individual cores, ensuring the working order and maintenance of all vibracoring components and equipment, adhering to appropriate laboratory methods and

procedures, and collecting multiple cores from each cell for adequate data coverage. All reusable materials and supplies were properly decontaminated prior to reuse.

3.2.4.3.6 18-Month Post-Capping Field Event Gas Flux Analysis. Between August 24 and September 26, 2005, an initial gas flux investigation was implemented in the demonstration area. Because no other investigators utilized this monitoring tool, gas flux chambers were deployed only in the AquaBlok[®], sand, and control cells. The general principles and methods of gas flux monitoring are described in Section 3.2.3.6.

On August 25, 2005, stainless steel gas flux chambers were deployed at two locations each in the AquaBlok[®], sand, and control cells. The chambers were generally consistent with the conceptual image provided in Figure 3-13, but had only one top valve and a more conical upper chamber component.

The chambers were installed on the sediment surface by a dive team from K&M Marine, Inc. (K&M) of Lusby, Maryland, under the oversight of Battelle personnel. At each deployment location, a chamber was transported to the sediment surface by a diver, pushed into the bottom sediment until firmly seated, and anchored in place by two cinder blocks connected with chain to the chamber at welded anchor points. In general, the chambers were pushed into the bottom sediments by approximately 6 to 8 in. The locations of the chambers were determined prior to deployment. The surface vessel carrying the dive team was positioned over the predetermined locations using GPS and the diver was released to rapidly descend. At the request of the EPA, the side valves on each chamber were left in a closed position.

On September 26, 2005, following an approximately one-month deployment period, Battelle personnel collected gas samples from the submerged gas flux chambers. At each monitoring location, a diver from K&M descended to the chamber and attached a male quick connect fitting to the female quick connect fitting on the chamber's top. The male quick connect

fitting was in turn connected to a length of polyethylene tubing extending to a surface support vessel. At the surface, the tubing was connected to a 1-liter (L) airtight, graduated, acrylic syringe. The plunger of the syringe was retracted, and all gas that had collected in the submerged chamber was extracted and its volume determined.

Upon extraction, gas samples were injected into Tedlar bags which were labeled, stored, and shipped under appropriate chain of custody protocol to AirToxics, Ltd. (AirToxics) of Folsom, California. Gas samples were then analyzed for total non-methane organic carbon (TNMOC), common gases (i.e., carbon dioxide [CO₂], methane [CH₄], nitrogen [N₂], and oxygen [O₂]), and reduced sulfur compounds using standard EPA or ASTM methods. Specifically, TNMOC was evaluated using EPA Method 25C, common gases were evaluated using EPA Method 3C, and reduced sulfur compounds were evaluated using ASTM Method D5504.

At the conclusion of the 18-month post-capping flux chamber sampling event, the chambers were left in place to be used for the subsequent 30-month post-capping flux chamber sampling event (see Section 3.2.4.4.7). However, it was subsequently determined that there was a reasonable risk that the chambers could be lost or significantly fouled. Accordingly, on April 14, 2006, the flux chambers were removed by a dive team from K&M under the supervision of Battelle personnel and the chambers were stored pending their use during the 30-month post-capping field events.

QC procedures implemented during the gas flux sampling program included recording detailed information on locations of individual chambers, ensuring the working order and maintenance of all diving and chamber-related components and equipment, adhering to appropriate laboratory methods and procedures, and collecting adequate samples from each cell for suitable data coverage. Other QC procedures related to the evaluation of gas flux chamber data are described in Section 3.2.4.5 below.

3.2.4.4 30-Month Post-Capping Field Event. The 30-month post-capping field event was conducted between August and October 2006. The specific monitoring tools used during this event consisted of bathymetric and sub-bottom profiling, side-scan sonar surveying, SPI, seepage meter testing, Sedflume analysis, sediment coring for the analysis of COCs, physical parameters, and hydraulic conductivity, gas flux analysis, and benthic grab sampling and descriptive and statistical benthic assays. Specific 30-month post-capping field event information for these individual monitoring tools is described below.

3.2.4.4.1 30-Month Post-Capping Field Event Bathymetry and Sub-Bottom Profiling. On September 19, 2006, a fourth integrated bathymetric and sub-bottom profiling survey was completed in the demonstration area. The 30-month post-capping bathymetric and sub-bottom profiling survey was completed by OSI under the direct supervision of Battelle. All methods and procedures followed, including QA/QC, were generally identical to the one-month, six-month, and 18-month post-capping surveys described in Sections 3.2.4.1.1, 3.2.4.2.1, and 3.2.4.3.1, respectively. To ensure the comparability of data between the 30-month event and the previous events, the identical survey transects were used during the 30-month post-capping survey as were used during the previous surveys.

Additional detail relating to the general principles of bathymetric and sub-bottom surveying can be found in Section 3.2.3.3, and details specifically related to the 30-month post-capping bathymetric and sub-bottom profiling survey are included in Appendix B-4.

3.2.4.4.2 30-Month Post-Capping Field Event Side-Scan Sonar Surveying. On September 20, 2006, a third side-scan sonar survey was completed in the demonstration area. The 30-month post-capping side-scan sonar survey was completed by OSI under the direct supervision of Battelle. All methods and procedures followed, including QA/QC, were generally identical to the one-month and 18-month post-capping surveys described in Section

3.2.4.1.2 and 3.2.4.3.2, respectively. To ensure the comparability of data between the 30-month event and the one-month and 18-month events, identical side-scan survey transects were used during the 30-month post-capping survey as were used during the previous surveys.

Additional details relating to the general principles of side-scan sonar surveying can be found in Section 3.2.3.4, and details specifically related to the 30-month post-capping side-scan sonar survey are included in Appendix B-4.

3.2.4.4.3 30-Month Post-Capping Field Event Sediment Profile Imaging. Between September 20 and 21, 2006, a fourth thorough SPI investigation was completed in the demonstration area. The 30-month post-capping SPI survey was completed by RJ Diaz (with vessel support provided by OSI) under the direct supervision of Battelle. All methods and procedures followed, including QA/QC, were generally identical to the one-month, six-month, and 18-month post-capping surveys described in Sections 3.2.4.1.3, 3.2.4.2.2, and 3.2.4.3.3, respectively. To facilitate direct comparison between SPI data from the 30-month post-capping event and SPI data from the previous post-capping events, an effort was made to drop the camera during the 30-month event relatively near the equivalent locations from the previous events while not being within approximately 5 to 8 ft of the previous locations. During the 30-month survey, seven Anacostia River channel locations were targeted with the high-resolution SPI camera and one channel location was targeted with the video SPI camera for additional reference data.

Additional details relating to the general principles of SPI surveying can be found in Section 3.2.3.5, and details specifically related to the 30-month post-capping SPI survey are included in Appendix C.

3.2.4.4.4 30-Month Post-Capping Field Event Seepage Meter Testing. Between September 25 and 30, 2006, a fourth seepage meter investigation was implemented in the demonstration area. Because other investigators did not utilize seepage meters during the 30-

month post-capping event, this activity was implemented only in the AquaBlok[®], sand, and control cells.

In the AquaBlok[®], sand, and control cells, two ultrasonic seepage meters each were deployed and retrieved by divers from Matrix. All methods and procedures followed, including QA/QC, were generally identical to the one-month, six-month, and 18-month post-capping seepage meter testing described in Sections 3.2.4.1.4, 3.2.4.2.3, and 3.2.4.3.4, respectively. Meters were deployed for approximately three to four days, but deployment locations were not specifically near the deployment locations from the previous post-capping evaluations. One meter in the AquaBlok[®] cell was relocated during deployment after initial data collected suggested it might have been located in an area where the cap had been compromised by other sampling events (i.e., the data suggested there was potentially a preferential flow path at the meter location, essentially short-circuiting any potential hydraulic control).

During the 30-month post-capping seepage meter testing, surface water temperature and pressure were measured continuously at one reference location established at the ECC dock, and, as with the other post-capping events, groundwater elevation, temperature, and conductivity were measured continuously in two monitoring wells located upland on the north side of the river.

Additional details relating to the 30-month post-capping seepage meter survey are included in Appendix D-4.

3.2.4.4.5 30-Month Post-Capping Field Event Sedflume Analysis. Between October 17 and 22, 2006, a second Sedflume evaluation was conducted in the demonstration area. The evaluation was completed for the AquaBlok[®], sand, and control cells by SEI under the direct oversight of Battelle.

During the Sedflume evaluation, 12 individual box cores were collected from the demonstration area, four each from the AquaBlok[®], sand, and control cells. One core was collected from each

of four quadrants (i.e., NW, NE, SE, and SW) similar to the approach used during the six-month post-capping Sedflume study described in Section 3.2.4.2.4. The cores were collected in the same manner as the six-month survey.

Cores were evaluated immediately in a mobile Sedflume laboratory provided by SEI and stationed at the WASA property north of the investigation area. The mobile laboratory was generally identical to that described for the six-month post-capping evaluation (see Section 3.2.4.2.4). To derive critical shear resistance information from the Sedflume, it was operated in a manner consistent with the description in Section 3.2.3.1. For each core, a series of shear stresses were applied to the core in the test section of the Sedflume, and time and erosion were recorded until at least 1 to 2 mm but not more than 2 cm were eroded. Initial shear stresses were low and were gradually increased until a maximum stress was run for each particular test. Each subsequent shear stress was generally twice the previous.

To allow for correlation between shear stress and important physical characteristics, interval samples from the cores were periodically analyzed for PSD and water content in the mobile laboratory. These samples were collected from the top of the core after each erosion cycle. Water content was determined through bulk density analysis according to ASTM method D-2216. PSD was determined through laser dispersion.

Independent flow field measurements to characterize the hydrologic profile of the Anacostia River were not included as part of the Sedflume approach during the 30-month survey, consistent with the six-month survey. Such measurements would have included the use of an ADCP to calculate specific in-river velocities and sediment transport characteristics. The reason for not including the ADCP is that AquaBlok® cap failure due to high flow rates is unexpected due to the relatively sluggish flow of the Anacostia River (see Section 3.1) and the Sedflume procedures themselves included manipulating laboratory flows to levels higher than and uncharacteristic of the Anacostia River. Thus, ADCP measurements

would have provided little information regarding the potential for cap failure that was not gleaned from the Sedflume laboratory protocol.

QC procedures implemented during the Sedflume program included recording detailed information on location related to individual cores, ensuring the working order and maintenance of all Sedflume components and equipment, adhering to appropriate laboratory methods and procedures, and collecting multiple cores from each cell for adequate data coverage. All reusable materials and supplies were decontaminated prior to reuse.

Additional detail relating to the 30-month post-capping Sedflume study is included in Appendix E-2.

3.2.4.4.6 30-Month Post-Capping Field Event Sediment Coring and Analysis of Contaminants of Concern, Physical Parameters, and Hydraulic Conductivity.

Between October 17 and 19, 2006, a third sediment coring investigation was completed in the demonstration area. Multiple sediment cores were collected using vibracoring techniques from a coring vessel owned and operated by Athena. Coring was overseen by Battelle and sediment cores were evaluated and processed by Battelle personnel.

During the 30-month post-capping field event, two individual cores were collected from each of the four unique quadrants in the AquaBlok®, sand, and control cells, for a total of eight cores per cell and 24 total cores overall. In addition, to facilitate evaluations by other investigators, additional cores were collected simultaneously in these cells as well as the other capping cells (i.e., apatite and coke breeze). Cores were collected according to the same procedures and standards described for the six-month post-capping coring event in Section 3.2.4.2.5. To facilitate direct comparison between coring data from the 30-month post-capping event and coring data from the previous coring events, an effort was made to collect cores during the 30-month event from relatively near the equivalent locations from the previous events while not being closer than approximately 5 to 8 ft of the previous locations

or closer than approximately 8 to 10 ft of a cell's edge.

Battelle established a core processing facility at the WASA property located north of the investigation area. The core processing facility was nearly identical to that described in Section 3.2.4.2.5. For each quadrant sampled from each cell, the two replicate cores were evaluated in identical fashion to the 18-month post-capping coring work described in Section 3.2.4.3.5.

Stainless steel spoons or scoops were used to remove sediment from the cores from intervals determined to correspond to the selected sample intervals of interest. For each pair of replicate cores collected from each cell quadrant, material from each corresponding sampling interval was composited in a stainless steel mixing bowl and mixed until of uniform color and consistency. Subsequently, composited material was placed in laboratory-provided sample glassware for analysis of COCs and physical parameters. Accordingly, actual data were only generated for one core per quadrant per cell. All samples were properly labeled and stored on ice in coolers under appropriate chain of custody until delivered to the analytical laboratories.

Each sampling interval from each core was analyzed for the same constituents as described in Section 3.2.4.2.5 (i.e., Cd, Cr, Cu, Pb, Hg, Ag, PCB congeners, PAHs, PSD, and TOC). As with the six-month and 18-month post-capping coring activities, metals analyses were conducted by Sequim, PCB and PAH analyses were conducted by BDO, and PSD and TOC analyses were conducted by AMS. All analyses were conducted using standard EPA or ASTM methods as described in Section 3.2.4.2.5.

In addition, during the 30-month post-capping coring activity, two cores each were collected from locations within the AquaBlok[®], sand, and control cells for evaluation of hydraulic conductivity. These cores were collected from two of the four cell quadrants for each cell, and were collected in identical fashion to those collected for lithologic evaluation and chemical analysis. During coring, it was ensured that these cores penetrated a sufficient vertical

distance to obtain the full vertical thickness of the material of interest for each cell area (i.e., AquaBlok[®], sand, or native sediment). These cores were left intact (i.e., capped within the butyrate liner and not opened or disturbed), labeled, stored on ice, and delivered under appropriate chain of custody to AMS for the laboratory determination of hydraulic conductivity according to ASTM Method D5084-D. To facilitate direct comparison between hydraulic conductivity data from the 30-month post-capping event and from the 18-month coring event, an effort was made to collect hydraulic conductivity cores during the 30-month event from relatively near the equivalent locations from the previous event while not being closer than approximately 5 to 8 ft of the previous locations.

QC procedures implemented during the sediment coring program included recording detailed information on location related to individual cores, ensuring the working order and maintenance of all vibracoring components and equipment, adhering to appropriate laboratory methods and procedures, and collecting multiple cores from each cell for adequate data coverage. All reusable materials and supplies were properly decontaminated prior to reuse.

3.2.4.4.7 30-Month Post-Capping Field Event Gas Flux Analysis. Between August 14 and September 13, 2006, a second gas flux investigation was implemented in the demonstration area. Because no other investigators utilized this monitoring tool, gas flux chambers were deployed only in the AquaBlok[®], sand, and control cells. The general principles and methods of gas flux monitoring are described in Section 3.2.3.6.

On August 14, 2006, stainless steel gas flux chambers were deployed at two locations each in the AquaBlok[®], sand, and control cells. The chambers were the same chambers used during the 18-month post-capping gas flux evaluation (see Section 3.2.4.3.6).

The chambers were installed on the sediment surface by a dive team from K&M under the oversight of Battelle personnel. At each deployment location, a chamber was transported

to the sediment surface by a diver and installed in identical fashion to that described in Section 3.2.4.3.6. To facilitate direct comparison between gas flux data from the 30-month post-capping event and from the 18-month coring event, an effort was made to position the chambers during the 30-month event immediately near the equivalent locations from the previous event while not being within approximately 5 to 8 ft of the previous locations. Consistent with the 18-month post-capping deployment, the side valves on each chamber were left in a closed position.

On September 13, 2006, following an approximately one-month deployment period, Battelle personnel collected gas samples from the submerged gas flux chambers. Samples were collected in identical fashion to that described in Section 3.2.4.3.6.

Upon extraction, and as with the 18-month post-capping event, gas samples were injected into Tedlar bags which were labeled, stored, and shipped under appropriate chain of custody protocol to AirToxics. Gas samples were then analyzed for TNMOC, common gases (i.e., CO₂, CH₄, N₂, and O₂), and reduced sulfur compounds using the same standard EPA or ASTM methods used for the 18-month post-capping event.

At the conclusion of the 30-month post-capping flux chamber sampling event, the chambers were removed by the dive team from K&M.

QC procedures implemented during the gas flux sampling program included recording detailed information on location related to individual chambers, ensuring the working order and maintenance of all diving and chamber-related components and equipment, adhering to appropriate laboratory methods and procedures, and collecting adequate samples from each cell for suitable data coverage. Other QC procedures related to the evaluation of gas flux chamber data are described in Section 3.2.4.5 below.

3.2.4.4.8 30-Month Post-Capping Field Event Benthic Grab Sampling and Descriptive and Statistical Benthic Assays. Between October 17 and 19, 2007, 36

sediment grab samples (three samples from each of the four quadrants within the AquaBlok[®], sand, and control cells) were collected to evaluate benthic infaunal communities in the demonstration area.

Benthic samples for infaunal analyses were collected using a stainless steel 0.04-m² modified Van Veen grab sampler deployed from the sampling vessel owned and operated by Athena simultaneously with the 30-month post-capping sediment coring activities. The sampling platform was equipped with dGPS connected to a laptop computer running navigational software for positional control. Sample collection coordinates were stored electronically on the laptop in real-time during field operations.

The open grab was lowered to the river bottom from the sampling vessel. When the line went slack, a mechanical, counterweighted latch released the arms, allowing them to close the grab as the line was retrieved. Once the closed grab was returned to the sampling vessel, the top covers of the grab were opened and the contents inspected. If the sample was adequate in volume and quality, it was deemed acceptable. The sediment sample depth within the grab was measured to the nearest 0.1 cm and recorded for sample volume calculations. The sample was transferred to a pre-marked sample tray for storage and transport to shore. Three grab samples were collected from the bow of the sample vessel at each location (one from the port-bow corner, one from the center-bow, and one from the starboard-bow corner). After the three grab samples were collected, they were transferred to shore for processing. Once on shore, each benthic sample was rinsed with river water over nested 1.0- and 0.5-mm sieves to remove fine sediment particles. Material retained on the sieves was transferred carefully into labeled polyethylene bottles. Samples were fixed in the field by adding buffered 10 percent (%) formalin solution (3.7% formaldehyde) to each sample bottle.

Infauna was removed from the sediment grab samples and taxonomic identifications were performed by Cove Corporation (Cove) of Lusby, Maryland. The 36 individual samples were sorted

to remove at least 95% of the infaunal organisms. QC was accomplished by re-sorting a complete sample once for at least every nine samples sorted. Data from the three grab samples collected from each cell quadrant were pooled (summed) for statistical analysis. The equivalent sample size of the pooled grab samples was 0.12 m². A total of 12 pooled observations were completed for the demonstration area (i.e., three pooled grabs in four quadrants each for three cells).

The primary ecological metrics used to evaluate infaunal communities during the 30-month post-capping benthic assessment were total abundance, total species, Sander's Rarefaction (E[S_n]; modified by Hurlbert, 1971), species presence-absence (occurrence), major taxon abundance, and the most abundant species. Several other traditional ecological metrics, including *H'* (calculated using log₂), *J'*, log-series *alpha* diversity (May, 1975), and Margalef's species richness (*d*), were calculated for each sample and reported because of their general ecological interest (Ludwig and Reynolds, 1988). The software package Primer 5 for Windows (Version 5.2.9, ©2002, Primer-E, Ltd.) was used to calculate all of these metrics except Sander's rarefaction. BioDiversity Professional, Version 2 (© 1997 The Natural History Museum/ Scottish Association for Marine Science) was used to calculate the rarefaction values.

Standard descriptive statistics including the mean, median, and coefficient of variation (CV) were calculated, and boxplots generated for selected ecological parameters for each pooled sample by using Microsoft® Excel or Minitab™ software. Several ecological parameters and the abundances of selected key taxa were evaluated by using the Kruskal-Wallis test of equal median response.

Similarity analyses, using the Bray-Curtis similarity coefficient (S') as a measure of distance between stations (described in Clarke and Warwick, 2001), were also performed using Primer™. Abundance data were square-root transformed, but not standardized prior to analyses. The similarity matrix was converted to a dendrogram using the hierarchical, unweighted

pair-group mean-averaging method of clustering. Each similarity matrix was also transformed to a two-dimensional, non-metric multidimensional scaling (nMDS) plot, which expresses the Bray-Curtis similarity in two dimensions such that more similar samples are spatially close together (Clark and Warwick, 2001). Primer™ generated each plot by restarting the nMDS algorithm 30 times and selecting the lowest stress value (Clarke and Warwick, 2001). Several physical and biological parameters were then mapped onto the nMDS plots to help identify factors that might explain the similarity patterns identified by the analysis.

Finally, the potential relationships between the faunal communities in the Anacostia River and selected physical factors were evaluated by an approach similar to that conducted for the biological analyses. Primer™ was used to run a similarity analysis of a reduced set of physical parameters with normalized Euclidean distance as the similarity measure. Primer™ then generated an nMDS plot based on the resulting similarity matrix. Several physical and biological parameters were then mapped onto the nMDS plots to help identify faunal distribution that might be explained by the similarity patterns based on physical habitat characteristics.

The complete details of the sorting and identification process, the results of QC checks, and a more detailed discussion of the statistical methods used to reduce and evaluate the benthic data are presented in Appendix F.

3.2.4.5 General AquaBlok® SITE Demonstration Quality Assurance and Quality Control. Specific QA/QC procedures for each of the various field monitoring and sampling tools are described above in Section 3.2.4.

In addition, general QA/QC procedures were adhered to during the SITE demonstration program to ensure the representativeness and usability of all data generated. Specifically, throughout the demonstration, all efforts were made to not collect any two samples of any type or deploy any two monitoring devices of any type during single events or between different sampling events any closer than approximately 6

ft apart. In addition, all efforts were made to not locate any sample or monitoring device any closer than approximately 10 ft from a cell's edge (with the exception of the control cell) to minimize potential edge effects. Accurate GPS/dGPS data were collected throughout all sampling events to achieve this end. Figures 3-16 through 3-19 show the locations of the various samples collected and monitoring tools deployed during the one-month, six-month, 18-month, and 30-month post-capping events, respectively.

Given the extensive number of monitoring tools used, the number of sampling events executed, and the number of individual samples collected, a limited number of samples were collected from less than approximately 6 ft apart between sampling events. In addition, certain monitoring tools actually required targeting similar or identical locations between sampling events. Specifically, oceanographic surveying was conducted along identical survey lines for each event by design, and SPI camera drops were conducted near one another, but not immediately atop one another, between the various SPI surveys. In addition, gas flux chambers were intentionally located in nearly identical positions between the two gas flux sampling events.

All measurements, observations, and data generated in the field during the demonstration were recorded in dedicated field journals or directly into a laptop computer for later processing. Data were processed, compiled, and analyzed both manually and by specific computer software. All data and derived products were stored in Battelle and/or laboratory/subcontractor computers, and copied to compact disc (CD) as needed. In addition, hard copy deliverables were produced by most if not all laboratories/subcontractors.

General and specific QA/QC procedures for the AquaBlok® demonstration were summarized in the project Quality Assurance and Project Plan (QAPP) (Battelle, 2004), and were adhered to other than as noted specifically in this ITER.

3.3 AquaBlok® SITE Demonstration Results

The following sections present the results of and conclusions drawn from the AquaBlok® SITE demonstration program in the Anacostia River demonstration area. For simplicity, results and conclusions are summarized by study objective rather than by individual sampling/monitoring tool.

3.3.1 Objective #1 – Physical Stability of An AquaBlok® Cap

As indicated in Section 3.2.1, the physical stability of AquaBlok® in flowing water depends primarily on the material's physical strength (e.g., shear strength) and its ability to withstand shear stresses imposed by surface water flow field currents at the cap/water interface. One of the most critical design characteristics of AquaBlok® is that, given its high degree of cohesiveness related to its material composition, it claims to have a higher resistance to shear energy compared to traditional capping materials (e.g., sand).

To evaluate the physical stability of AquaBlok® relative to sand and native sediments, the following critical and non-critical measurements were identified and assessed through data collection during the various SITE demonstration sampling events.

Critical Measurements

- Sedflume coring and analysis;
- Sediment coring and analysis of COCs;
- Bathymetry and sub-bottom profiling; and
- Side-scan sonar surveying

Non-critical Measurements

- SPI;
- Gas flux analysis; and
- Sediment coring and analysis of physical parameters

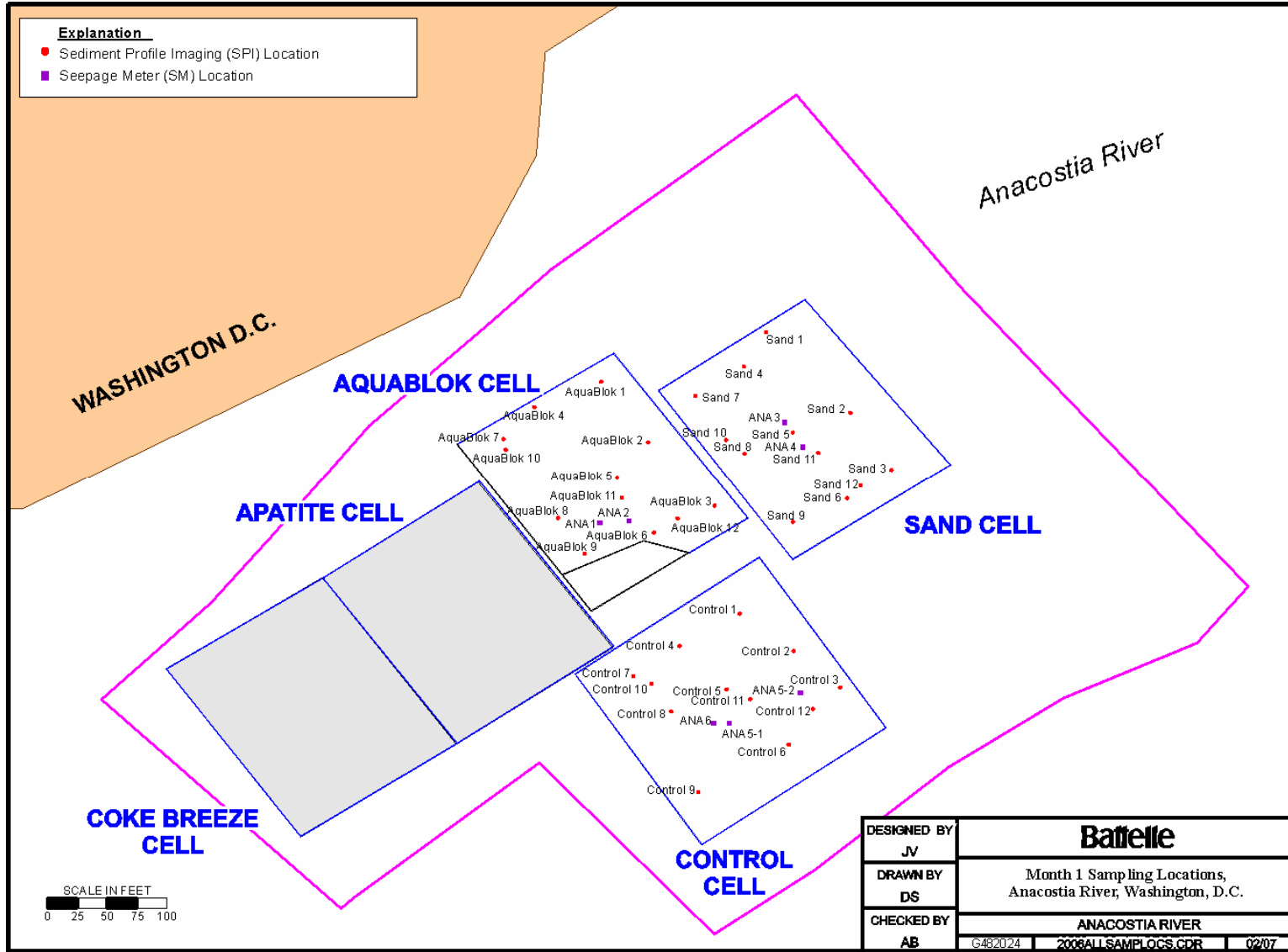

Figure 3-16. One-Month Post-Capping Field Event Sampling/Monitoring Locations

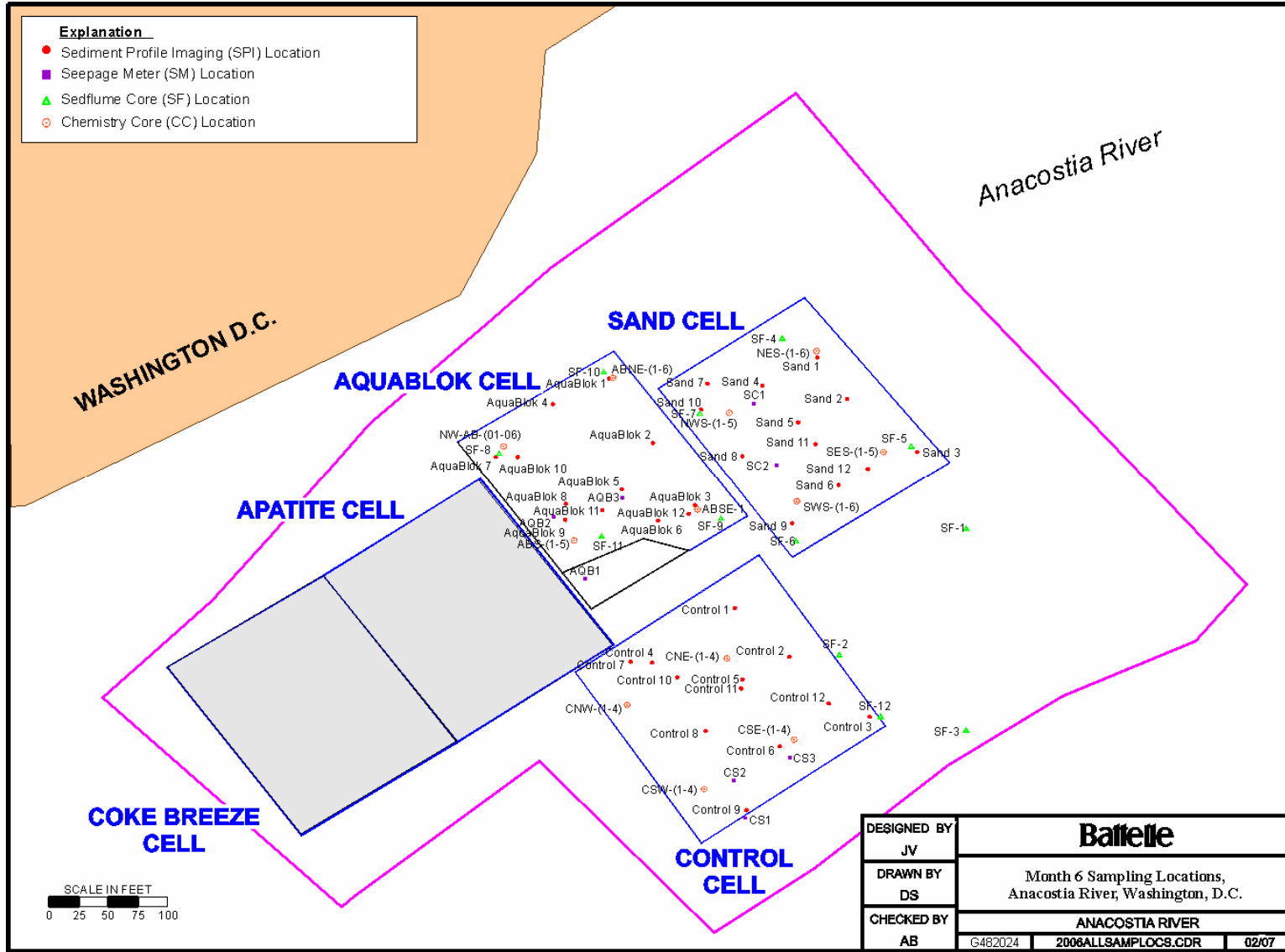

Figure 3-17. Six-Month Post-Capping Field Event Sampling/Monitoring Locations

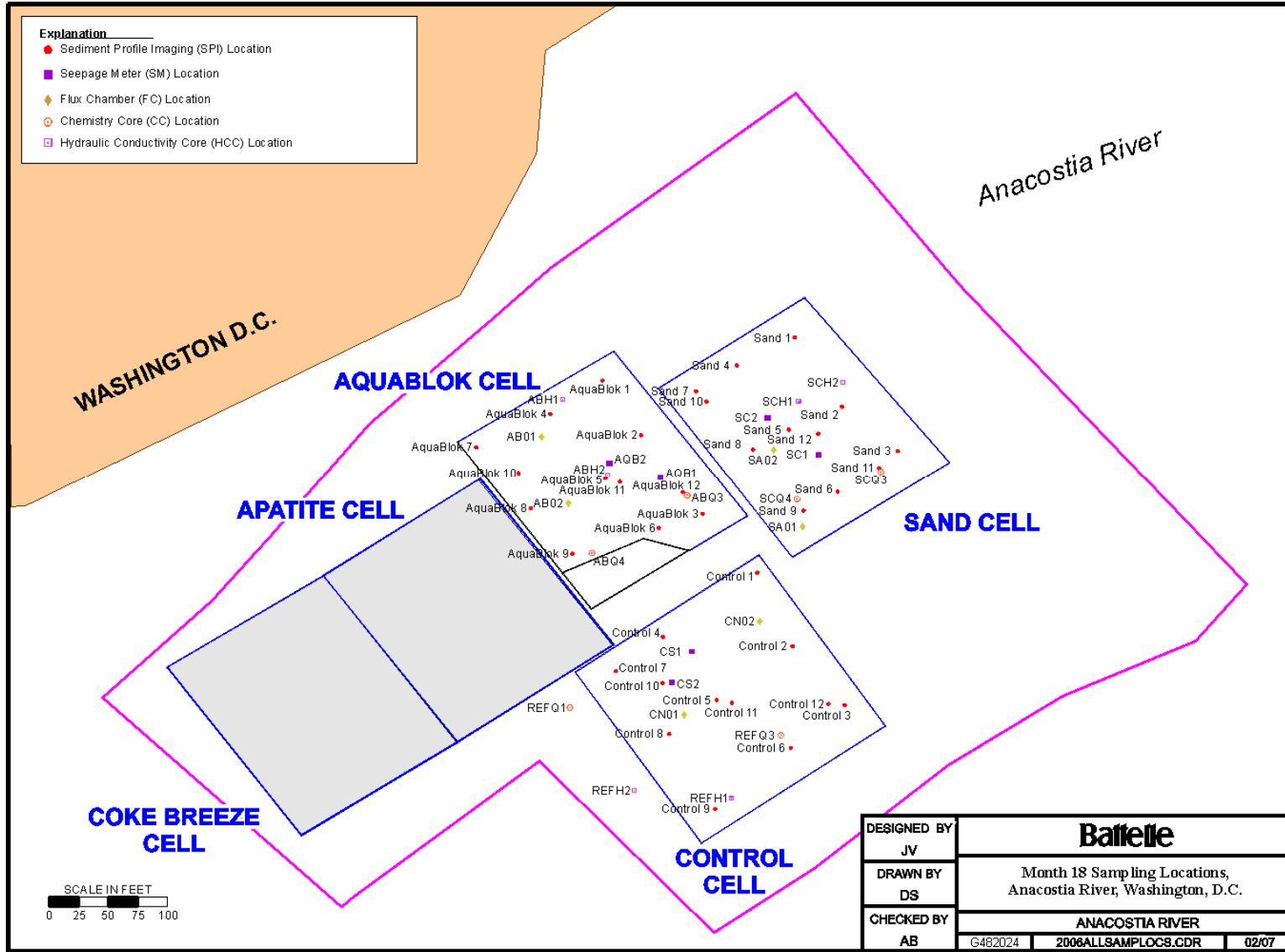

Figure 3-18. 18-Month Post-Capping Field Event Sampling/Monitoring Locations

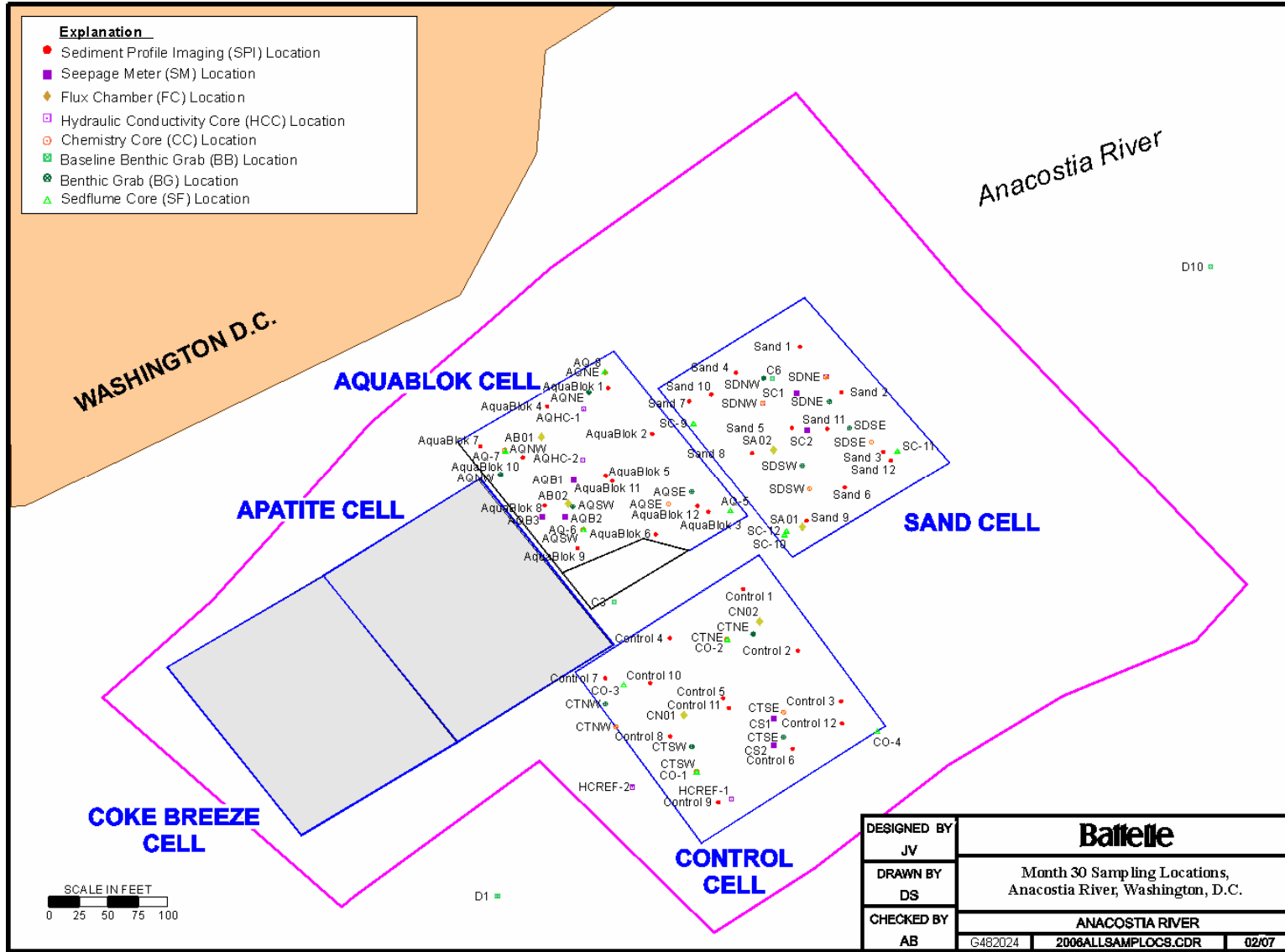

Figure 3-19. 30-Month Post-Capping Field Event Sampling/Monitoring Locations

3.3.1.1 Objective #1 Results – Critical Measurements

3.3.1.1.1 Sedflume Coring and Analysis.

Sedflume coring and analysis were conducted during the six-month and 30-month post-capping surveys, as described in Section 3.2.4. During each sampling round, 12 total Sedflume cores were collected (i.e., one per quadrant from the AquaBlok[®], sand, and control cells), as shown on Figure 3-20, and analyzed on-site in a mobile Sedflume laboratory.

Several Sedflume cores intended to target the control cell were collected either outside the determined boundary of the control cell or immediately near the boundary. This occurred presumably because of a misinterpretation of navigational position by the coring contractor. However, given that these cores were collected in identical native sediment material as that within the control cell, this does not in any way compromise data usability or representativeness. In addition, during the 30-month post-capping Sedflume evaluation, two cores were collected from the southwest quadrant of the sand cell and none from the northeast quadrant. Given that each core still captured the appropriate cap interval, this also does not compromise the Sedflume results.

The results of the six-month post-capping Sedflume analyses indicated that control sediments (i.e., native river bottom sediments) at the surface were relatively easily eroded due to the less consolidated nature of these sediments and the presence of organic detritus and gas voids. Erosion rates for the native sediments decreased at depths approaching and below 10 cm where the native sediments were still silty/clayey but were more compact and competent. For the sand cell, the capping material demonstrated greater erosion resistance compared to the native sediments, but did exhibit highly variable erosion rates due to the variable presence of organic detritus and finer-grained particles mixed with the sand. At depths approaching and below 10 cm in the sand cell Sedflume cores, material generally transitioned to native sediment and erosion rates were consistent with the native sediment cores at

equivalent depth. In the AquaBlok[®] cell Sedflume cores, the sand covering layer demonstrated erosion rates quite consistent with those observed in the sand cell cores. However, in the actual AquaBlok[®] material, erosion rates were exceedingly low and required very high shear energy to produce erosion. The shear stresses required to erode the AquaBlok[®] material were between 3.2 and 10 N/m², a range that is indicative of very high surface water energy at the sediment/water interface. In addition, this range is at least an order of magnitude higher than was required to erode the native sediment interval and significantly higher than energy required to erode the sand capping material. Additional specific data generated from the six-month post-capping Sedflume survey, including general physical data (e.g., bulk density and water content) generated to verify sediment lithology and correlate with erosion rates, is provided in Appendix E-1.

The results of the 30-month post-capping Sedflume analyses were generally consistent with the six-month Sedflume survey. Analyses conducted on control sediments (i.e., native river bottom sediments) indicated that the surface was relatively easily eroded due to less consolidated nature of the surface sediment and the presence of organic detritus and gas voids. Erosion rates for the native sediments decreased at depths approaching and below 10 cm where the native sediments were still silty/clayey but were more compact and competent. For the sand cell, the capping material demonstrated relatively low resistance to erosion consistent with or even lower than the surface of the native sediments. This was presumably due to the accumulation of fine-grained detrital sediment between the two surveys atop the sand capping material. In addition, sand in the sand cell Sedflume cores appeared to have sorted to some degree between surveys. In intervals characterized by finer grained sands, erosion rates were relatively higher than in coarser sand intervals. At depths approaching and below 10 cm in the sand cell Sedflume cores, material generally transitioned to native sediment and erosion rates were consistent with the native sediment cores at equivalent depth. In the AquaBlok[®] cell Sedflume cores, the sand layer demonstrated erosion rates quite consistent with those observed in the sand

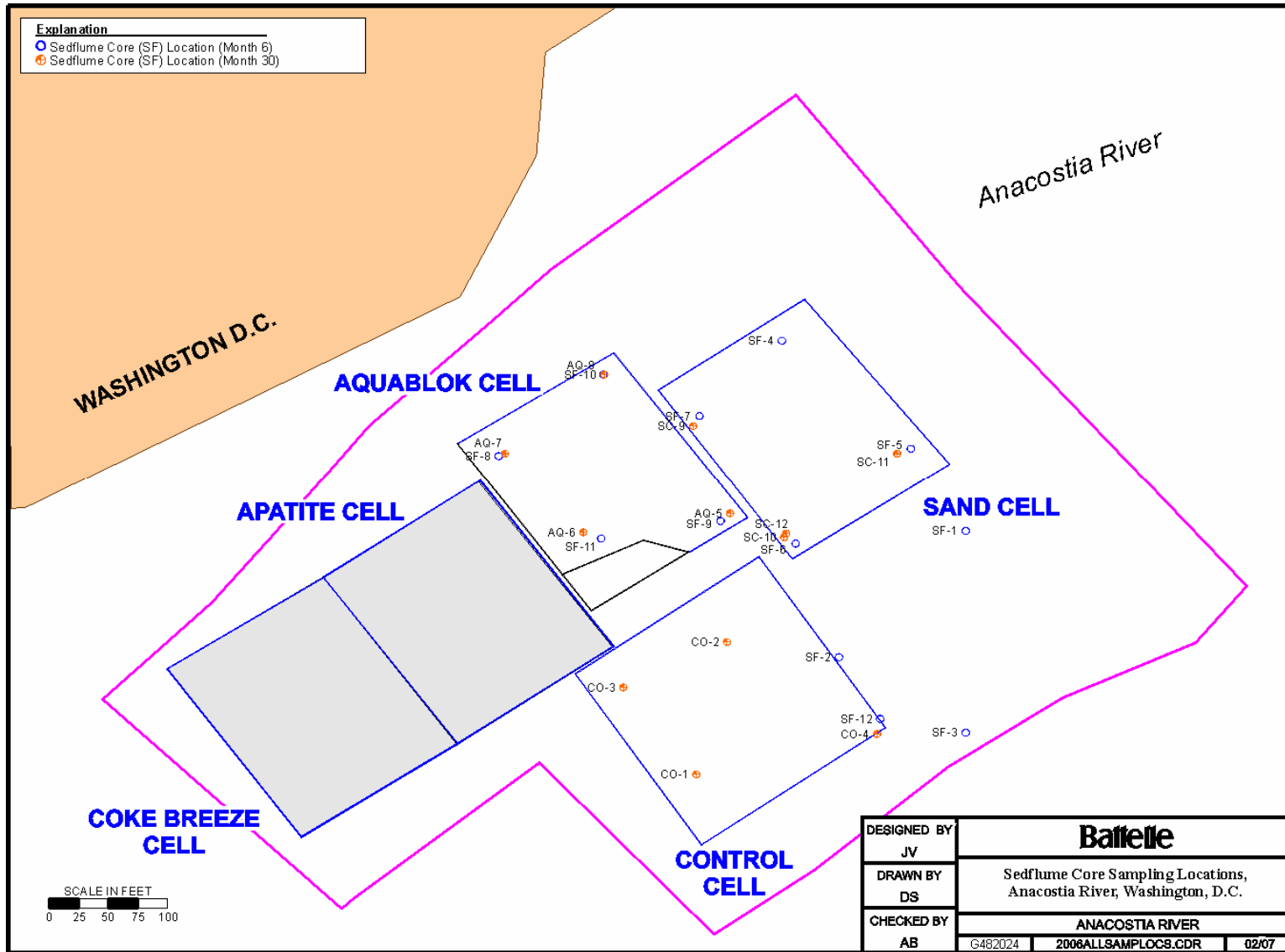

Figure 3-20. Sedflume Coring Locations

cell cores. However, in the actual AquaBlok® material, as with the previous six-month post-capping event, erosion rates were exceedingly low and required very high shear energy to produce erosion. The shear stresses required to erode the AquaBlok® material were at least 3 N/m² and up to 9 N/m², which is indicative of very high surface water energy at the sediment/water interface. In addition, this shear stress is approximately an order of magnitude higher than the energy required to erode the native sediment interval and significantly higher than the energy required to erode the sand capping material.

Additional specific data generated from the 30-month post-capping Sedflume survey, including general physical data (e.g., bulk density and water content) generated to verify sediment lithology and correlate with erosion rates, is provided in Appendix E-2.

Overall, the results of the Sedflume analyses conducted during the demonstration indicate that AquaBlok® is a highly competent and cohesive material and is unlikely to be eroded even at very high shear stresses consistent with very high flow. The results also suggest that traditional sand cap material (or a sand covering layer over an AquaBlok® cap) can be less resistant to erosion when compared to the fine-grained, organic-rich sediments common in the Anacostia River (and commonly found at most contaminated sediment sites), and may be variably resistant to erosion after layering through grain sorting. Even where characterized by erosion resistance greater than typically organic silty/clayey river bottom sediments, the data generated suggest sand would not be as resistant to erosion when compared to AquaBlok®.

With specific respect to the potential for cap failure in the Anacostia River system, it appears unlikely that either an AquaBlok® or a sand cap would be characterized by such a risk in the typically sluggish and depositional local environment of the demonstration area. Specifically, given that very high river flow events associated with significant precipitation in the Washington, DC area were documented in the Anacostia River during the demonstration and

both the AquaBlok® (see Figure 3-21) and sand caps remained stable (see Section 3.3.1.1.3), it would appear that either would be effectively stable in the range of surface water flow common to this environment. Beyond the local demonstration area environment in the Anacostia River, other research suggests that bottom shear stresses are not significant and that the likelihood of sediment movement during even storm events is not great (Roberts, 2004). Nevertheless, based on the laboratory Sedflume data generated during the SITE demonstration, AquaBlok® would be anticipated to be more stable in higher ranges of flow and accompanying bottom shear stress at any given contaminated sediment site.

3.3.1.1.2 Sediment Coring and Analysis of Contaminants of Concern.

Sediment coring and analysis of COCs was conducted during the six-month, 18-month, and 30-month post-capping surveys, as described in Section 3.2.4. During the six-month post-capping field event, two individual cores were collected from each of the four unique quadrants in the AquaBlok®, sand, and control cells, for a total of eight cores per cell and 24 total cores overall. During the 18-month post-capping field event, two individual cores were collected from two of the four unique quadrants in the AquaBlok®, sand, and control cells, for a total of four cores per cell and 12 total cores overall. During the 30-month post-capping field event, the same coring approach as the six-month post-capping event was followed (i.e., two individual cores from each of the four unique quadrants in the AquaBlok®, sand, and control cells, for a total of eight cores per cell and 24 total cores overall). Figure 3-22 displays the sediment coring locations from each of the sampling events. As indicated on Figure 3-22, a few sediment cores intended to target the control cell were collected either outside the determined boundary of the control cell or immediately near the boundary. This occurred presumably because of a misinterpretation of navigational position by the coring contractor. However, given that these cores were collected in identical native sediment material as that within the control cell, this does not in any way compromise data usability or representativeness.

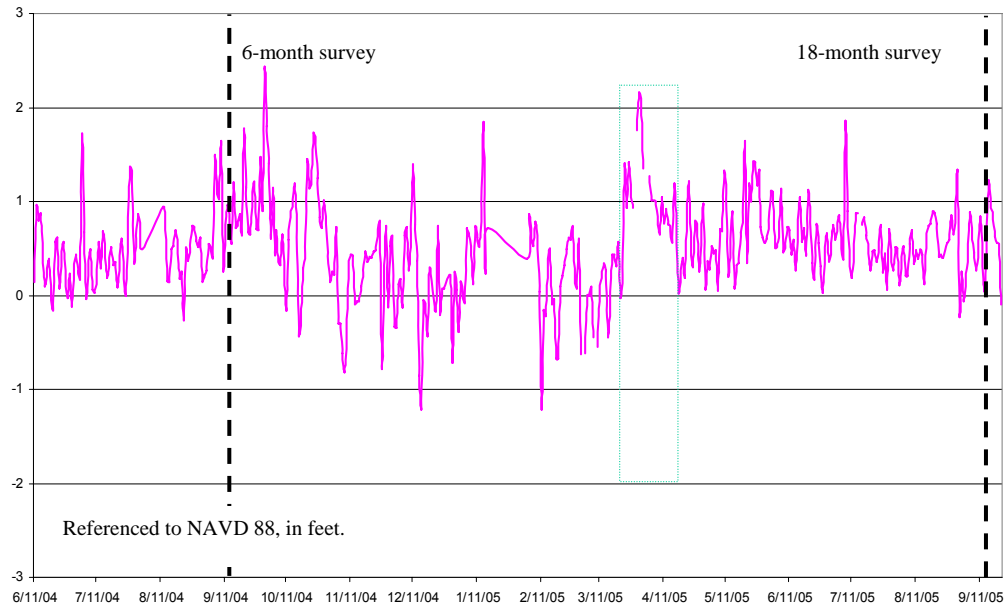
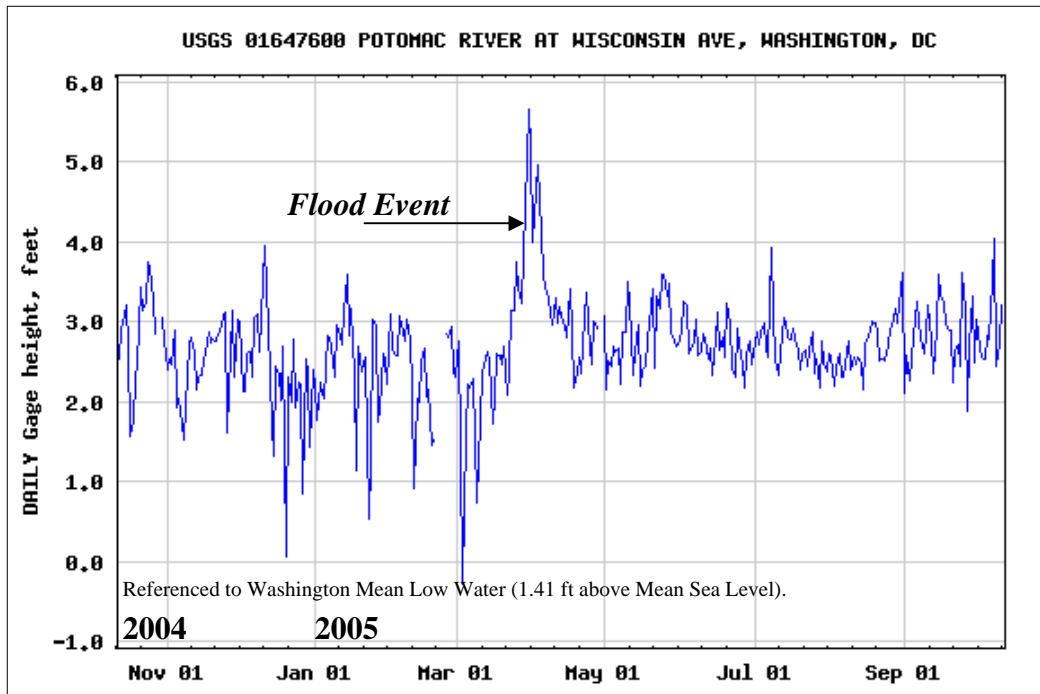

Figure 3-21. Potomac River (top) and Anacostia River (bottom) River Flows During Demonstration (flood event in top panel is highlighted in green in lower panel; from United States Geologic Survey [USGS], 2006)

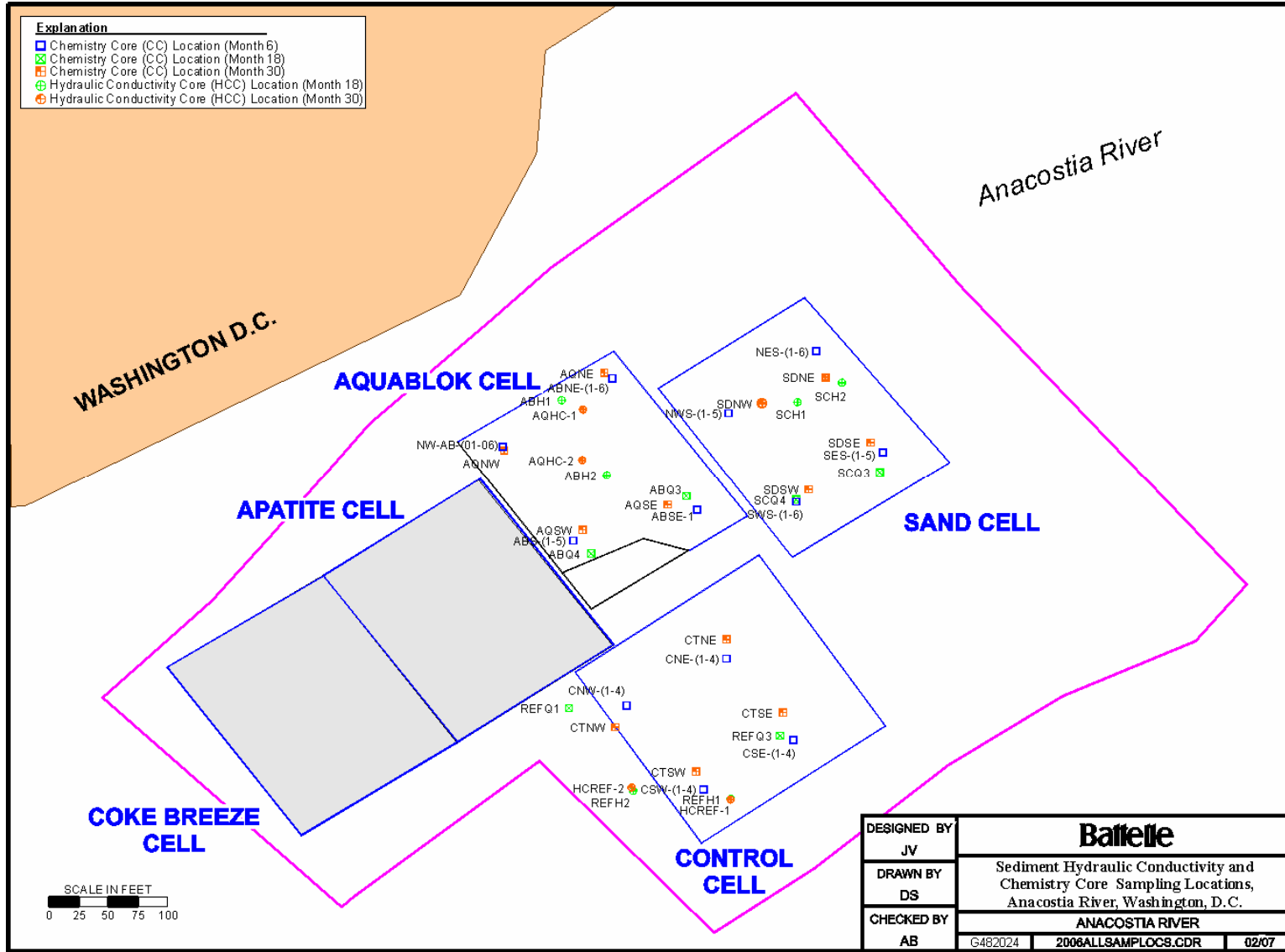

Figure 3-22. Sediment Coring Locations

During each coring event, the sampling approach was to collect the following sample intervals (each sample interval was intended to be a 3 cm vertical segment of material) depending on the actual thickness of various lithologic intervals:

- AquaBlok[®] cell: three individual samples from the overlying sand layer, one sample from the interface of the overlying sand layer and the AquaBlok[®] capping layer, three individual samples within the AquaBlok[®] capping layer, one sample from the interface of AquaBlok[®] and native sediments, and one sample from the upper horizon of the native sediment unit, for a total of nine unique samples per core.
- Sand cell: four individual samples from the sand capping layer, one sample from the interface of the sand capping layer and the underlying native sediment, and one sample from the upper horizon of the native sediment unit, for a total of six individual samples per core.
- Control cell: three individual samples from the upper horizon of the native sediment unit, for a total of three individual samples per core.

During field processing of the cores, the lithology of the cores was recorded as well as the depths of analytical samples collected and the specific analyses to be performed on each sample. This information was used to generate detailed coring logs for each sediment core or for at least one representative core from the set of replicate cores from each coring location. Coring logs are provided in Appendix G.

As indicated in Section 3.2.4, all sediment core samples were analyzed for six individual metals and a full suite of PCB congeners and PAHs. In addition, duplicate samples were collected as appropriate and analyzed for either this same set of parameters or a subset thereof. The data generated from the analysis of the sediment samples collected during the various sediment coring events are summarized in tabular form for all individual target analytes in Appendix H. For duplicate samples, concentrations were averaged. In addition, graphs in Appendix H

show the concentrations of metals, PCBs, and PAHs throughout the vertical profile of each core sampled during each coring event. These graphs are grouped by contaminant class and within each contaminant class by cell and quadrant. For simplicity, PCB graphs show only the six most commonly detected PCB congeners in the demonstration area and the PAH graphs show only the seven most commonly detected PAHs at the Anacostia study site.

Figures 3-23 to 3-25 show the total concentrations of PAHs detected throughout the vertical profile in the composited core from each quadrant in each cell. Figures 3-26 through 3-28 show the same for PCBs, and Figures 3-29 through 3-31 show the same for metals. For PAHs and PCBs, the total displayed on these graphs is the sum of all individual analytes, as opposed to the limited set of those most commonly detected in the demonstration area. For metals, the total is the sum of the six individual metals analyzed. The evaluation of data trends in Figures 3-23 to 3-31 is provided below by compound class. Note that, in general, these figures demonstrate overall lower concentrations of all COCs during the 18-month post-capping event than the six or 30-month events. This observation is not readily explained, and may be related to actual differences in COC concentrations at the variable locations sampled relative to the other monitoring events or attributable to simple laboratory variability.

PAHs

As demonstrated on Figure 3-23, total PAH concentrations in the surficial native sediments in the control cell during the six-month and 30-month post-capping coring events were generally between 20,000 and 40,000 µg/kg and declined to some extent with depth. Total surficial PAH concentrations during the 18-month post-capping coring effort were comparatively lower, which may have been an artifact of increased deposition of relatively disproportionately inorganic new sediment during this timeframe (see Sections 3.3.1.1.3 and 3.3.1.2.3). Alternatively, the variability in surficial total PAH concentrations could be related to simple laboratory analytical variability and/or the varying

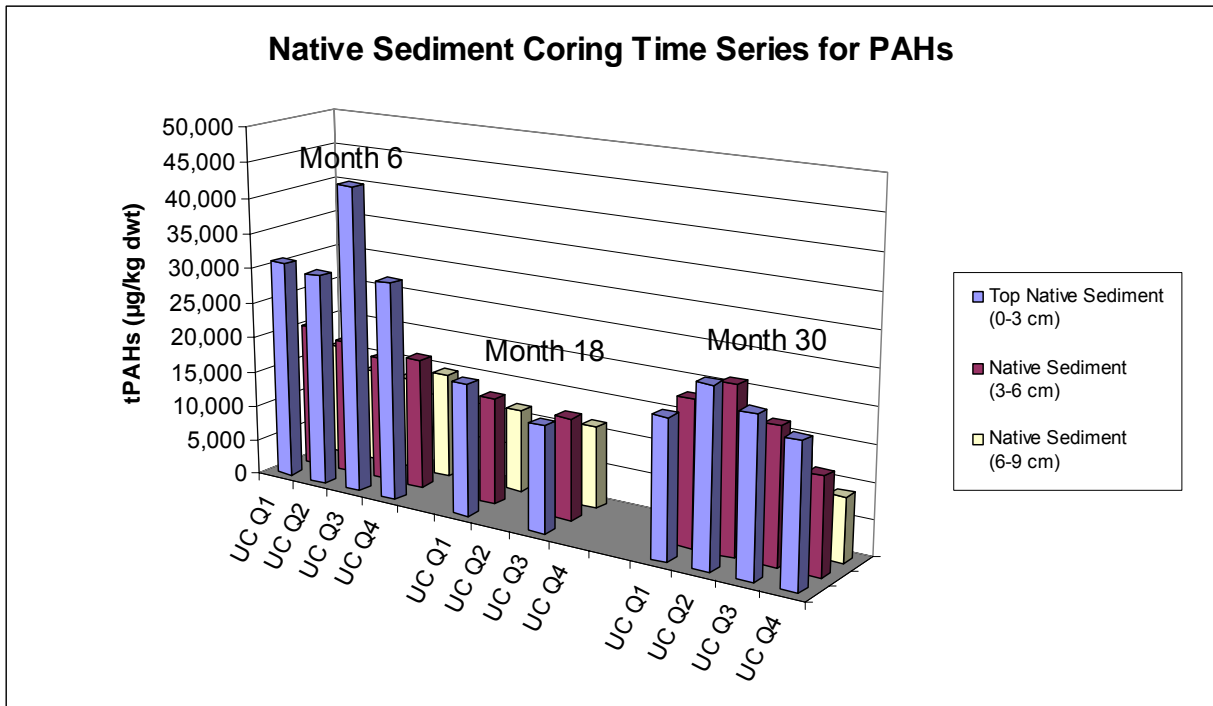

Figure 3-23. Total PAHs in Control Cell Cores

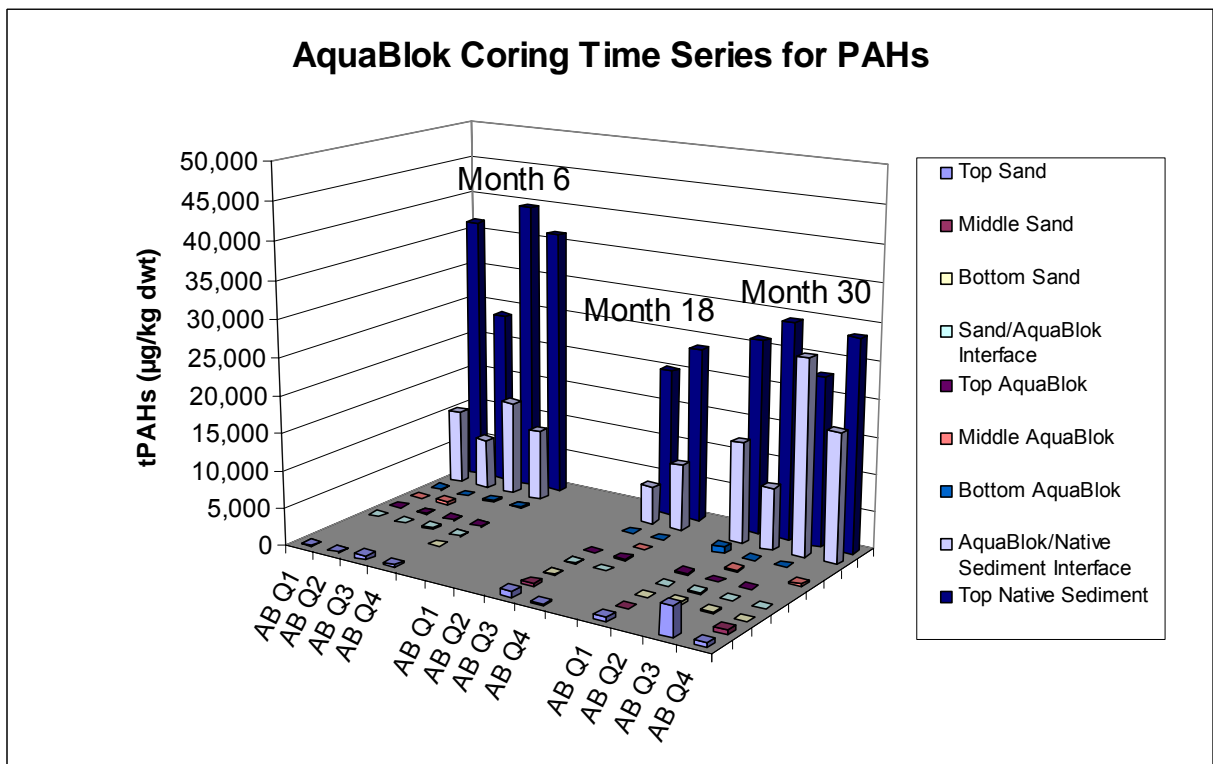

Figure 3-24. Total PAHs in AquaBlok® Cell Cores

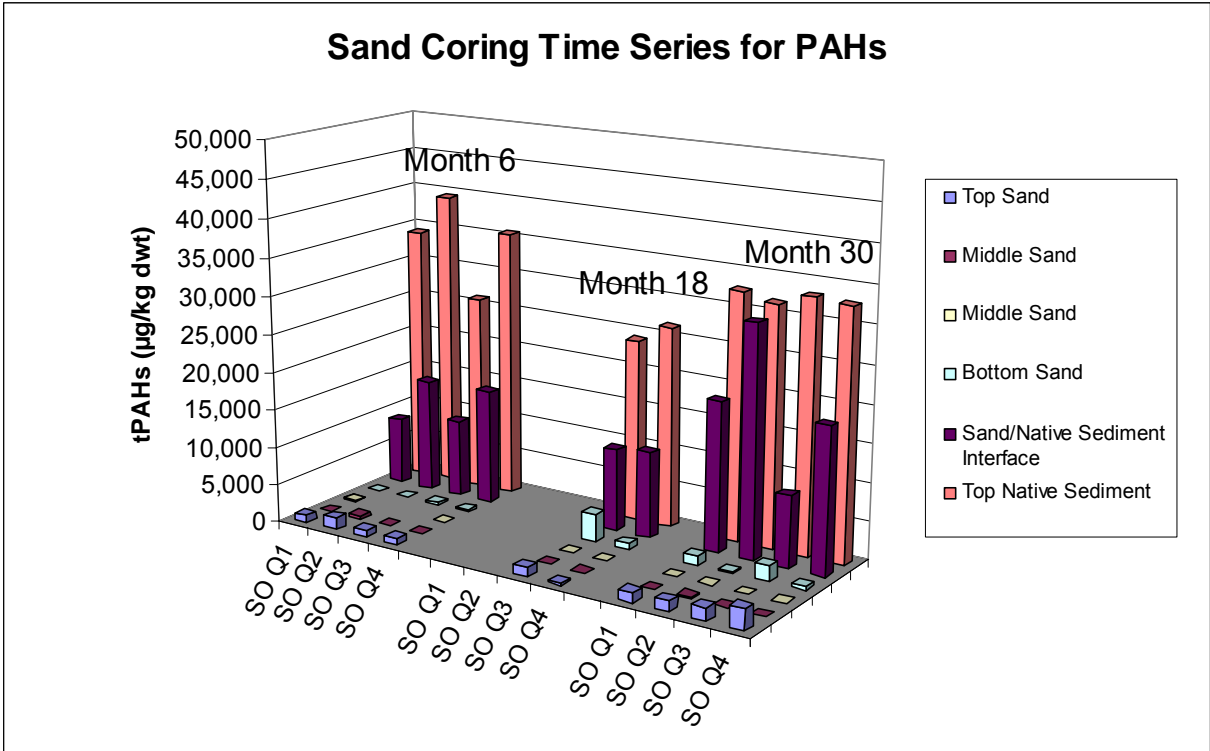

Figure 3-25. Total PAHs in Sand Cell Cores

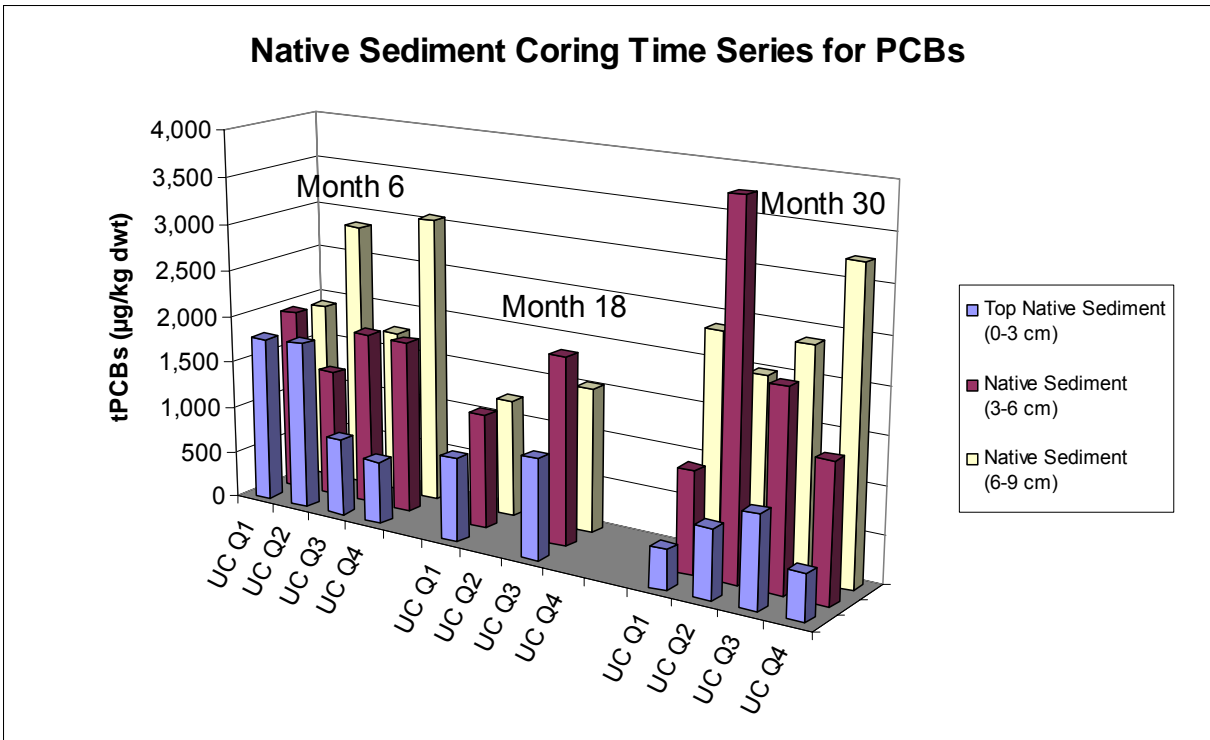

Figure 3-26. Total PCBs in Control Cell Cores

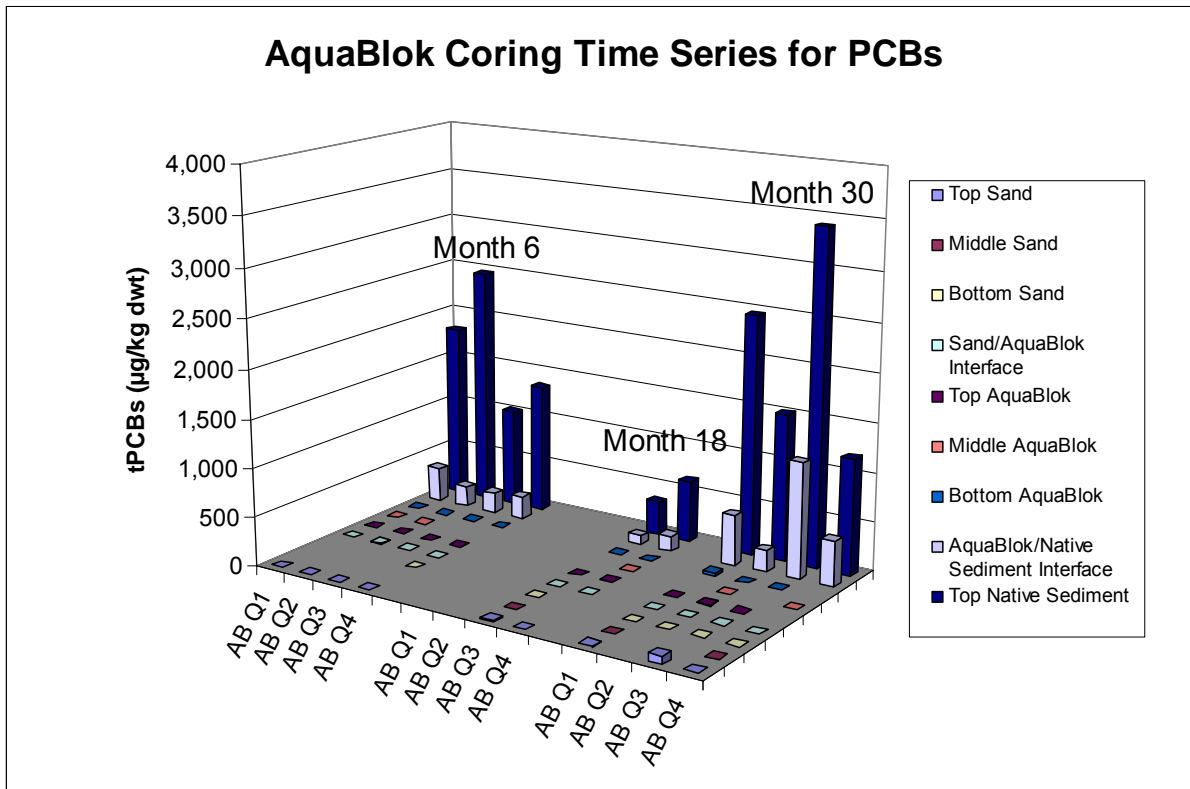

Figure 3-27. Total PCBs in AquaBlok® Cell Cores

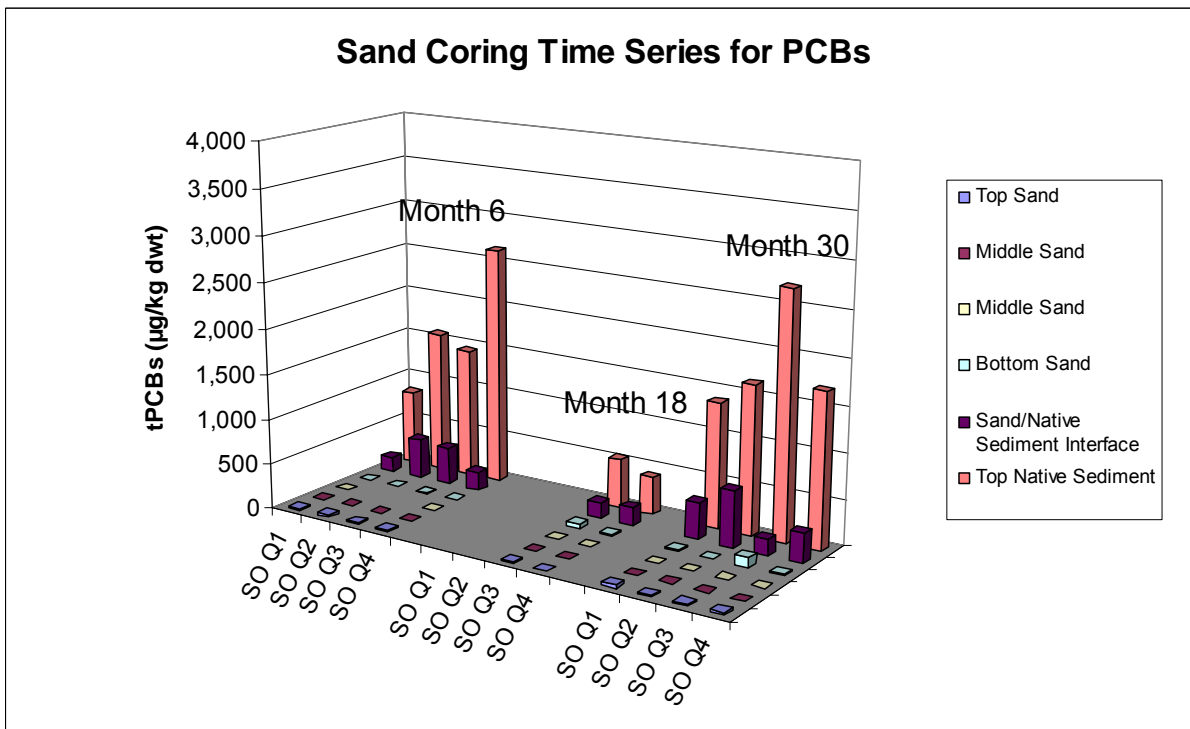

Figure 3-28. Total PCBs in Sand Cell Cores

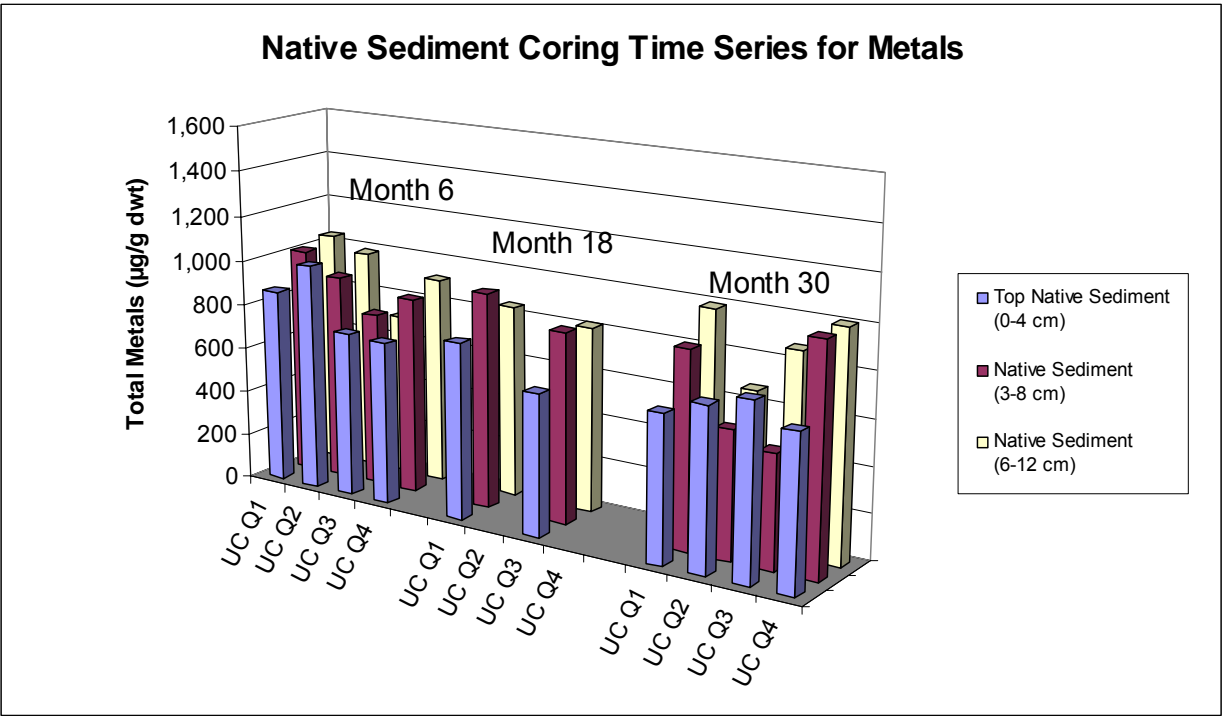

Figure 3-29. Total Metals in Control Cell Cores

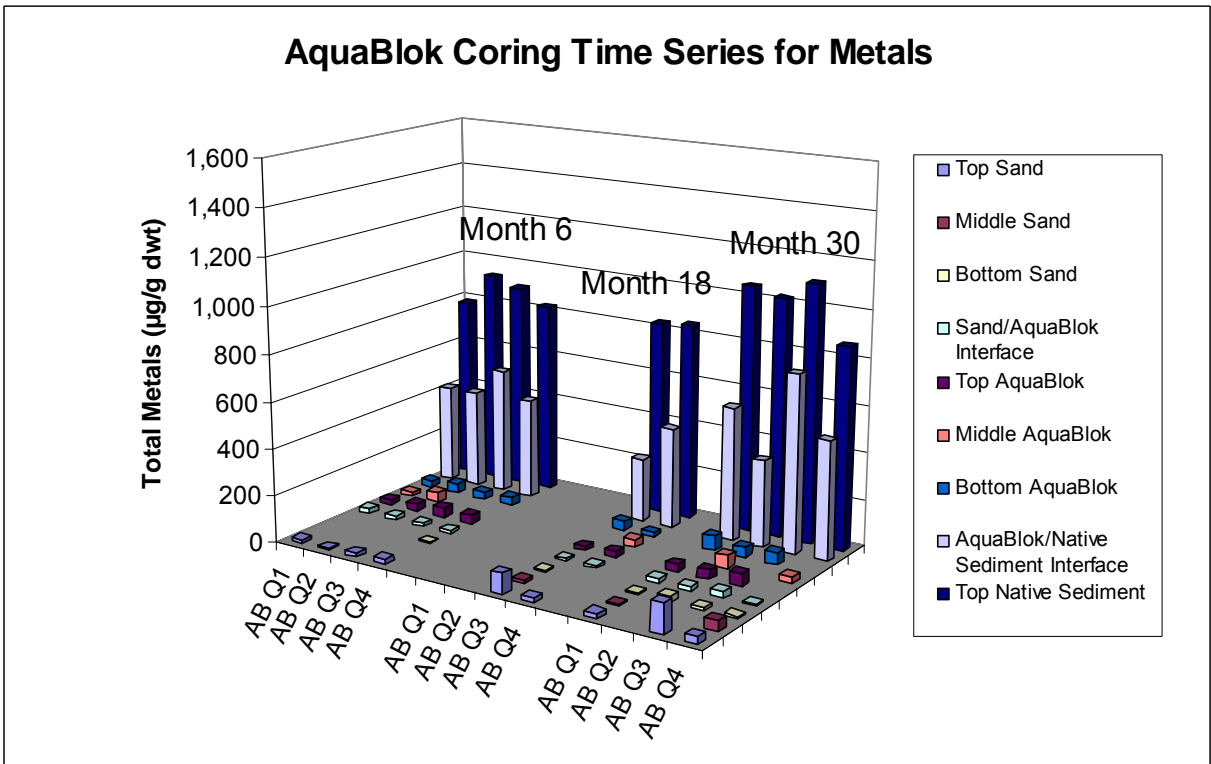

Figure 3-30. Total Metals in AquaBlok® Cell Cores

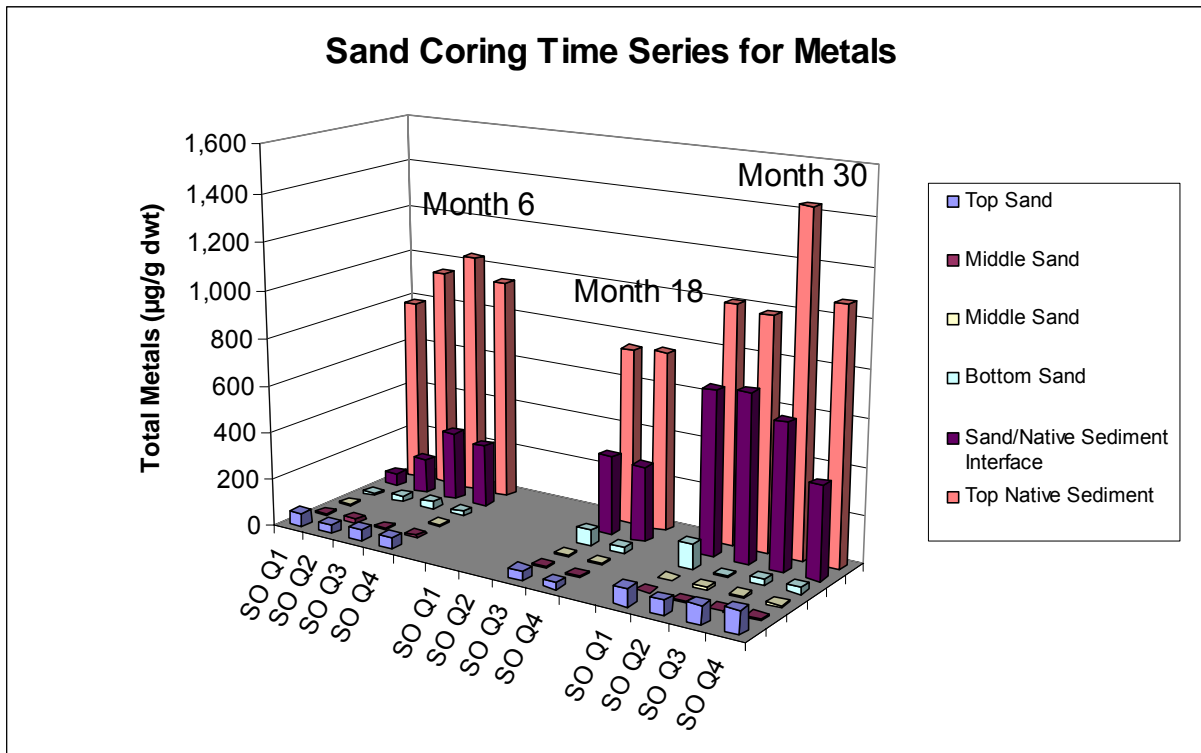

Figure 3-31. Total Metals in Sand Cell Cores

core locations. Higher total PAH concentrations at the surface in the control cell could be related to the fact that PAHs are typically a component of urban runoff and general urban pollution due to their presence in urban fill and other products (e.g., asphalt). Given that the demonstration area is located in a densely urbanized area and is immediately near a CSO, ongoing deposition of PAHs would not be unexpected. Conversely, declining total PAH concentrations with depth could be the result of continuous but limited vertical biogenic mixing combined potentially with active PAH biodegradation in the shallow subsurface sediment horizon.

Figure 3-24 shows that in the AquaBlok[®] cell, total PAH concentrations in the upper intervals of the native sediment were consistent with the control cell. Given the AquaBlok[®] cap was covering this cell throughout the demonstration and the variability in surficial native sediment total PAH concentrations is generally uniform between the various coring events in the AquaBlok[®] and control cells, it would appear this variability (for both the AquaBlok[®] and control cell) is related to

core location and/or laboratory analytical variability rather than varying degrees of ongoing contamination from urban sources. In the interface zone between native sediment and AquaBlok[®], the sample was a physical mixture of AquaBlok[®] and native sediments. The concentration of total PAHs in this interval generally declined compared to the uppermost native sediment interval, and was likely driven by the presence of PAHs in native sediment and the diluting effect of the AquaBlok[®]. PAHs were generally absent throughout the AquaBlok[®] cap material interval and over all sampling events, with the exception of a low total PAH concentration observed in the bottom AquaBlok[®] interval (i.e., the bottom-most sample of purely AquaBlok[®] material above the AquaBlok[®]/native sediment interface) in one quadrant (i.e., Quadrant 1) during the 30-month post-capping event. This could be indicative of some limited movement of PAHs upward into the AquaBlok[®] capping material, but is very limited in magnitude both empirically (i.e., a low total PAH concentration) and physically (i.e., only observed in one quadrant out of four). Interestingly, over

the course of the demonstration, PAHs appear to have accumulated to some extent on the surface of the sand covering layer in the AquaBlok® cell, which is consistent with the nature of PAHs as a likely component of urban pollution and the observed accumulation of new sediment over the course of the demonstration (see Sections 3.3.1.2.1 and 3.3.1.2.3). In addition, there appears to have been some limited degree of downward vertical mixing of this PAH contamination into intermediate levels of the sand covering layer, potentially via bioturbation.

Figure 3-25 demonstrates that in the sand cell, total PAH concentration trends were generally similar to the trends observed in the AquaBlok® cell. Specifically, total PAH concentrations in the native sediment interval beneath the sand capping layer were consistent with the control cell and AquaBlok® cell results. Also, in the interface interval between sand cap and native sediment, the sample was a physical mixture of sand and native sediments. The concentration of total PAHs in this interval generally declined compared to the uppermost native sediment interval, and was likely driven by the presence of PAHs in native sediment and the diluting effect of the sand. In addition, over the course of the demonstration, PAHs appear to have accumulated to some extent on the surface of the sand cap and vertically mixed downward to some limited extent into more intermediate levels of the sand cap, potentially through bioturbation. The most substantial difference between the sand cap and the AquaBlok® cap appears to be at the base of the capping intervals. Detectable total PAH concentrations were observed at the base of the sand cap (i.e., in the bottom-most sample of purely sand above the sand/native sediment interface zone) during both the 18-month and 30-month post-capping events. In addition, these total PAH concentrations were consistently detected across the sand cell quadrants, were generally higher than the single total PAH concentration detected in the single quadrant (i.e., Quadrant 1) during the 30-month post-capping event in the AquaBlok® cell, and demonstrated a potentially increasing trend in extent and concentration between the 18-month and 30-month post-capping events. This could be indicative of a greater degree of PAH mobility

upward into sand as compared to AquaBlok®. However, given the generally low total PAH concentrations in the basal cap intervals and the uncertainty surrounding whether some native sediment material could have been entrained in any particular sample of sand cap material, it is not possible to conclusively determine if this represents a truly varying pattern in contaminant flux between sand and AquaBlok®. Moreover, specific statistical testing was not conducted to evaluate this potential difference.

PCBs

As demonstrated on Figure 3-26, total PCB concentrations in the surficial native sediments in the control cell during the six-month and 30-month post-capping coring events were generally between 500 and 1,500 µg/kg and increased to some extent with depth to levels approaching 3,000 to 4,000 µg/kg. Total surficial and subsurface PCB concentrations during the 18-month post-capping coring effort were comparatively lower than those observed in the six and 30-month events, which may have been an artifact of increased deposition of relatively disproportionately inorganic new sediment during this timeframe (see Sections 3.3.1.1.3 and 3.3.1.2.3) that could have diluted the total PCB level. Alternatively, the variability in total PCB concentrations could be related to simple laboratory variability and/or the varying core locations. Higher total PCB concentrations at depth in the control cell are likely related to the fact that PCBs are unlikely to have any appreciable ongoing source, and therefore newly deposited sediment is likely to result in lower PCB levels at shallower depths. Given the total PAH results described above for the control cell cores, it appears likely the PCB variability during the 18-month period is also associated with coring locations and/or general laboratory analytical variability.

Figure 3-27 depicts total PCB trends in the AquaBlok® cell that are highly similar to the total PAH trends discussed above. PCBs were generally absent throughout the AquaBlok® cap material interval and over all sampling events. A very low total PCB concentration was observed in the bottom AquaBlok® interval (i.e., the bottom-

most sample of purely AquaBlok® material above the AquaBlok®/native sediment interface) in one quadrant (i.e., Quadrant 1) during the 30-month post-capping event. This could be indicative of some limited movement of PCBs upward into the AquaBlok® capping material, but is very limited in magnitude both empirically (i.e., a very low total PCB concentration) and physically (i.e., only observed in one quadrant out of four). Over the course of the demonstration, PCBs appear to have accumulated to some limited extent on the surface of the sand covering layer. Given the fact that PCBs do not likely have an appreciable ongoing source, this observation is likely related to PCBs in suspended native sediments (either from ongoing sediment transport dynamics or initial sediment suspension during capping, or both) being deposited on the capping cell. Alternatively, given the highly urbanized and industrialized nature of this portion of Washington, DC, it is conceivable that there could be some ongoing contribution of PCBs to the Anacostia River in diffuse urban runoff.

Figure 3-28 depicts total PCB trends in the sand cell that are also highly similar to the total PAH trends discussed above. As with the AquaBlok® cell, over the course of the demonstration, PCBs appear to have accumulated to some extent on the surface of the sand cap, likely for the same reason(s) as described above for the AquaBlok® cell. As with PAHs, the most substantial difference between the sand cap and the AquaBlok® cap relative to PCBs was at the base of the capping intervals. Detectable total PCB concentrations were observed at the base of the sand cap (i.e., in the bottom-most sample of purely sand above the sand/native sediment interface zone) during both the 18-month and 30-month post-capping events. In addition, these total PCB concentrations were detected in the sand cell quadrants more consistently, were generally higher than the single total PCB concentration detected in the single quadrant (i.e., Quadrant 1) during the 30-month post-capping event in the AquaBlok® cell, and appeared to demonstrate an increasing concentration trend between events. This could be indicative of a greater degree of PCB mobility upward into sand as compared to AquaBlok®. However, given the low total PCB concentrations

in the basal cap intervals and the uncertainty surrounding whether some native sediment material could have been entrained in any particular sand cap material sample, it is not possible to conclusively determine if this represents a truly varying pattern in contaminant flux between sand and AquaBlok®. Moreover, as with PAHs, this potential difference in PCB concentrations was not evaluated specifically through statistical testing.

Metals

While the evaluation of metals using the summation of component elements is not as meaningful as the summation of total PAHs or PCBs, it is informative and useful for illustrative purposes. As indicated on Figure 3-29, total metals concentrations in the control cell were generally between 600 and 1,000 mg/kg, and were generally uniform in lateral distribution and vertically throughout the upper 9 cm of native sediments.

Figure 3-30 shows that in the AquaBlok® cell, total metal concentrations in the upper intervals of the native sediment were consistent with the control cell. In the interface zone between native sediment and AquaBlok®, the sample was a physical mixture of AquaBlok® and native sediments. The concentration of total metals in this interval generally declined compared to the uppermost native sediment interval, and was likely driven by the presence of metals in native sediment and the diluting affect of the AquaBlok®. Unlike PAHs and PCBs, metals were generally present at low concentrations throughout the AquaBlok® cap material interval and over all sampling events at similar concentrations. This could be related to the nature of the AquaBlok® material itself. Being comprised of a natural earth material (i.e., bentonite clay) that itself typically contains detectable levels of some metallic constituents, it is not surprising that metals could be detected in AquaBlok®. Alternatively, bentonite clay is characterized by a high metal exchange capacity and it is therefore possible that the AquaBlok® cap strongly removes/sorbs metals from the underlying contaminated sediment. Over the course of the demonstration, metals appear to have accumulated to some

extent on the surface of the sand covering layer in the AquaBlok® cell, which is consistent with the nature of metals as a likely component of urban pollution and the observed accumulation of new sediment over the course of the demonstration (see Sections 3.3.1.2.1 and 3.3.1.2.3). In addition, there appears to have been some limited degree of downward vertical mixing of this metals contamination into intermediate levels of the sand covering layer, potentially via bioturbation.

Figure 3-31 demonstrates that in the sand cell, total metals concentration trends were similar to the trends observed in the AquaBlok® cell in some respects. Total metals concentrations in the native sediment interval beneath the sand capping layer were consistent with the control cell and AquaBlok® cell results. Also, in the interface interval between sand cap and native sediment, the sample was a physical mixture of sand and native sediments. The concentration of total metals in this interval generally declined compared to the uppermost native sediment interval, and was likely driven by the presence of metals in native sediment and the diluting affect of the sand. In addition, over the course of the demonstration, metals appear to have accumulated to some extent on the surface of the sand cap and vertically mixed downward to some limited extent into intermediate levels of the sand cap, potentially via bioturbation. Detectable total metal concentrations were observed at the base of the sand cap (i.e., in the bottom-most sample of purely sand above the sand/native sediment interface zone) during all sampling events, demonstrating a potentially increasing trend in extent and concentration throughout the course of the demonstration. This could be indicative of metals mobility upward into the sand. However, given the low total metals concentrations in the basal sand cap interval and the uncertainty surrounding whether some native sediment material could have been entrained in any particular sand sample, it is not possible to conclusively determine if this is indicative of metal flux into the sand cap. Moreover, as with PAHs and PCBs, this potential trend was not evaluated through specific statistical testing.

Overall, the sediment coring and COC analyses conducted during the demonstration suggest that the sand cap and AquaBlok® cap have remained both physically stable (i.e., observations of the cores indicated no appreciable changes in lithology from event to event) and have been effective at preventing the upward movement of contamination. There appears to have been some ongoing contribution of PAHs, PCBs, and metals at the sediment surface evidenced by the detection of these compounds in the uppermost core intervals. PAHs and metals are likely present in diffuse urban pollution emanating from Washington, DC, and PCBs could also be a component of ongoing urban pollution given the highly urbanized and industrialized nature of the region. In addition, these contaminants could be present in suspended sediment released from areas not capped through natural sediment transport in the Anacostia River system and/or from sediment resuspended during capping and subsequently redeposited in the demonstration area. No specific sampling or monitoring was conducted during the demonstration to determine the origin of contaminants at the surface. While there did appear to have been at least some downward mixing of contaminants from the surface, potentially though bioturbation, there did not appear to be a significant degree of vertical mixing of contamination from the surface downward.

The available data suggest that there may be some increased movement of contaminants from native sediments upward into the sand cap as compared to the AquaBlok® cap, but neither cap demonstrated significant accumulation of contamination or contaminant breakthrough. Specifically, PCBs and PAHs were detectable in the lowest intervals of the sand cap in the sand cell more frequently and at higher concentrations than in the AquaBlok® material in the AquaBlok® cell, and also appeared to show an increasing concentration trend throughout the demonstration that was not observed in the AquaBlok® data. Metals data were more difficult to evaluate given that common earth materials, and specifically the clay material used to create AquaBlok®, could contain metals at varying concentrations and are characterized by a high exchange capacity that could lead to ready binding of metals from native

sediments. While the sand cap appeared to demonstrate a similar mobility trend for metals as compared to PAHs and PCBs, the AquaBlok® cell demonstrated either an even greater mobility trend for metals (i.e., related to strong metals uptake/sorption characteristics) or simply the signature of metals that are a part of typical bentonite clays. The evaluation of the chemical data is complicated by the fact that initial contaminant displacement/movement and potential mixing during cap construction was not specifically studied, and could be a strong influence on the observed contaminant concentrations in the capping intervals in the sand and AquaBlok® cells. Moreover, in general, the temporal dataset generated through the demonstration is not sufficient to allow for a complete determination of the potential mobility of contamination in either capping cell or the specific differences between contaminant migration in the capping cells or between discrete contaminant classes within and across cells.

3.3.1.1.3 Bathymetry and Sub-Bottom Profiling.

Bathymetric and sub-bottom profiling surveys were conducted during the one-month, six-month, 18-month, and 30-month post-capping surveys, as described above in Section 3.2.4. Each survey was conducted by traversing the identical series of 29 survey transects oriented parallel to the shore (see Figure 3-32). Accurate positional control was achieved by operating the survey vessel in a very controlled fashion and by using a dGPS linked to accurate navigational software.

The primary objectives of the bathymetric and sub-bottom profiling were to determine the overall thickness of capping material in the AquaBlok® and sand cells as well as the thickness of various layers in these cells where relevant (i.e., AquaBlok® versus overlying sand in the AquaBlok® cell) and changes in these thicknesses over time. These measures in turn were intended to describe the in-place stability of AquaBlok® relative to sand capping material and native sediments in a real world flow regime.

During each of the sub-bottom surveys conducted, the “chirp” profiler was unable to resolve sub-bottom stratigraphy. This was likely

related to the presence of biogenic gases in the organic and decompositional environment characteristic of the site. Such gases typically represent a barrier to acoustic signal propagation and prevent the sub-bottom profiling equipment from penetrating below the interval of gas production. As the interval of gas production in the Anacostia River bottom sediments is surficial, the “chirp” profiler was unable to penetrate even beyond the very shallow sediment horizon. Frequently, this condition manifests itself as a sub-bottom profiler signal return that contains the sediment surface as a distinct feature followed by “echoes” of the surface rather than true vertical lithologic contacts. This data pattern was observed for all SITE demonstration sub-bottom surveys. As such, the sub-bottom surveying component of the SITE demonstration program was unsuccessful in providing meaningful information to assess the stability of AquaBlok® other than by providing a measure of sediment surface topography redundant with other measurement tools.

During the one-month post-capping bathymetric survey, water depths in the demonstration area ranged from approximately 4.5 ft nearer shore to approximately 19.5 ft nearer the river channel. The riverbottom sediment surface exhibited a northwest to southeast trending slope from the shoreline towards the river channel at an average 4% grade. To derive the overall thickness of the cap in each cell from these bathymetric data, the survey data from a pre-capping survey (note a pre-capping bathymetric survey was conducted that was not part of the SITE demonstration summarized in this ITER) was subtracted from the one-month post-capping survey data, yielding essentially a total cap thickness (i.e., all material placed on the native sediment surface during cap construction). Given the spacing of the bathymetric survey transects, this cap thickness information could be plotted in three dimensions over the entire plan area of the demonstration area. The one-month post-capping bathymetric data indicated that the cap thickness in the sand cell was 0.25 ft or less around the perimeter of the cell to a maximum of 1.25 ft in the southwest corner of the cell. In the AquaBlok® cell, total cap thickness was 0.25 ft or less in the southernmost portion of the cell to a maximum of 1.75 ft in the

northeastern corner of the cell. These results generally confirm the information recorded during cap placement, including the generally thicker placement of AquaBlok® where capping in this cell was initiated (i.e., the northeast cell corner)

and the shortage of material to cap the southwestern cell corner (see Section 3.1.1 and Figure 3-4). These results also generally corroborate that design cap thicknesses were achieved. Figure 3-33 shows the three-

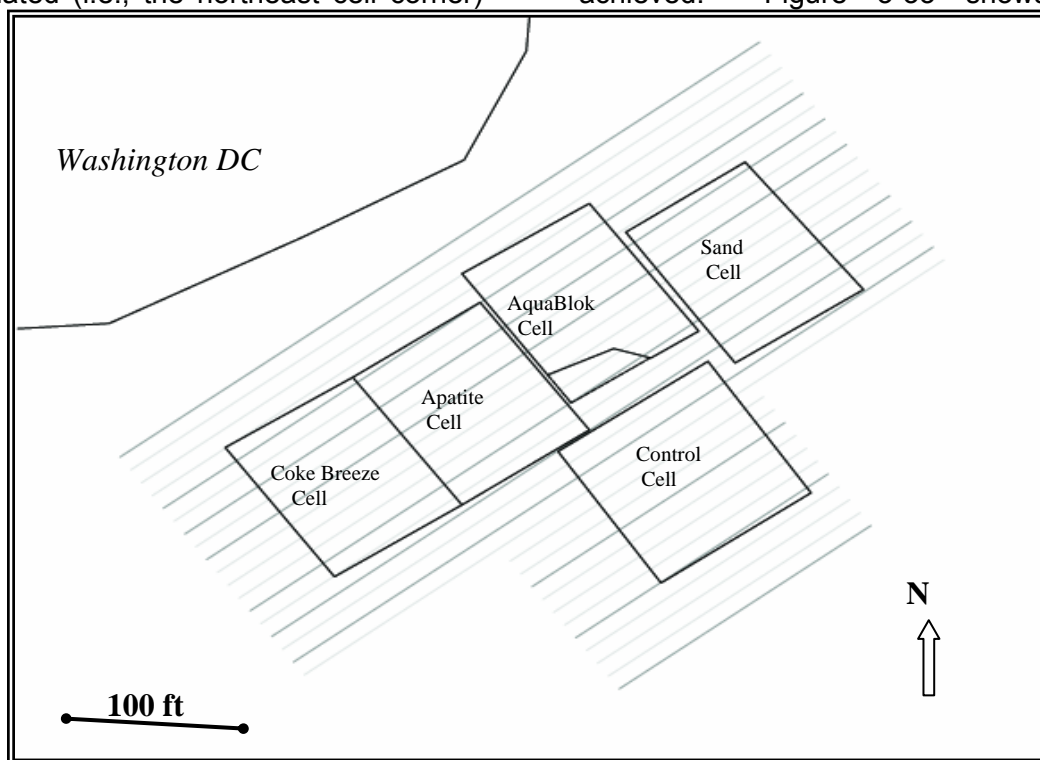

Figure 3-32. Survey Transects in Demonstration Area for Oceanographic Surveying (Side-Scan Sonar Transects Bolded)

dimensional cap thickness map of the demonstration area derived from the one-month post-capping bathymetry data. Other specific data output from the one-month post-capping survey is provided in Appendix B-1.

The six-month post-capping bathymetric data indicated highly consistent water depths (i.e., generally between 4 and 20 ft) and the same river bottom slope (i.e., 4%) as the one-month post-capping survey. Total cap thickness was derived by subtracting the baseline bathymetric data from the six-month post-capping data, and indicated generally identical total thickness across the demonstration area as compared to the one-month post-capping survey. In addition, the one-month post-capping survey data were subtracted from the six-month post-capping survey data to determine the net change in total cap thickness

between these events. This difference operation indicated that between the one-month and six-month post-capping surveys there was very little net change in the total cap thickness in both the AquaBlok® and sand cells. This net change was at most +/- 0.25 ft, which is roughly equivalent to the accuracy of the bathymetric equipment. A plot specifically demonstrating the total cap thickness difference between the one-month and six-month post-capping surveys, as well as other specific data output relevant to the six-month post-capping survey, is provided in Appendix B-2.

Similar assessments were completed using the 18-month and 30-month post-capping bathymetry datasets. Water depths and sediment surface slopes during these surveys were both highly consistent with the one-month and six-month post-capping surveys (i.e., water depths between

4 and 18 ft during the 18-month survey and between 6 and 16 ft during the 30-month survey and an average grade of approximately 4% for each).

For the 18-month post-capping bathymetric dataset, a total cap thickness plot was developed by subtracting the baseline dataset. The total cap thickness results from this operation indicated thicknesses highly similar to the previous surveys. In addition, a difference plot was created by subtracting the one-month post-capping dataset from the 18-month post-capping dataset, effectively producing a representation of total cap thickness change since installation. This assessment indicated a net increase of material generally throughout the demonstration area. This net increase in cap material was generally of limited magnitude (i.e., 0.25 ft or less) and extent, and generally was not observed in the AquaBlok® and sand cells where cap thickness appeared highly consistent with previous surveys. The net increase in cap thickness is presumably related to high flow events that occurred in the Anacostia River between the six-month and 18-month surveys, most notably in the spring of 2005 when several major storm events occurred in the site area. These high flow events could presumably have transported material into the demonstration area, which is characteristically a depositional environment. However, given the inherent accuracy of bathymetric survey equipment and the fact that even storm events in the Anacostia River are not likely to mobilize sediment to any significant degree (see Section 3.3.1.1.1; Roberts, 2004), this observed overall net increase may have not been real but a simple artifact of the data reduction. Appendix B-3 provides all of the specific data output from the 18-month post-capping survey, including the difference evaluations described above and other comparisons between survey rounds.

For the 30-month post-capping bathymetric dataset, a total cap thickness plot was developed by subtracting the baseline dataset as with all other surveys. The total cap thickness results from this operation indicated thicknesses highly similar to the previous surveys. Figure 3-34 shows the three-dimensional cap thickness map

of the demonstration area derived from the 30-month post-capping bathymetry data. In addition, a difference plot was created by subtracting the one-month post-capping dataset from the 30-month post-capping dataset, effectively producing a representation of total cap thickness change since installation. This assessment indicated that between the one-month and 30-month post-capping surveys there was very little net change in the total cap thickness in both the AquaBlok® and sand cells. This net change was generally +/- 0.25 ft, which is roughly equivalent to the accuracy of the bathymetric equipment. Appendix B-4 provides all of the specific data output from the 30-month post-capping survey, including the difference evaluations described above and other comparisons between survey rounds.

Overall, the bathymetric data generated during the SITE demonstration indicate that the AquaBlok® cap and the sand cap are highly stable in the demonstration area. However, these data do not directly describe the AquaBlok® material itself as the sand surface layer installed over the AquaBlok® was itself highly stable. Therefore, the AquaBlok® was not directly exposed to flow at the sediment/water interface. In addition, the traditional sand cap was similarly stable as compared to the sand covering the AquaBlok® material, meaning that a comparative evaluation of stability between sand and AquaBlok® is not possible on the basis of bathymetric data alone. Moreover, even with high flow conditions linked to significant storm events documented in the flow record for the Anacostia River, the sand covering the AquaBlok® cap and the traditional sand cap remained relatively unchanged throughout the SITE demonstration. This interpretation is, however, complicated by the inherently limited resolution of the data collection tools and the fact that the demonstration area is in a characteristically depositional environment and may not itself have been exposed to any significant degree to the increased energy of high flow events. Nevertheless, given that the AquaBlok® cap design for the SITE demonstration is relatively standard, the bathymetric data collected support that this approach yields a stable cap.

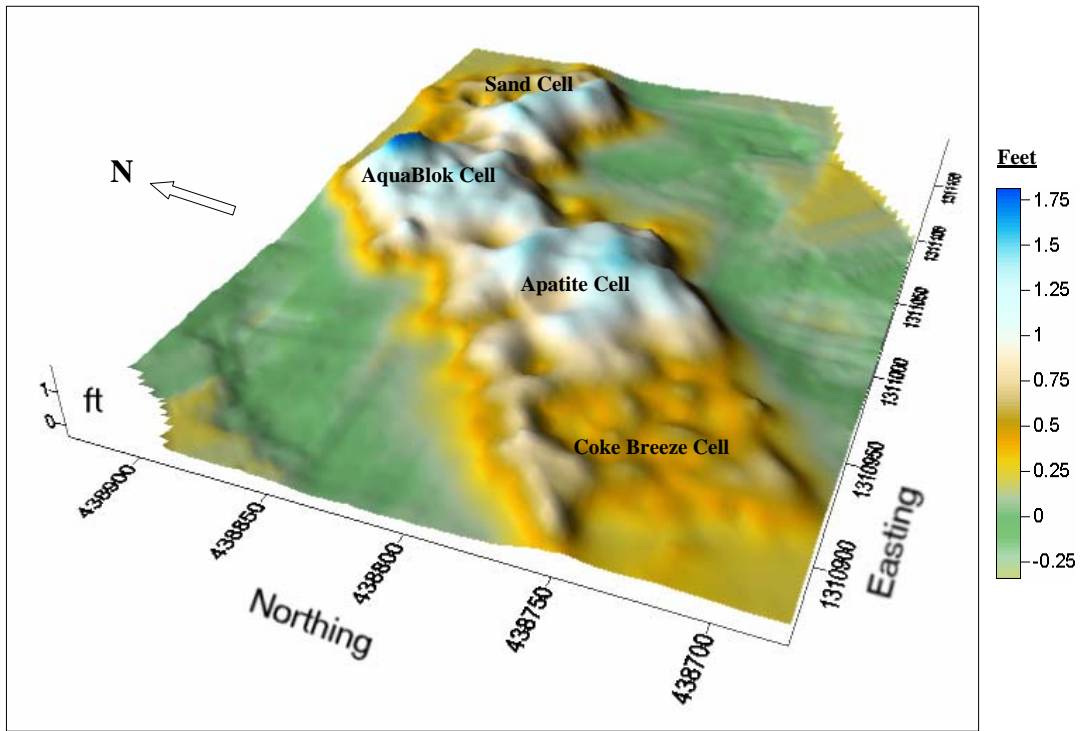

Figure 3-33. One-Month Post-Capping Bathymetric Cap Thickness Map

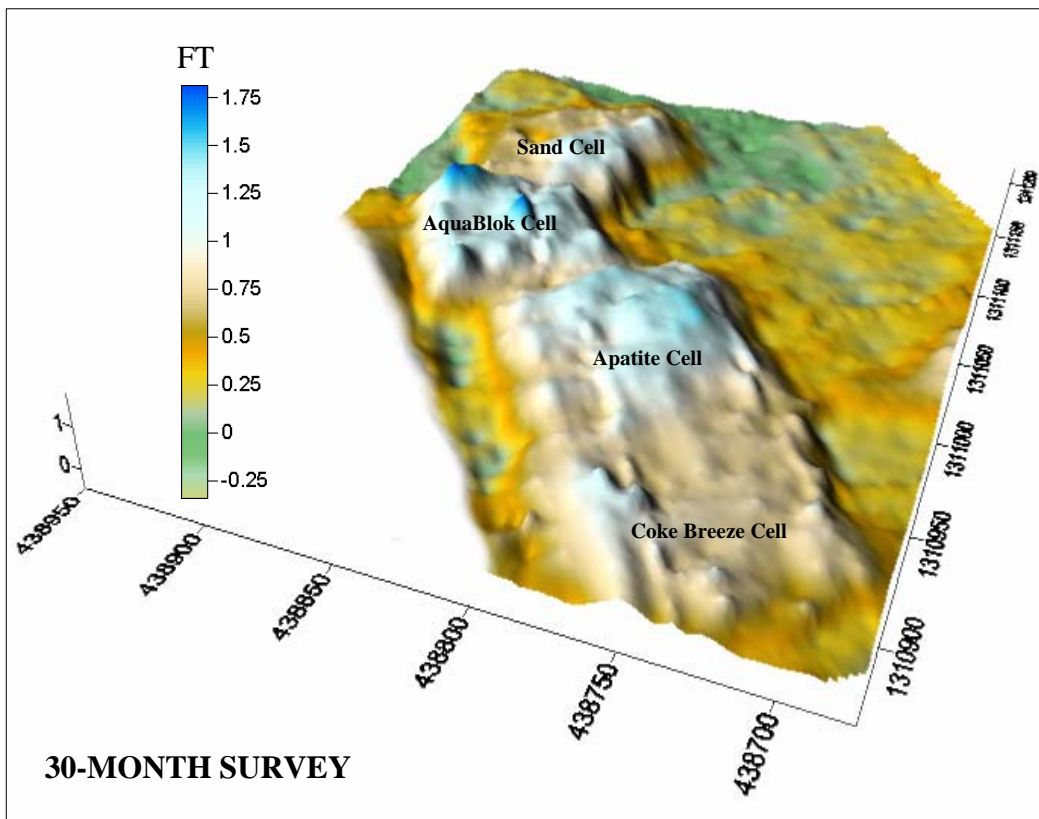

Figure 3-34. 30-Month Post-Capping Bathymetric Cap Thickness Map

3.3.1.1.4 Side-Scan Sonar Surveying.

Side-scan sonar surveys were conducted during the one-month, 18-month, and 30-month post-capping surveys, as described above in Section 3.2.4. Each side-scan sonar survey was completed by traversing the identical series of 10 survey transects oriented parallel to the shore (see Figure 3-32). These 10 transects were a subset of the 29 transects used for the bathymetric surveying. Accurate positional control was achieved by operating the survey vessel in a highly controlled fashion and by using a dGPS linked to accurate navigational software.

The primary objectives of the side-scan sonar surveys were to determine the general surface characteristics of the AquaBlok® and sand caps and the native sediment control cell, and to support the conclusions derived from the bathymetric surveying.

Side-scan sonar surveys provide a plan view image analogous to a high-angle aerial photograph. The one-month post-capping side-scan sonar survey demonstrated relatively dark signal returns characteristic of generally coarse grained material (i.e., sand) in both the AquaBlok® and sand cell, and lighter signal returns characteristic of fine grained material (i.e., silt and clay) in the control cell. Overall, the side-scan sonar image was highly consistent with the three-dimensional representation of cap thickness provided by the bathymetric data, showing the same irregular surface topography. Figure 3-35 is the side-scan sonar mosaic from the one-month post-capping survey. Appendix B-1 provides this same mosaic and additional detail related to the one-month post-capping side-scan sonar surveying.

The 18-month post-capping side-scan sonar survey was generally consistent with the one-month post-capping survey. Overall, the AquaBlok® and sand cells were characterized by darker signal returns indicative of the sand surface layer in both cells, while the control cell was characterized by lighter signal returns indicative of the silty/clayey native sediment material. The surface topography evident in the 18-month post-capping survey was irregular, consistent with bathymetric data and the one-

month post-capping sonar survey. Several objects were identified in the 18-month post-capping side-scan sonar survey lying on the sediment surface in the demonstration area. These objects were presumably debris items such as tree branches or logs that might have been deposited as a result of the storm events documented in the area prior to the 18-month post-capping field activities. In addition, the side-scan signal returns over much of the demonstration area during the 18-month post-capping survey were slightly darker in nature compared to the one-month post-capping survey. This may be indicative of the deposition of a surface layer of differing texture leading up to the 18-month post-capping survey. Both findings are generally consistent with the bathymetric survey data gathered during the 18-month post-capping evaluation. Appendix B-3 provides a side-scan sonar mosaic and additional detail related to the 18-month post-capping side-scan sonar surveying.

The 30-month post-capping side-scan sonar survey showed generally light returns across the demonstration area, inconsistent with the return pattern from the one-month and 18-month post-capping surveys. In addition, the surface topography throughout the demonstration area did not show the irregular characteristic observed in the previous two surveys but was rather generally flat. The light sonar returns and flat surface appearance may be related to the accumulation of a thin layer of silty/clayey detrital sediment following the 18-month post-capping survey, or could be related to the sonar apparatus being run at an inappropriate setting. Surface objects consistent with the presumed debris items observed in the 18-month post-capping survey were also observed in the 30-month post-capping side-scan sonar data. Figure 3-36 is the side-scan sonar mosaic from the 30-month post-capping survey. Appendix B-4 provides this same side-scan sonar mosaic and additional detail related to the 30-month post-capping side-scan sonar surveying.

Overall, the results of the side-scan sonar surveying conducted during the SITE demonstration program corroborate the results of the bathymetric surveying summarized in Section

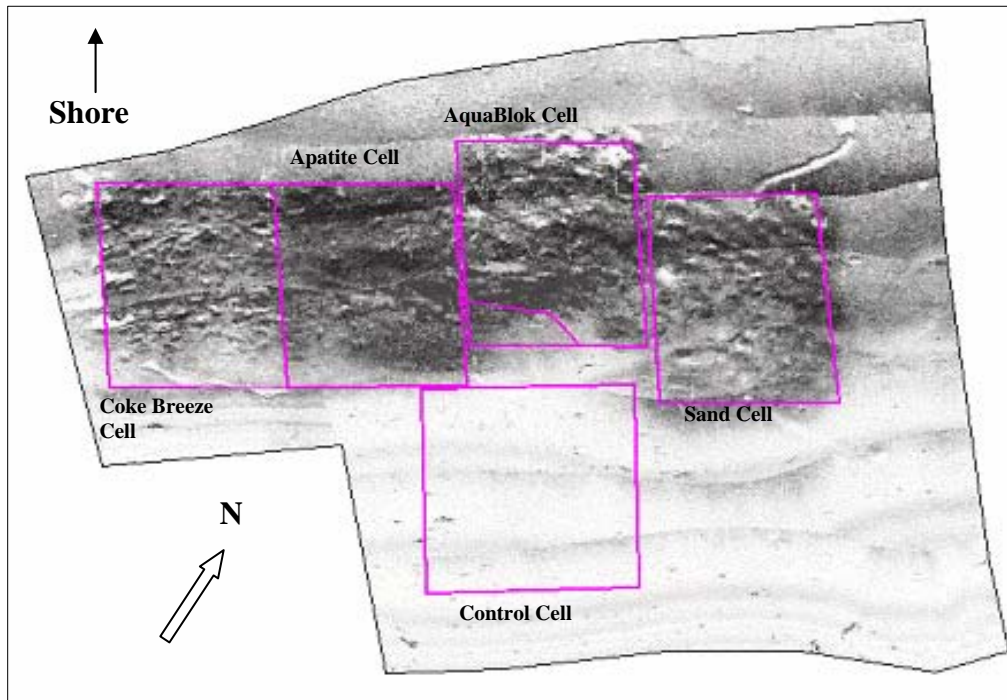

Figure 3-35. One-Month Post-Capping Side-Scan Sonar Map

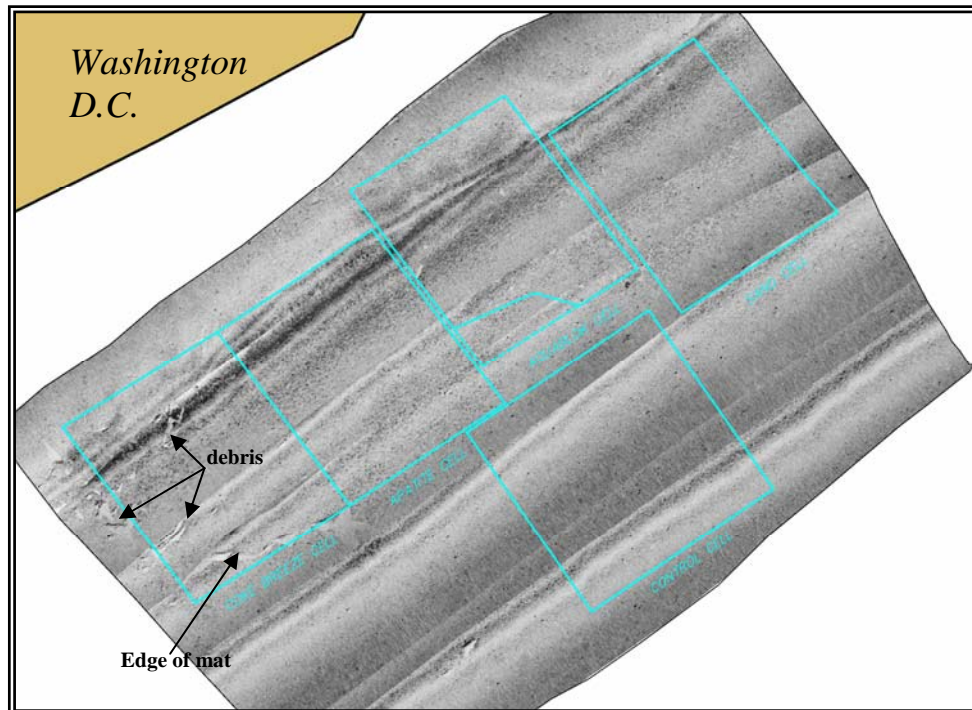

Figure 3-36. 30-Month Post-Capping Side-Scan Sonar Map

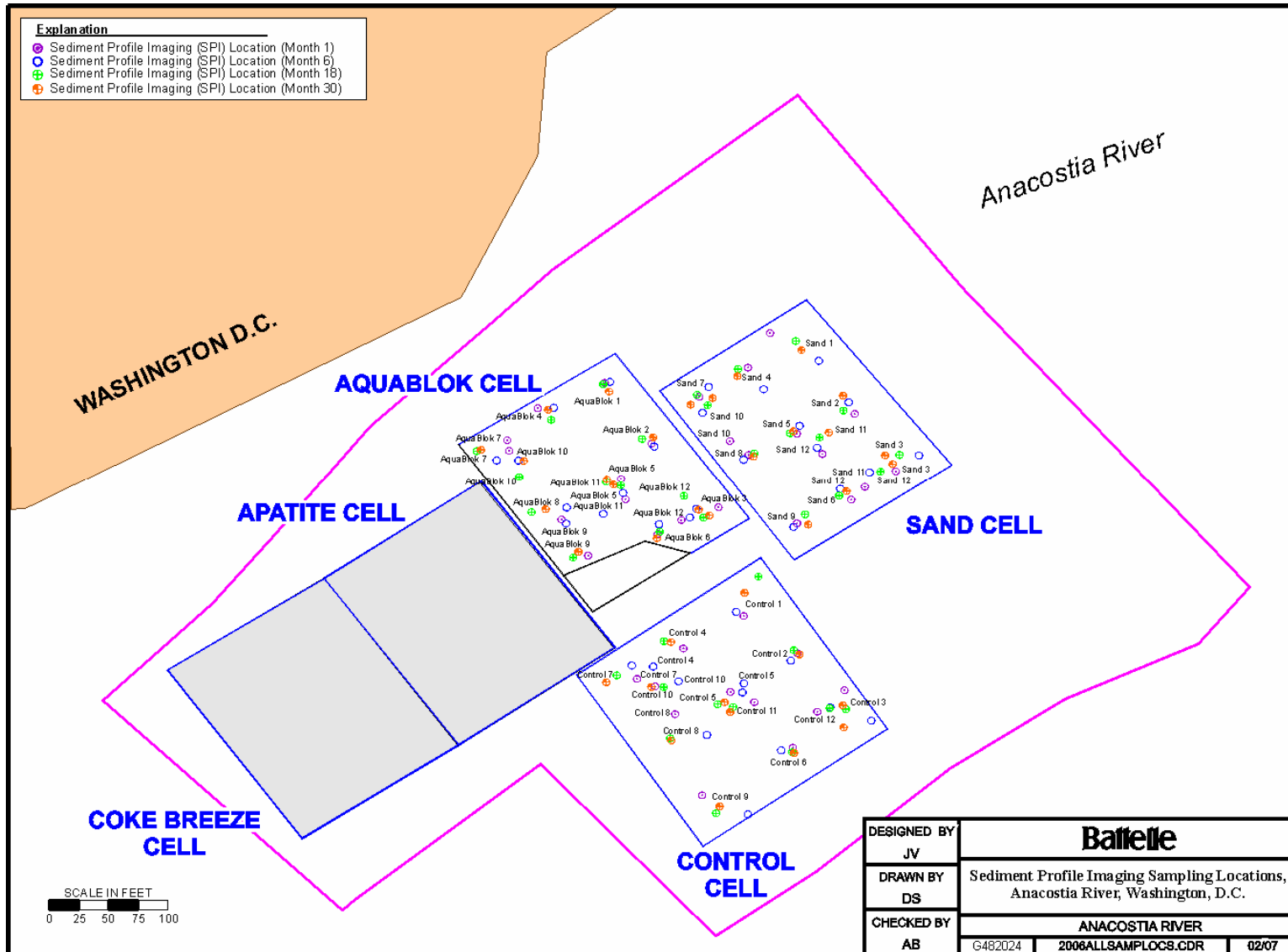

Figure 3-37. Sediment Profile Imaging Monitoring Locations

but do not provide any specific and unique information related to cap stability in the AquaBlok® or sand cells that was not gleaned from the bathymetry.

3.3.1.2 Objective #1 Results – Non-Critical Measurements

3.3.1.2.1 Sediment Profile Imaging. SPI surveys were conducted during the one-month, six-month, 18-month, and 30-month post-capping surveys, as described above in Section 3.2.4. During each survey, a total of 12 locations were evaluated using SPI in the AquaBlok®, sand, and control cells. Specifically, nine locations were assessed in each cell using the video SPI camera, and three locations in each cell were evaluated using the standard SPI camera. In addition, reference stations outside the control cell and either nearer or in the Anacostia River navigation channel were also assessed to provide further reference information for comparisons to the control and capped cells. Between the various surveys, individual SPI locations were generally replicated with a reasonable lateral offset to provide the most meaningful data comparisons between the sampling events. Figure 3-37 shows the SPI locations assessed during each sampling event. Accurate positional control of the SPI drops during each sampling event was achieved by operating the survey vessel in a very controlled fashion and by using a dGPS linked to accurate navigational software.

The SPI surveying provided several important results in the context of evaluating objective #1. The thickness of the sand layer over the AquaBlok® capping material remained generally consistent throughout the multiple surveys based on SPI attempts that achieved significant penetration, as did generally the grain size observed in the SPI images for the AquaBlok® cell. Similarly, the thickness of the sand cap in the sand cell and the grain size of this material remained generally consistent throughout the multiple surveys. In addition, the thicknesses observed of the various layers in the various cells were generally consistent with the design thicknesses and thicknesses derived from other measurement tools (e.g., bathymetric surveying).

The nature of the control sediments remained generally consistent throughout the demonstration, and the reference sediments outside the control cell towards the navigation channel were highly consistent throughout.

During the final SPI survey (i.e., 30-month post-capping), there appeared to be evidence that the surface sediments in both the AquaBlok® and sand cell had accumulated a greater proportion of fine-grained material, indicative of deposition of detritus and fine sediment. Also during the 30-month post-capping SPI survey, the control sediments appeared to demonstrate a change in surface texture, actually appearing to be more coarse-grained. This could have been related to new sediment deposition, but could also have been related to the movement of some sand capping/covering material from the demonstration area towards the navigation channel.

As indicated in Figure 3-38, depths of camera penetration were generally greatest in the control cell, and generally greater in the AquaBlok® cell compared to the sand cell. While it is intuitive that camera penetration depth would be greatest in the uncapped control cell, the reason for greater penetration rates in the AquaBlok® cell (which was covered with sand) relative to the sand cell is not readily explained. Overall penetration depths in the AquaBlok®, sand, and control cells generally declined throughout the course of the SPI surveys (see Figure 3-38), potentially indicative of grain sorting and “cementation” that would tend to inhibit physical penetration. Variations in penetration could also potentially be an artifact of even minor variations in the SPI equipment and/or equipment operation (e.g., specific manual efforts or camera weighting). The presence of and frequency of observation of biogenic and purely physical features in the surface and subsurface sediments throughout the demonstration area were generally highly consistent between the multiple SPI surveys. Such features were dominated by gas voids, but there were a limited number of biogenic structures (e.g., infauna tubes) also observed in the various surveys. There were no readily apparent differences in the presence of or frequency of observation of these features

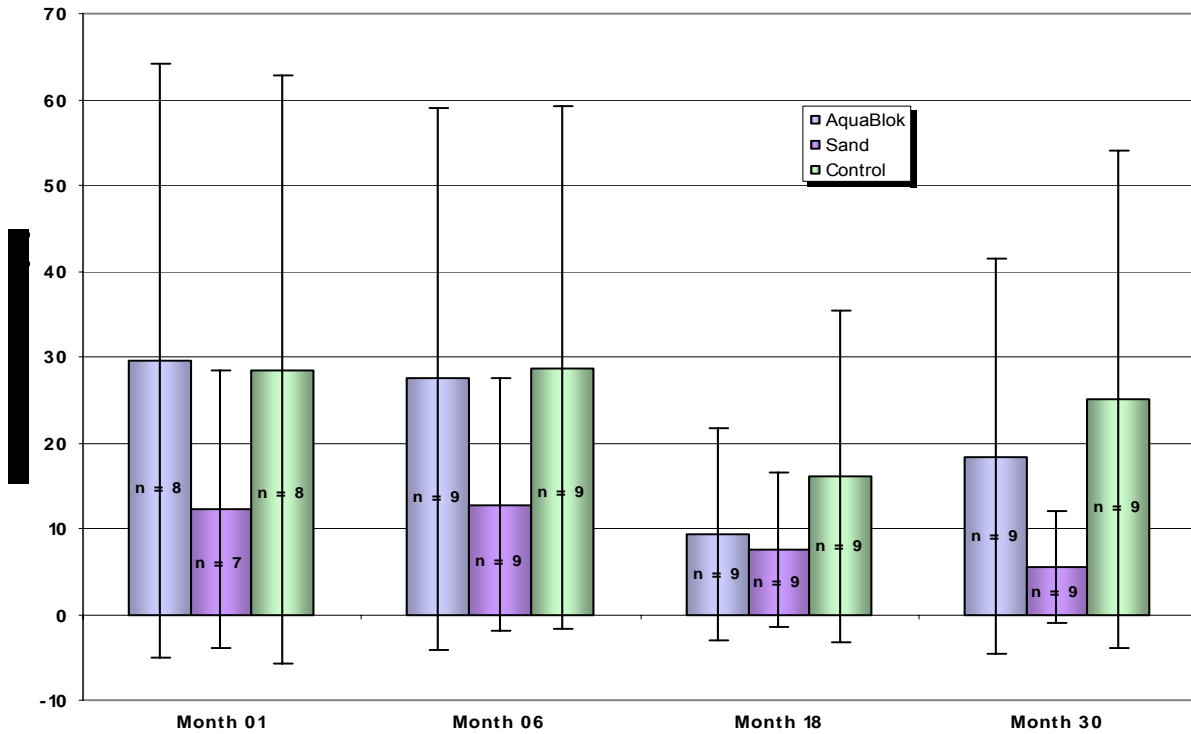

Figure 3-38. Video SPI Camera Penetration Trend (columns represent the mean, n is the population size, and error bars represent 95% upper and lower confidence intervals around the mean)

between the AquaBlok® and sand cells from a purely observational perspective.

Overall, the results of the SPI surveying conducted during the SITE demonstration indicate that both the sand and AquaBlok® caps remained intact and were therefore stable. In addition, the generally highly consistent grain size of the sediments in these cells throughout the multiple rounds of evaluation indicates that there was not a significant amount of bioturbation or other surface mixing that could have impacted cap integrity. While it appears that grain sorting could potentially have been responsible for declining penetration rates over time (i.e., through a cementing effect), this sorting does not appear to have been related to cap material loss or significantly obvious bioturbation. In fact, the SPI monitoring appears to demonstrate that fine detrital sediment accumulation occurred over the duration of the demonstration.

Appendix C provides additional detail related to the SPI surveys conducted during the AquaBlok® SITE demonstration as they relate to objective #1.

3.3.1.2.2 Gas Flux Analysis. Gas flux sampling was conducted during the 18-month and 30-month post-capping surveys, as described above in Section 3.2.4. During each survey, two chambers each were deployed in the AquaBlok®, sand, and control cells. Between the two surveys, individual flux chamber locations were generally replicated with a reasonable lateral offset to provide the most meaningful data comparisons between the sampling events. Figure 3-39 shows the flux chamber locations assessed during each sampling event. Accurate positional control was maintained during flux chamber deployment during each sampling event by operating the diving vessel in a very controlled fashion and by using a dGPS.

Table 3-4 presents information about all of the flux chambers that were deployed during the 18-month and 30-month post-capping field events. As indicated on this table, one flux chamber from each deployment period was not recovered (i.e., one chamber from the AquaBlok[®] cell during the 18-month post-capping event and one chamber from the sand cell during the 30-month post-capping event). These chambers may have been lost due to storm events. The fact that the missing AquaBlok[®] chamber during the 18-month post-capping event was found ashore supports this hypothesis. In addition, one flux chamber deployed in the AquaBlok[®] cell during the 30-month post-capping event was observed to be seated at an angle at the end of the month-long deployment period and the gas that was drawn from the chamber was only of very limited volume insufficient for laboratory analysis. Leaks were observed coming from two flux chambers at retrieval during the 18-month post-capping field event. One control cell chamber appeared to have a bad weld on the flux chamber dome that allowed gas to escape from the chamber. Although gas was recovered from this chamber and the scoped laboratory analyses were performed, the flux of gas into this chamber could not be accurately determined given this condition. In addition, some gas may have been lost during retrieval from one sand cell chamber while pulling the sample volume by syringe. Bubbles were observed coming from the syringe gasket during the draw-off of gas. The gasket was tightened after the leak was observed and the total losses were likely minimal.

The gases drawn from each of the flux chambers were analyzed for oxygen, nitrogen, methane, carbon dioxide, TNMOC, and 20 reduced sulfur compounds (see Table 3-5). In all cases, at least 98% of the gas by volume consisted of nitrogen, oxygen, and methane. The proportion of oxygen observed during both events ranged from 1% to 16%. In the 18-month post-capping event, the gas collected from the control cell exhibited the highest proportion of oxygen, and the gas from the sand cap the least. However, during the 30-month post-capping event, gas collected from both the sand cell and the control cell contained less than 3% oxygen. The proportion of methane observed during both events ranged from 24 to

80%. The lowest values were found in gas samples collected from the control cell during the 18-month post-capping event and the highest values were found in gas samples collected from the sand cell during the month-18 post-capping event and the control cell during the 30-month post-capping event. The proportion of carbon dioxide observed during both events ranged from 0.8% to 3%, with no apparent trends between cell or deployment event. Concentrations of TNMOC were generally higher during the 18-month post-capping event (220-780 parts per million by volume [ppmv]) compared to the 30-month post-capping event (24-91 ppmv). During the 18-month post-capping event, the control cell exhibited the lowest concentration of TNMOC in gas and the sand cap the highest with the AquaBlok[®] concentration in between.

Of the 20 reduced sulfur compounds that were analyzed, five were detected in gas collected from at least one flux chamber. Of these, only hydrogen sulfide was detected in the gas from every flux chamber sampled. In addition, only methyl mercaptan was detected at a level more than twice the detection limit (84 parts per billion by volume [ppbv]) in gas from the control cell during the 30-month post-capping event. Three reduced sulfur compounds were detected in gas collected from the AquaBlok[®] cell. Carbonyl sulfide and carbon disulfide were detected at low levels, comparable to gas samples collected from the sand and control cells. Hydrogen sulfide was present in much lower concentrations in gas collected from the AquaBlok[®] cell (10-11 ppbv) compared to levels measured in the flux chambers deployed in the sand and control cells (ranging from 290 to 18,000 ppbv).

Overall, all of the gases detected in samples from the AquaBlok[®] cell during the 18-month post-capping event were within the ranges observed for the sand and/or control cell with the exception of hydrogen sulfide, which was significantly lower for AquaBlok[®] compared to both the sand and control cell. It is possible that AquaBlok[®] retards hydrogen sulfide through a mechanism other than simple physical impermeability, such as sorption, but this potential phenomenon was not specifically assessed during the SITE demonstration. An analysis of the relative

presence of the various gases between AquaBlok® and the sand and control cells was not possible for the 30-month post-capping dataset because no gas could be collected from AquaBlok® during this event.

Table 3-6 shows the volumetric flux calculated for each gas detected in the sample from at least one chamber during any sampling event and a total flux based on the sum of these individual constituents. For constituents that were not detected, a volumetric flux rate was determined from detection limit data as a maximum possible flux (i.e., using the detection limit as an upper bound on the potential flux).

Volumetric flux was determined by the following equation:

$$\text{Flux} = \frac{V}{A \cdot T} \quad (3-6)$$

Where: V = volume of gas accumulated during the flux chamber deployment (milliliters [mL])

A = cross-sectional area of the flux chamber (m²)

T = duration the flux chamber was deployed (days)

The volume of gas collected from the flux chambers ranged from 160-10,800 mL during the sampling events, and the deployment time for each flux chamber ranged from 29 to 32 days (see Table 3-4). The diameter of each flux chamber was estimated to be 22.5 in (i.e., equivalent to the standard diameter of a 55-gal drum). Accordingly, the cross-sectional area of the flux chambers was estimated as 397.6 in² or 0.2565 m² (using the equation area = πr²). Volumetric flux during the SITE demonstration ranged from 21 to 1,453 mL/m²-d (see Table 3-6).

No flux of gases was observed at AquaBlok® chamber 1 during the 30-month post-capping event, and an insufficient volume of gas was recovered from the second AquaBlok® chamber during this event for analysis. This could be taken to suggest that the AquaBlok® was acting as an impermeable barrier and preventing the direct flux of gases from sediment to overlying

water. However, gas was recovered from the one chamber sampled in the AquaBlok® cell during the 18-month post-capping event, which could suggest that there may have been active ebullition through the AquaBlok® barrier at that time releasing gases that collected beneath the cap.

Table 3-6 also presents the mass based flux for the detected compounds. To achieve this, the volumetric flux was converted from mL/m²-d to m³/m²-d by applying a factor of 1/1,000,000 (i.e., 1,000,000 mL = 1 m³). The Ideal Gas Law was then used to convert the volume based flux (m³/m²-d) to flux based on moles (mol) of gas (mol/m²-d). This was done by taking the Ideal Gas Law equation PV=nRT and rearranging as follows:

$$\frac{n}{V} = \frac{P}{RT} \quad (3-7)$$

where: n = mol
V = volume
P = standard pressure (1 atmosphere [atm])
R = universal gas constant
T = standard temperature (25 degrees Celsius [°C])

This equation could then be solved for the moles of a particular compound, and then the mass flux of the collected gas converted from volumetric flux using the following equation:

$$\frac{40.87 X \text{ mol}}{\text{m}^2 \cdot \text{d}} = \frac{40.87 \text{ mol}}{\text{m}^3} \times \frac{X \text{ m}^3}{\text{m}^2 \cdot \text{d}} \quad (3-8)$$

Where: X = the magnitude of the volumetric flux after conversion from mL to m³

Finally, the rate of gas production (mol/m²-d) was multiplied by the molar mass of the compound (mg/mol) and the concentration of the compound (unitless; expressed as a fraction of the whole), which were initially presented in a variety of units, such as %, ppmv, and ppbv, for various compounds. For non-detected compounds, a mass flux was not calculated. In addition, a mass

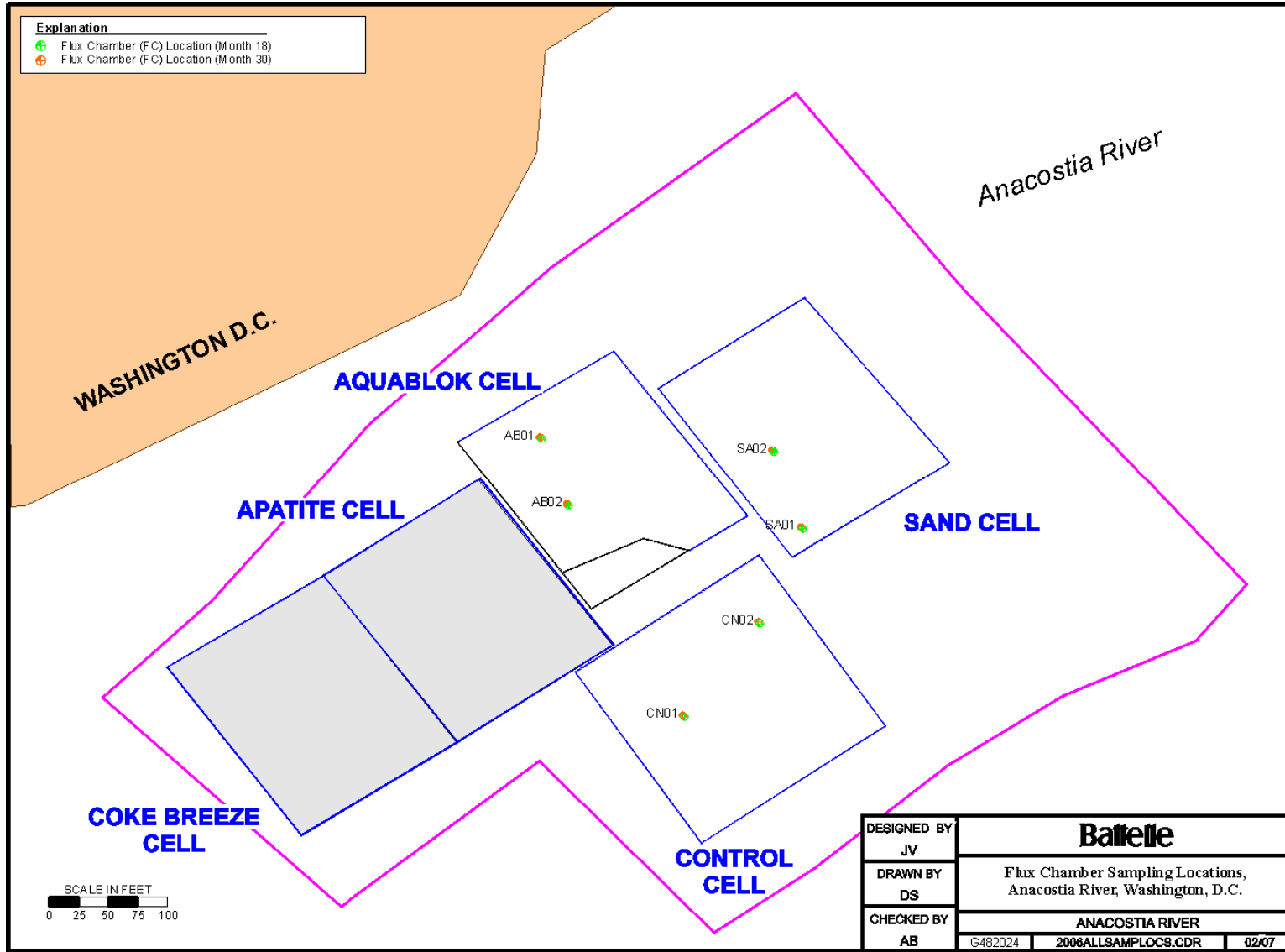

Figure 3-39. Gas Flux Monitoring Locations

Table 3-4. SITE Demonstration Gas Flux Sampling Observations

Field Event	Cell	Flux Chamber	Deployment Duration (days)	Recovered Gas Volume (mL)	Total Flux (mL/m ² -d)
18-Month Post-Capping	AquaBlok [®]	AB01	32	2,500	303
		AB02	N/A ^(a)	--	--
	Sand	SA01	32	1,400 ^(b)	170
		SA02	32	2,000	242
	Control	CN01	32	3,500	425
CN02		32	1,800	N/A ^(c)	
30-Month Post-Capping	AquaBlok [®]	AB01	29	0	0
		AB02	29	160 ^(d)	21
	Sand	SA01	29	600	81
		SA02	N/A ^(a)	--	--
	Control	CN01	29	1,100	147 ^(e)
CN02		29	10,800	1,453	

(a) Chamber not recovered; no sampling possible.

(b) Potential minimal loss of gas through leaking syringe.

(c) Flux could not be determined accurately due to significantly leaking chamber.

(d) Insufficient volume of gas to perform laboratory analyses.

(e) Potentially bad weld on chamber, but flux still calculable.

flux for TNMOC and an overall total mass flux were not calculated, as these would be of very limited usefulness in understanding the data.

The gas fluxes from native sediment observed during the SITE demonstration were generally comparable to those found in the available literature. Volumetric methane fluxes from sediments have been observed at other sites ranging from 0.3 to 2,640 mL/m²-day (Yuan, 2007 and references therein). In addition, methane flux has previously been reported from Anacostia River sediment in the laboratory as a function of temperature, yielding 0, 341, and 917 mL/m²-day at 4, 22, and 35 °C, respectively (Yuan, 2007 and references therein). By comparison, the fluxes observed from the uncapped control cell ranged from approximately 150 to 1,450 mL/m²-day. Water temperatures during the 18-month and 30-month post-capping events were generally approximately 26 °C.

Overall, it would generally appear that gas ebullition was least pronounced in the AquaBlok[®] cell, in particular on the basis of the lack of accumulated gas to sample during the 30-month post-capping event. However, the gas sample that was collected from the AquaBlok[®] cell during the 18-month post-capping event exhibited

generally similar concentrations and volumetric and mass fluxes compared to the sand and control cells. In this sample, hydrogen sulfide was present at a significantly lower concentration and exhibited significantly lower constituent-specific volumetric and mass flux than in the sand and control cells, indicating that AquaBlok[®] could potentially have some specific retardation effect on this compound. In general, the gas flux data do not indicate that a sand cap alone has a significant impact on gas ebullition. On the basis of the data generated, it could be concluded that AquaBlok[®] is more stable than sand in terms of preventing gas migration. Alternatively, given its high degree of impermeability, AquaBlok[®] could

be susceptible to a buildup of gases under the cap and episodic releases of this built up gas if enough pressure were generated. While this phenomenon was not directly observed, it could explain the ability to collect a gas sample from the AquaBlok[®] cell during the 18-month post-capping event (and potentially the loss of one chamber during this same event).

Clear interpretation of the gas flux data from the SITE demonstration is complicated by the loss of certain chambers and the potential for other sampling issues. These issues also prevented a robust statistical analysis of the data to ascertain

Table 3-5. SITE Demonstration Gas Flux Sampling Results

Analysis	Detection Limit and Units	AquaBlok® Cell		Sand Cell				Control Cell					
		AB01 Month 18	AB01 Month 18 Duplicate	SA01 Month 18	SA01 Month 18 Duplicate	SA01 Month 30	SA02 Month 18	CN01 Month 18	CN01 Month 30	CN02 Month 18	CN02 Month 18 Duplicate	CN02 Month 30	
General Gases	TNMOC	50 ppmv	630	NA	780	NA	24.0	410	420	80.9	220	220	91.4
	Oxygen	0.10%	8.3	NA	1.2	NA	2.59	5.0	12	1.22	16	16	1.58
	Nitrogen	0.10%	38	NA	20	NA	44.9	38	46	18.7	58	58	21.9
	Methane	0.10%	55	NA	78	NA	50.9	57	40	78.3	24	25	75.7
	Carbon Dioxide	0.10%	0.81	NA	3.0	NA	1.65	1.8	1.2	1.74	0.91	0.90	0.81
Reduced Sulfur Compounds	Hydrogen Sulfide	4 ppbv	10	11	18,000	18,000	7,000	12,000	840	2200	290	NA	11000
	Carbonyl Sulfide	4 ppbv	15	17	<300	<400	<40	<200	18	16	19	NA	<100
	Methyl Mercaptan	4 ppbv	<10	<10	<300	<400	<40	<200	<10	84	<10	NA	<100
	Ethyl Mercaptan	4 ppbv	<10	<10	<300	<400	<40	<200	<10	<12	<10	NA	<100
	Dimethyl Sulfide	4 ppbv	<10	<10	<300	<400	<40	<200	<10	19	<10	NA	<100
	Carbon Disulfide	4 ppbv	14	17	<300	<400	<40	<200	18	<12	12	NA	<100
	Isopropyl Mercaptan	4 ppbv	<10	<10	<300	<400	<40	<200	<10	<12	<10	NA	<100
	tert-Butyl Mercaptan	4 ppbv	<10	<10	<300	<400	<40	<200	<10	<12	<10	NA	<100
	n-Propyl Mercaptan	4 ppbv	<10	<10	<300	<400	<40	<200	<10	<12	<10	NA	<100
	Ethyl Methyl Sulfide	4 ppbv	<10	<10	<300	<400	<40	<200	<10	<12	<10	NA	<100
	Thiopene	4 ppbv	<10	<10	<300	<400	<40	<200	<10	<12	<10	NA	<100
	Isobutyl Mercaptan	4 ppbv	<10	<10	<300	<400	<40	<200	<10	<12	<10	NA	<100
	Diethyl Sulfide	4 ppbv	<10	<10	<300	<400	<40	<200	<10	<12	<10	NA	<100
	n-Butyl Mercaptan	4 ppbv	<10	<10	<300	<400	<40	<200	<10	<12	<10	NA	<100
	Dimethyl Disulfide	4 ppbv	<10	<10	<300	<400	<40	<200	<10	<12	<10	NA	<100
	3-Methylthiophene	4 ppbv	<10	<10	<300	<400	<40	<200	<10	<12	<10	NA	<100
	Tetrahydrothiophene	4 ppbv	<10	<10	<300	<400	<40	<200	<10	<12	<10	NA	<100
	2-Ethylthiophene	4 ppbv	<10	<10	<300	<400	<40	<200	<10	<12	<10	NA	<100
	2,5-Dimethylthiophene	4 ppbv	<10	<10	<300	<400	<40	<200	<10	<12	<10	NA	<100
	Diethyl Disulfide	4 ppbv	<10	<10	<300	<400	<40	<200	<10	<12	<10	NA	<100

temporal, spatial, or inter-cell trends. Specifically, potential disruption of the seal between flux chambers and the sediment they were keyed into was observed in certain cases. It is, therefore, not certain that the integrity of the chamber seals was maintained for the entire duration of the chamber deployments. If the chamber seal for the AquaBlok® sample collected during the 18-month post-capping event was compromised, it is possible that gas may have flowed into the flux chamber via lateral transport (i.e., short-circuiting) rather than through the AquaBlok®. Furthermore, it is unlikely that the gas flux assessment captured all potential gas movement over the cap areas, given that the flux chambers were located in small isolated regions that could not have captured ebullition cap-wide. As such, while a quantitative interpretation of the gas flux data is provided herein, these data should be evaluated in the context of the uncertainties associated. Specifically, while the data suggest that ebullition did occur, the quantitative analysis should not be taken to suggest that the gas flux evaluation was able to quantify the duration, volume, or concentration of all vapor flux.

Also, conceptually, a cap installed over contaminated sediment would tend to eliminate the accumulation of new organic-rich sediment on the contaminated sediment surface. Accordingly, it is likely that over time, the rate of biogenic gas production in the contaminated sediment interval would decrease. In addition, a cap could conceivably be designed to specifically integrate active or passive venting of biogenic gas.

3.3.1.2.3 Sediment Coring and Analysis of Physical Parameters. Sediment coring and analysis of physical parameters was conducted during the six-month, 18-month, and 30-month post-capping surveys, as described above in Section 3.2.4 and in direct conjunction with the sediment coring described in Section 3.3.1.1.2.

As indicated in Section 3.2.4, all sediment core samples were analyzed for TOC, PSD, and moisture content. In addition, duplicate samples were collected as appropriate and analyzed for either this same set of parameters or a subset thereof. The data generated from the analysis of

the sediment samples collected during the various sediment coring events are summarized in tabular form for all individual analyses in Appendix H. In addition, graphs are provided in Appendix H that show the average PSD throughout the vertical profile of the cores sampled from each cell. The PSD results were averaged given the high degree of consistency between sampling events. The PSD graphs are grouped by sampling event and then by cell within each sampling event.

As indicated in the PSD graphs in Appendix H, sediment in the control cell was dominated by silts and clays, with a decreasing amount of sand with depth. A trace to small amount of gravel was observed at the surface of the native sediments in some cases. In the sand cell, sample intervals in the sand capping layer were generally nearly 100% sand with trace to small contributions of silt/clay and gravel. In the interface between the sand capping layer and native sediment, the sample was dominated by sand with an increasing amount of silt and clay, and in the upper native sediment layer, the sample was generally predominantly silt and clay with only some sand. For the AquaBlok® cell, the sand covering layer was generally nearly 100% sand with trace to small contributions of silt/clay and gravel, consistent with the sand capped cell. In the interface between the sand layer and AquaBlok®, the amount of gravel increased, and in the AquaBlok® layer itself, the sample intervals were highly dominated by the gravel and silt/clay fractions. In the interface between AquaBlok® and native sediments, the proportion of gravel generally declined along with an increase in silt/clay content. In the upper native sediment layer, the sample was generally predominantly silt and clay with only some sand and trace gravel, consistent with the other cells. These observations are consistent with all other observations of the sediment type in the various cells (i.e., SPI and visual assessment of core logs) as well as information related to the actual composition of the various materials used during capping (i.e., AquaBlok® is a clay material with a gravel core).

Figure 3-40 provides a comprehensive graphical summary of the average TOC concentration

Table 3-6. Calculated Volumetric and Mass Gas Flux for Individual Compounds

Compound	AquaBlok® Cell		Sand Cell			Control Cell		
	AB01		SA01		SA02	CN01		CN02
	Month 18	Month 30 ^(a)	Month 18	Month 30	Month 18	Month 18	Month 30	Month 30
TNMOC	0.2 (N/A)	N/A (N/A)	0.1 (N/A)	1.9E-3 (N/A)	0.1 (N/A)	0.2 (N/A)	1.2E-2 (N/A)	0.1 (N/A)
Oxygen	25 (33)	N/A (N/A)	2.0 (2.7)	2.1 (2.7)	12 (16)	51 (67)	1.8 (2.4)	23 (30)
Nitrogen	115 (132)	N/A (N/A)	34 (39)	36 (42)	92 (105)	195 (224)	28 (32)	318 (364)
Methane	167 (109)	N/A (N/A)	132 (87)	41 (27)	138 (91)	170 (111)	115 (76)	1,100 (721)
Carbon Dioxide	2.0 (4.4)	N/A (N/A)	5.1 (9.2)	1.3 (2.4)	4.4 (7.8)	5.1 (9.2)	2.6 (4.6)	12 (21)
Hydrogen Sulfide	3.0E-6 (4.2E-6)	N/A (N/A)	3.1E-3 (4.3E-3)	5.7E-4 (7.9E-4)	2.9E-3 (4.0E-3)	3.6E-4 (5.0E-4)	3.2E-4 (4.5E-4)	1.6E-2 (2.2E-2)
Carbonyl Sulfide	4.5E-6 (1.1E-5)	N/A (N/A)	<5.1E-5 (N/A)	<3.2E-6 (N/A)	<4.8E-5 (N/A)	7.6E-6 (1.9E-5)	2.4E-6 (5.8E-6)	<1.5E-4 (N/A)
Methyl Mercaptan	<3.0E-6 (N/A)	N/A (N/A)	<5.1E-5 (N/A)	<3.2E-6 (N/A)	<4.8E-5 (N/A)	<4.3E-6 (N/A)	1.2E-5 (2.4E-5)	<1.5E-4 (N/A)
Dimethyl Sulfide	<3.0E-6 (N/A)	N/A (N/A)	<5.1E-5 (N/A)	<3.2E-6 (N/A)	<4.8E-5 (N/A)	<4.3E-6 (N/A)	2.8E-6 (7.1E-6)	<1.5E-4 (N/A)
Carbon Disulfide	4.2E-6 (1.3E-5)	N/A (N/A)	<5.1E-5 (N/A)	<3.2E-6 (N/A)	<4.8E-5 (N/A)	7.6E-6 (2.4E-5)	<1.8E-6 (N/A)	<1.5E-4 (N/A)
TOTAL	303 (N/A)	N/A (N/A)	170 (N/A)	81 (N/A)	242 (N/A)	425 (N/A)	147 (N/A)	1,453 (N/A)

Volumetric flux precedes mass flux in parentheses

Units for volumetric flux = mL/m²-day

Units for mass flux = mg/m²-day

(a) No gas recovered from chamber

N/A = not applicable (because of sampling issue or calculation is not appropriate)

detected throughout the vertical profile of the cores collected from each cell during each sampling event. For the AquaBlok® cell, intervals AB1 through AB3 represent samples of the sand covering layer, intervals AB5 through AB7 represent samples from the AquaBlok® material, and interval AB9 represents the upper horizon of native sediment, while interval AB4 represents the interface between the sand covering layer and AquaBlok® material and AB8 represents the interface between AquaBlok® material and native sediment. In the sand cell, intervals SO1 through SO4 represent sand capping material, interval SO5 represents the interface between sand and native sediment, and interval SO6 represents the upper horizon of the native sediment. For the control cell, all intervals are obviously native sediment.

As indicated on Figure 3-40, in the control cell, TOC content was generally quite high for all events and throughout the upper 9 cm of the native sediments. The range of TOC was generally between 6 and 12%, and declined with depth in the upper 9 cm. This is generally consistent with the likely deposition of new organic detrital material at the surface and a limited degree of subsurface mixing through biogenic activity in addition to biogenic consumption of organic material in the deeper surface layers. The differences in TOC content between events could be related to differences in the deposition of new organic-rich sediment. For instance, TOC at the surface of the control cell appears to have declined in the 18-month post-capping monitoring period, which could be attributed to high river flow events that may have

deposited relatively disproportionately inorganic material rather than fine detrital material.

In the sand cell, TOC concentrations were generally very low in the sand layer, and increased with depth in the interface between sand and native sediments. In the basal sampling interval in the sand cell (i.e., the upper native sediment horizon), TOC levels were consistent with the native sediment material sampled in the control cell. TOC levels were slightly higher at the surface of the sand capping layer than in the rest of the sand layer, but there was no indication of significant vertical mixing at the surface. These results are consistent with the profile of the sand cell and the likely deposition of new, more organic-rich sediment at the surface than the relatively organically-inert sand used during cap construction.

In the AquaBlok® cell, the TOC trend in the sand covering layer was highly consistent with the sand cap in the sand cell, and the TOC trend between AquaBlok® and the native sediment was generally consistent with the trend between sand and native sediment in the sand cell. In the AquaBlok® material itself, TOC concentrations were generally higher than in the sand cover layer or the sand capping cell in the month 6 and month 18 data, ranging generally between 2 and 6%. In the month 30 data, levels of TOC in the AquaBlok® cell were generally very low and consistent with the inert sand covering layer. Given that typical, unamended AquaBlok® is low in organic content, it would appear that the month 6 and month 18 data were influenced potentially by the entrainment of organic-rich native sediment in certain samples. Alternatively, the presence of higher levels of TOC in the AquaBlok® material during the month 6 and month 18 events could have been real and then depleted by month 30.

Overall, the physical data generated through sediment coring during the demonstration confirm the physical stability of the sand and AquaBlok® caps and corroborate other lines of evidence (i.e., SPI and oceanographic surveying) that indicate the same. Moreover, the results from the physical dataset appear to suggest that AquaBlok® may have a greater sorption capacity

relative to sand given its greater proportion of clay/silt and higher TOC content than generally organically-inert sand (i.e., clay material and organic carbon are capable of retarding organic and inorganic contaminants through sorption mechanisms).

3.3.2 Objective #2 – Ability of An AquaBlok® Cap to Control Groundwater Seepage

Tidal forces, regional pumping, or other hydrogeologic phenomena in surface water bodies have the potential to impose significant vertical groundwater gradients into or out of bottom sediments. One of the primary advantages of AquaBlok® is that it is claimed to significantly reduce permeability, which would be reflected as a reduction in groundwater seepage flows relative to seepage in sand-capped sediments and uncapped control areas.

To evaluate the ability of AquaBlok® to control groundwater seepage relative to sand and native sediments, the following critical and non-critical measurements were identified and assessed through data collection during the various SITE demonstration sampling events.

Critical Measurements

- Sediment coring and analysis of hydraulic conductivity; and
- Seepage meter testing

Non-critical Measurements

- None

3.3.2.1 Objective #2 Results – Critical Measurements

3.3.2.1.1 Sediment Coring and Analysis of Hydraulic Conductivity.

Sediment coring and analysis of hydraulic conductivity was conducted during the 18-month and 30-month post-capping surveys, as described above in Section 3.2.4 and in direct conjunction with the sediment coring described in Section 3.3.1.1.2. During each coring event, two individual cores each were collected from two of

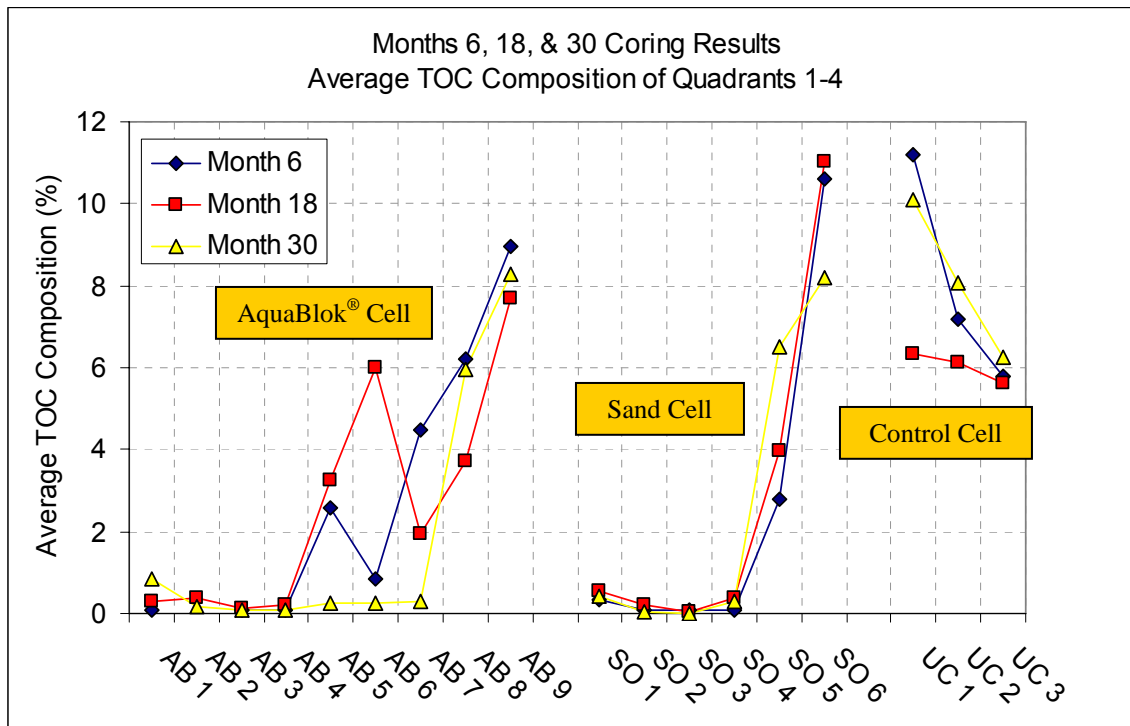

Figure 3-40. Average TOC Concentration in Demonstration Area During SITE Demonstration (x-axis represents vertical core profile from shallowest at left to deepest at right)

the four quadrants in the AquaBlok®, sand, and control cells. Figure 3-22 displays the hydraulic conductivity sediment coring locations from each of the sampling events. As indicated on Figure 3-22, some of the hydraulic conductivity sediment cores intended to target the control cell were collected outside the determined boundary of the control cell. This occurred presumably because of a misinterpretation of navigational position by the coring contractor. However, given that these cores were collected in identical native sediment material as that within control cell, this does not in any way compromise data usability or representativeness. In addition, during the 30-month post-capping hydraulic conductivity evaluation, both conductivity cores from the sand cell were collected from the same quadrant.

However, given that these cores both yielded the appropriate interval of interest for analysis (i.e., the sand cap), this also does not affect the demonstration results.

As indicated in Section 3.2.4, hydraulic conductivity cores were preserved intact and

analyzed at the laboratory for hydraulic conductivity. Table 3-7 summarizes the hydraulic conductivity data generated in the AquaBlok®, sand, and control cells. As indicated in Table 3-7, the hydraulic conductivity of the native sediment material during both events was very low, on the order of 10^{-8} cm/s. The low conductivity in the native material is likely attributable to the cohesive, fine-grained nature of the sediment. The hydraulic conductivity of the AquaBlok® material during both events (i.e., 10^{-7} to 10^{-8} cm/s) was very similar to the range of values determined for the native sediment and consistent with the documented range for this capping material (see Section 2.1). Hydraulic conductivities in the range determined for AquaBlok® (and native sediment in the demonstration area) are indicative of a highly impermeable material. Alternatively, the calculated hydraulic conductivity for the sand capping material from the sand cell (i.e., 10^{-3} to 10^{-4} cm/s), while it did demonstrate some decrease between the 18-month and 30-month post-capping events, was several orders of magnitude greater than AquaBlok®.

The hydraulic conductivity data generated during the demonstration clearly indicate that AquaBlok[®] is significantly less permeable than sand and therefore likely to be characterized by far less fluid flow and the potential for contaminant movement in this fluid flow compared to the more traditional sand capping material. Moreover, while the AquaBlok[®] material demonstrated similar conductivity when compared to native sediments, it is likely that AquaBlok[®] would have a lower intrinsic permeability given the greater potential for preferential flow paths to develop in native sediments from biogenic activity.

The results of the hydraulic conductivity testing conducted during the SITE demonstration raise an important question. Specifically, the data suggest that certain native sediments might be equally effective in terms of impermeability compared to AquaBlok[®]. During any sediment capping remedial design, a designer would certainly want to evaluate all potential sources of capping material to identify one with the greatest probability of meeting performance objectives and minimal cost.

3.3.2.1.2 Seepage Meter Testing.

Seepage meter testing was conducted during the one-month, six-month, 18-month, and 30-month post-capping surveys, as described above in Section 3.2.4. Each seepage meter event was conducted by deploying at least two ultrasonic flux meters in the AquaBlok[®], sand, and control cells and collecting flux data from the meters for a few to several days. The meters were deployed and retrieved by divers, and accurate positional control during seepage meter deployments was achieved by using a GPS. Locations of the submerged meters are provided on Figure 3-41. Relevant meter location information, including monitoring problems associated with each seepage meter testing event, is described below.

Month 1

One meter location in the control cell during the one-month post-capping seepage meter testing event was moved during the deployment period (i.e., from location ANA5-1 to location ANA5-2;

see Figure 3-41) due to significant data instability presumably from gas ebullition.

Month 6

One AquaBlok[®] cell meter during the six-month post-capping event was located improperly (i.e., in the portion of this capping cell that was inadequately covered during construction). This meter was moved as appropriate (i.e., from location AQB1 to location AQB3; see Figure 3-41) so that representative data could be gathered. In addition, one meter location in the control cell during the six-month post-capping seepage meter testing event was moved during the deployment period (i.e., from location CS1 to location CS3; see Figure 3-41) due to significant data instability presumably from gas ebullition.

Month 18

No meters required repositioning during the 18-month post-capping seepage meter testing event.

Month 30

One AquaBlok[®] cell meter during the 30-month post-capping event was moved during the deployment period (i.e., from location AQB2 to location AQB3; see Figure 3-41) based on data variability that suggested the AquaBlok[®] cap may have been compromised at the original location, potentially by other sampling methods (e.g., coring).

Once the data from each meter were uploaded, a representative 24-hour tidal cycle from at least one meter location per cell was selected to calculate a range of and average specific discharge rate. The specific meter locations relied on to perform these calculations were as follows (see Figure 3-41):

Month 1

A representative 24-hour tidal cycle was selected for location ANA1 in the AquaBlok[®] cell, location ANA4 in the sand cell, and location ANA6 in the control cell. These locations were selected as they tended to exhibit less impact from gas

Table 3-7. SITE Demonstration Hydraulic Conductivity Results

Cap Cell	Material	Sampling Event	Quadrant	Hydraulic Conductivity (cm/s)
AquaBlok®	AquaBlok®	18-month Post-capping	NE	1.7E-8
			SE	1.7E-7
		30-month Post-capping	NE	4.1E-8
			NW	7.7E-8
Control	Native Sediment	18-month Post-capping	SW	6.6E-8
			outside cell	5.8E-8
		30-month Post-capping	SW	1.4E-8
			outside cell	8.7E-8
Sand	Sand	18-month Post-capping	NW	5.7E-3
			NE	8.3E-3
		30-month Post-capping	NW	2.9E-4
			NW	1.7E-4

ebullition compared to the other meter in each cell.

Month 6

A representative 24-hour tidal cycle was selected for both properly located meters in the AquaBlok® cell (i.e., AQB2 and AQB3) and both locations in the control cell (i.e., CS1 and CS2). A representative 24-hour tidal cycle was selected for location SC2 in the sand cell, while the other sand cell meter experienced data instability related to gas ebullition. A 24-hour tidal cycle was also used to complete calculations for the improperly located AquaBlok® cell meter (i.e., AQB1) to provide reference.

Month 18

A representative 24-hour tidal cycle was selected for both meters in the AquaBlok® cell (i.e., AQB1 and AQB2) and both locations in the sand cell (i.e., SC1 and SC2). A representative 24-hour tidal cycle was selected for location CS2 in the control cell, while the other control cell meter experienced a cable failure.

Month 30

A representative 24-hour tidal cycle was selected for both locations in the sand cell (i.e., SC1 and SC2) and both locations in the control cell (i.e., CS1 and CS2). A representative 24-hour tidal cycle was selected for location AQB1 in the

AquaBlok® cell, but location AQB3 did not yield a full 24-hour dataset. A 24-hour tidal cycle was also used to complete calculations for the potentially improperly located AquaBlok® cell meter (i.e., AQB2) to provide reference.

Table 3-8 summarizes the calculated discharge rates for the various meters deployed in the AquaBlok®, sand, and control cells during the SITE demonstration. As indicated in this table, for each sampling event, the mean, minimum, and maximum calculated discharge rates over the representative 24-hour tidal period were generally lowest for the seepage meters deployed in the AquaBlok® cell. In addition, the mean discharge rate measured in the meters deployed in the AquaBlok® cell tended to be negative, indicating an average flux from surface water into the sediment as opposed to from the sediment to the overlying water column. For the most part, discharge measured in the control cell was low but on average positive, indicating a typically net flux from the sediment to surface water in the native sediments. However, variability from event to event tended to be greatest in the control cell, which is not unexpected given tidal variability and the realistic expectation that native sediments would be least effective at dampening tidal impacts on seepage. Calculated discharge rates in the sand cell were generally higher than in the AquaBlok® cell and the control cell, suggesting the most significant vertical movement of fluid from sediment to surface water in this cell. It is not clear if there is

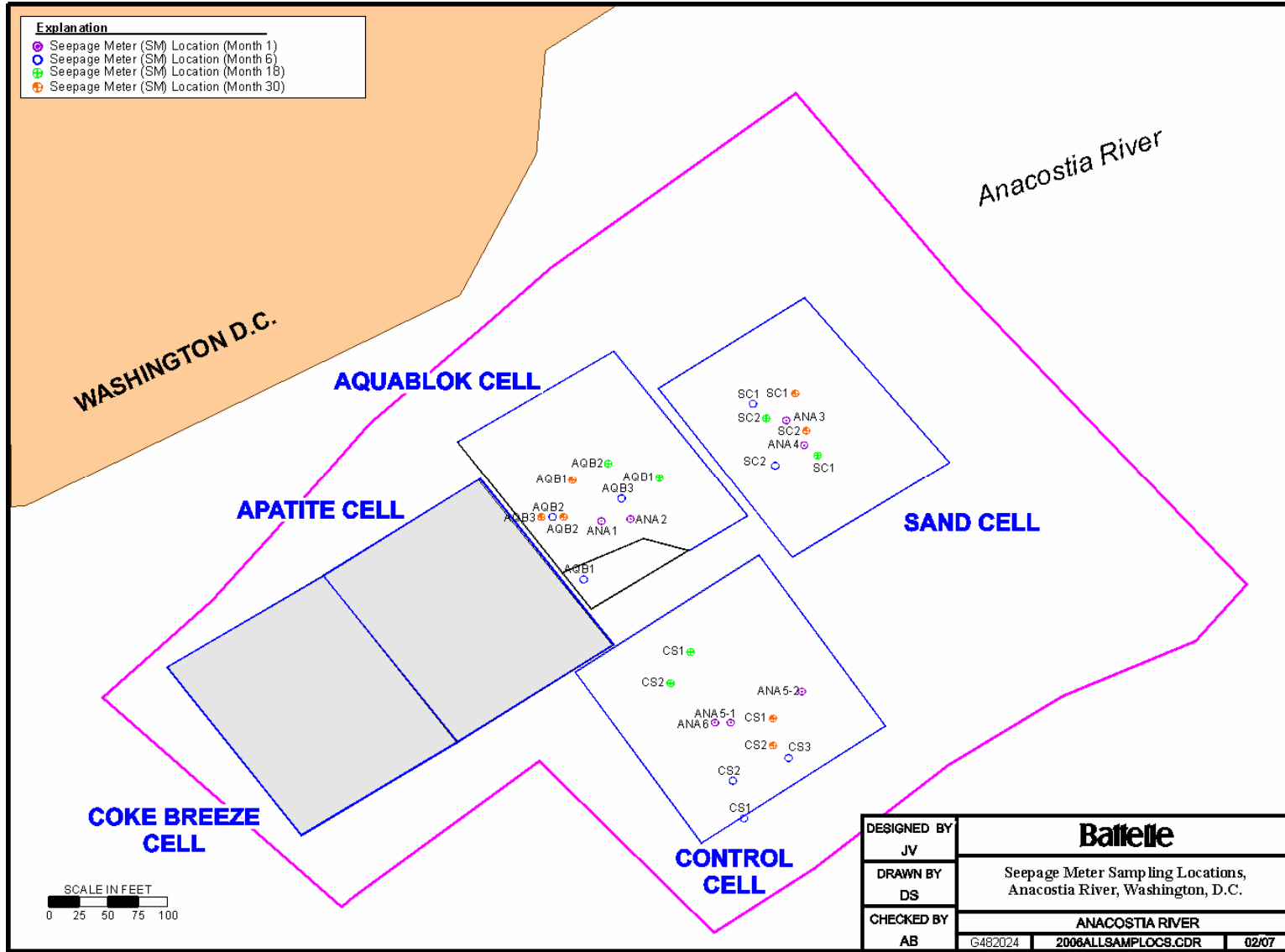

Figure 3-41. Seepage Meter Monitoring Locations

a mechanism, such as hydrostatic pressure buildup coupled with the permeable nature of sand, that could be responsible for exacerbating upward fluid flow in the sand cell. Alternatively, it is possible that increased upward fluid flow in the sand cap cell could have resulted from the diversion of flow under the AquaBlok® cap towards the adjacent sand cell. However, neither of these specific potential phenomena were assessed through the SITE demonstration.

Table 3-8 also suggests that the magnitude of the difference in seepage between the AquaBlok® cell and the sand and control cells was generally less pronounced beyond the one-month post-capping event. The reason for this apparent trend is not known, but could be associated with the increasing effects of gas ebullition beneath the cap cells, or alternatively, with the incremental increase in insults to the caps through invasive sampling, which could have had the most pronounced effect in the AquaBlok® cell by mitigating the ability of the clay cap to control fluid flow. Specifically, successively more cores that penetrated the AquaBlok® cell could have generated sand-filled channels as these voids were then filled with the sand covering material. Subsequently, seepage meters could have been located at or near such locations where the potential seepage control of AquaBlok® would have been compromised.

During each sampling event, an empirical harmonic analysis was also completed on the data to determine the relative variability in discharge compared to tidal phase. These analyses generally indicated that the AquaBlok® capping material was more effective at dampening tidal influences on flux relative to the sand capping material (i.e., the sand cell), and also that the lag in flux induced by tidal phase was shortest for the sand cell even compared to the control cell sediments. It is not clear if there is a mechanism, such as hydrostatic pressure induced gradients, that could be responsible for lessening tidal lag effects in the sand cell, and no specific assessment was completed to resolve this question.

Figure 3-42 shows the measured specific discharge rates in the various cells, along with

the tidal phase and harmonic analyses for the one-month post-capping seepage meter dataset, and demonstrates the lower discharge through AquaBlok® as well as the dampening effect of AquaBlok® on tidal phase. Figures 3-43 through 3-45 show the same for the 30-month post-capping data (graphed separately for each individual cell). Appendix D provides additional detail related to the individual seepage meter testing events and application of the harmonic analyses, including the rationale and methods for the harmonic assessment.

In addition to the general evaluation of discharge rates calculated during the SITE demonstration, detailed statistical analysis was conducted for the specific discharge measured through the AquaBlok®, sand, and control cells to determine whether there were any statistically significant differences in seepage through the caps. The statistical analysis was performed by fitting a series of statistical models to the specific discharge data. The data used for the statistical analysis were the same 24-hour tidal cycle data selected for each appropriate meter in each cell to derive the general summary calculations described above. The statistical models were of increasing complexity to adjust for several ancillary variables that could have affected the measured specific discharge. The fitted models are best expressed as:

$$D_{ijt} = \mu + C_i + L_{j(i)} + \varepsilon_{ijt} \quad (3-9)$$

$$D_{ijt} = \mu + C_i + L_{j(i)} + \beta T_{t-\theta} + \varepsilon_{ijt} \quad (3-10)$$

$$D_{ijt} = \mu + C_i + L_{j(i)} + \beta_i T_{t-\theta_i} + \varepsilon_{ijt} \quad (3-11)$$

Where:

D_{ijt} = specific discharge from location j in cap i at time t ;

μ = average specific discharge (over all caps, locations, and times);

C_i = difference between average specific discharge for cap i and the overall average;

$L_{j(i)}$ = difference in specific discharge due to location j within cap i ;

ε_{ijt} = random error in specific discharge measurement at location j in cap i at time t ;

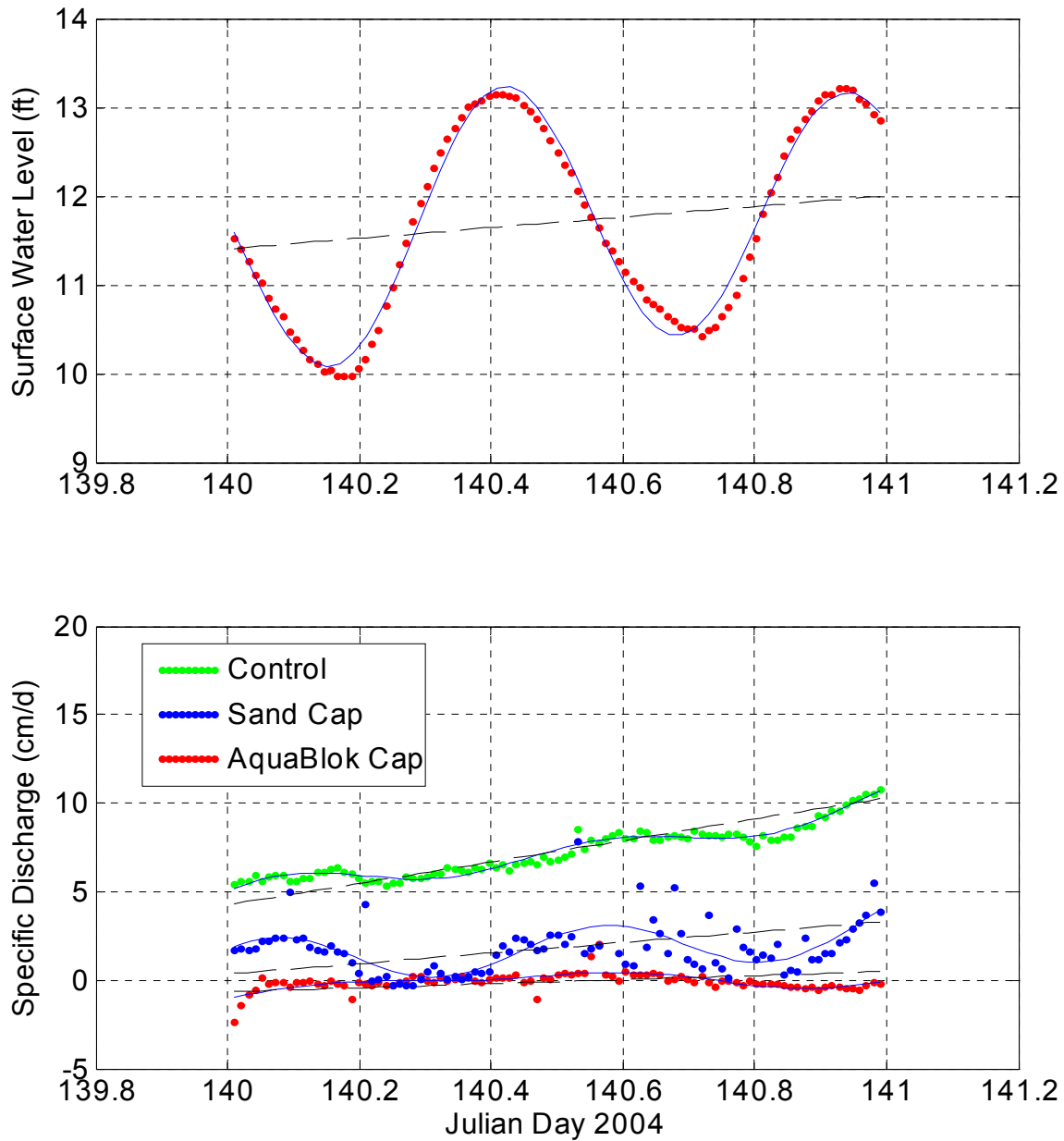

Figure 3-42. Specific Discharge Rates in Demonstration Area During One-Month Post-Capping Survey (top panel is tidal phase, lower panel shows discharge as points, harmonic fit as solid curve, and trend as dashed line)

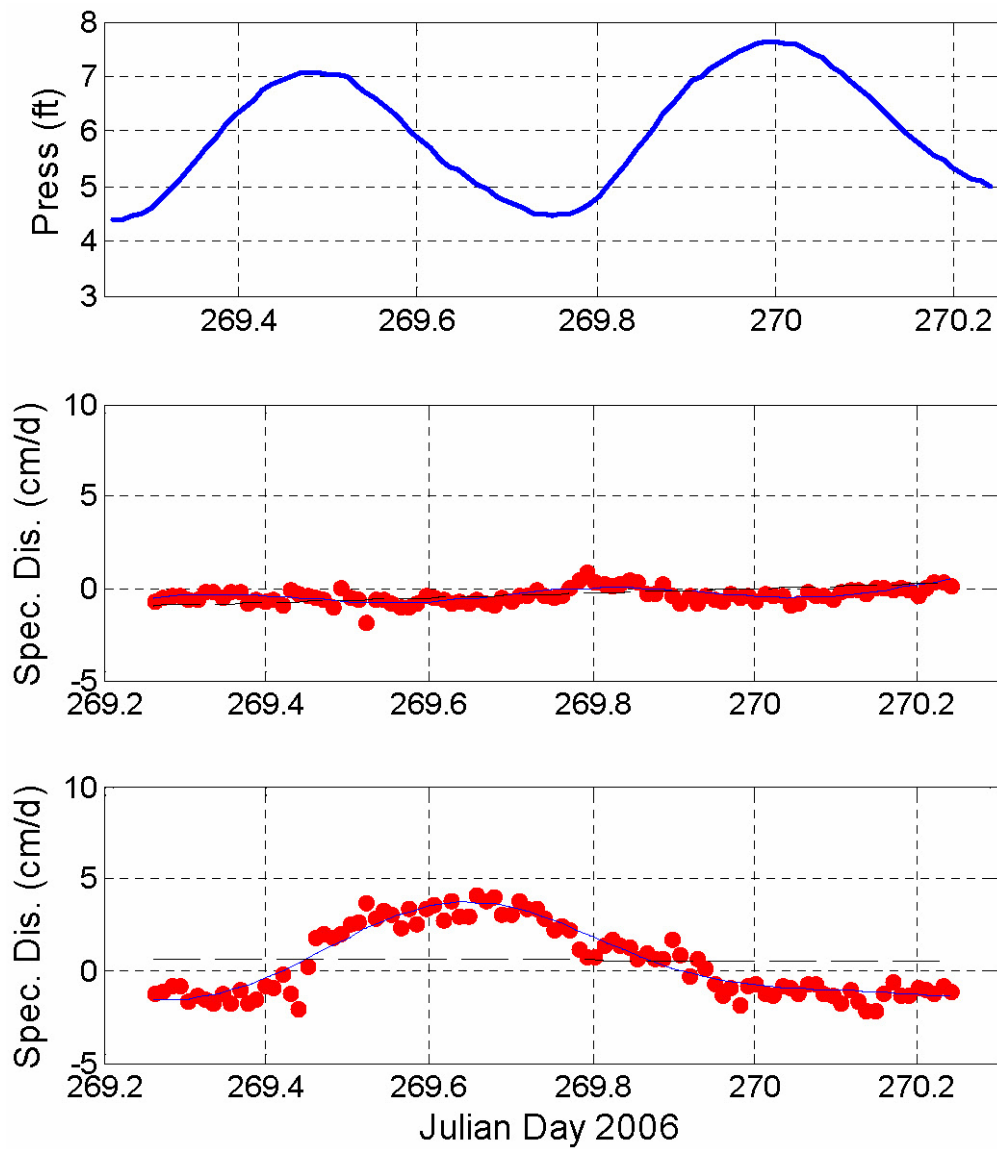

Figure 3-43. Specific Discharge Rates in AquaBlok® Cell During 30-Month Post-Capping Survey (top panel is tidal phase, middle panel is station AQB1, lower panel is station AQB2; discharge shown as points, harmonic fit as solid curves, and trend as dashed lines; note station AQB2 is provided only as reference as station appeared compromised)

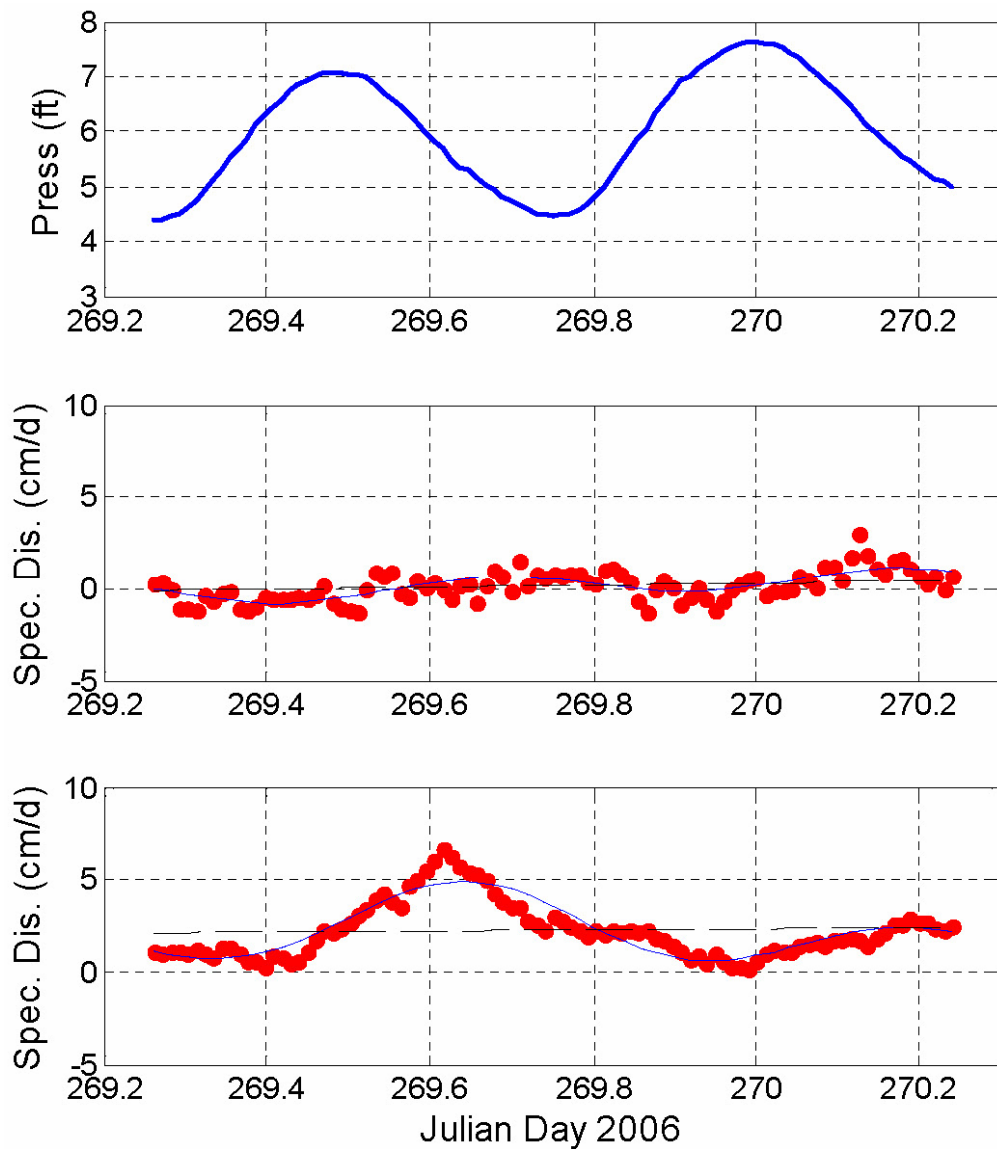

Figure 3-44. Specific Discharge Rates in Sand Cell During 30-Month Post-Capping Survey (top panel is tidal phase, middle panel is station SC1, lower panel is station SC2; discharge shown as points, harmonic fit as solid curves, and trend as dashed lines)

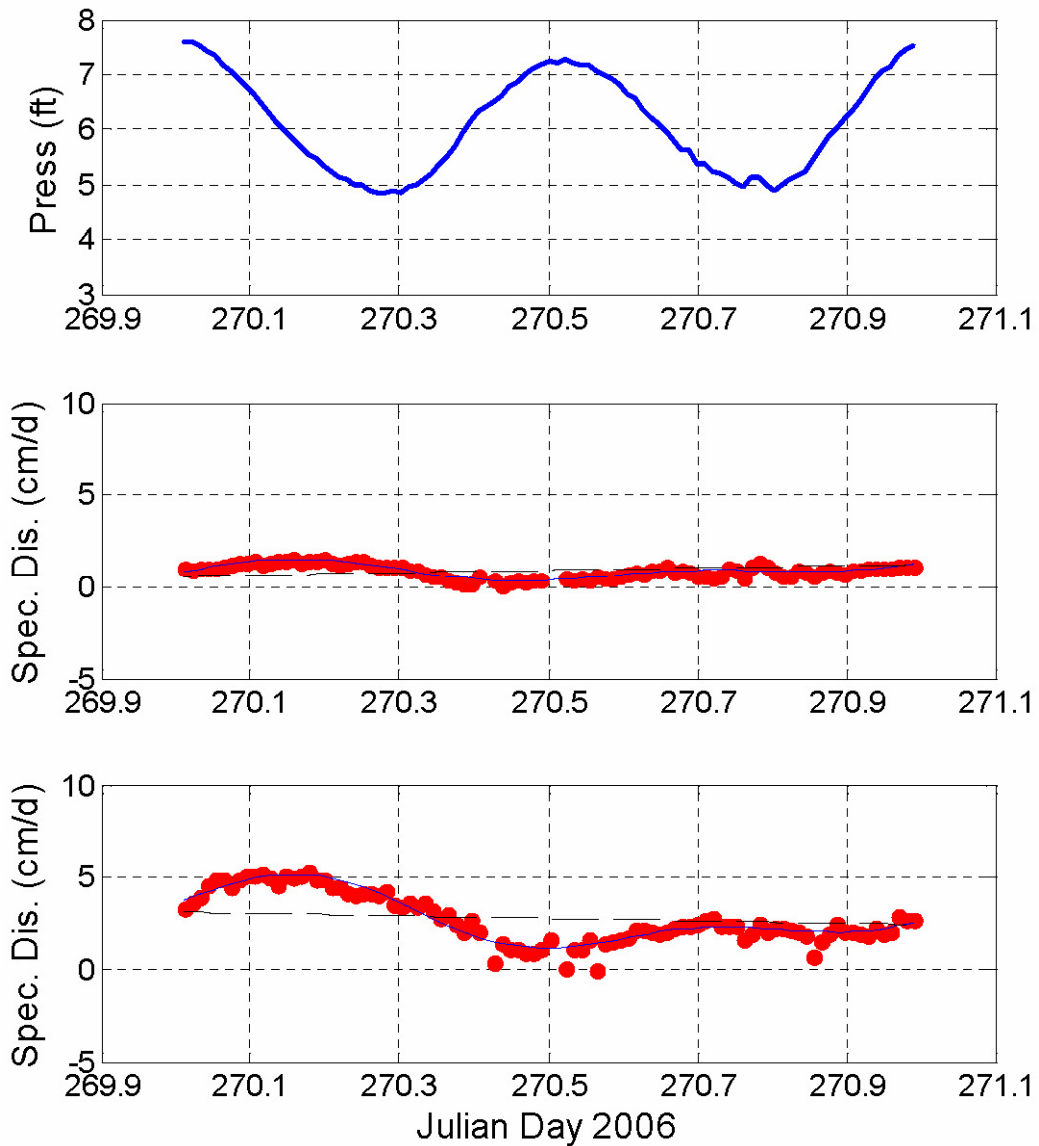

Figure 3-45. Specific Discharge Rates in Control Cell During 30-Month Post-Capping Survey (top panel is tidal phase, middle panel is station CS1, lower panel is station CS2; discharge shown as points, harmonic fit as solid curves, and trend as dashed lines)

Table 3-8. SITE Demonstration Seepage Meter Results

Sampling Event	Cell	Meter Location	Specific Discharge (cm/day)			
			Mean	Minimum	Maximum	Standard Deviation
One-month Post-capping	AquaBlok®	ANA1	-0.10	-2.32	2.05	0.50
	Sand	ANA3	1.67	-0.30	5.54	1.26
	Control	ANA6	7.24	5.34	10.83	1.42
Six-month Post-capping	AquaBlok®	AQB1 ^(a)	2.81	0.99	4.81	0.90
		AQB2	-0.45	-2.16	1.08	0.82
		AQB3	-0.21	-0.65	0.42	0.28
		Average ^(b)	-0.33	-1.41	0.75	--
	Sand	SC2	0.30	-1.24	3.07	0.78
	Control	CS1	-0.30	-1.49	0.60	0.51
		CS2	0.20	-0.76	0.91	0.34
		Average	-0.05	-1.13	0.76	--
18-month Post-capping	AquaBlok®	AQB1	-0.56	-1.98	0.54	0.43
		AQB2	-0.68	-3.14	2.21	1.10
		Average	-0.62	-2.56	1.38	--
	Sand	SC1	2.30	0.00	5.50	1.24
		SC2	-0.81	-2.67	2.03	1.19
		Average	0.75	-1.34	3.90	--
	Control	CS2	0.63	-1.43	3.16	1.34
30-month Post-capping	AquaBlok®	AQB1	-0.32	-1.81	0.97	0.41
		AQB2 ^(c)	0.41	-4.09	4.13	1.96
	Sand	SC1	0.17	-1.29	3.01	0.82
		SC2	2.25	0.15	6.70	1.50
		Average	1.21	-0.57	4.86	--
	Control	CS1	0.90	0.07	1.55	0.36
		CS2	2.81	0.00	5.32	1.34
Average		1.86	0.04	3.44	--	

- (a) Location AQB1 during the six-month post-capping event was outside the AquaBlok® cell; data are provided for reference and are not suitable for averaging with other data.
- (b) Location AQB1 is not included in the average.
- (c) Location AQB2 during the 30-month post-capping was in area where the AquaBlok® cap was potentially compromised; data are provided for reference and are not suitable for averaging with other data.
- Standard deviation not calculated for average.

$T_{t-\theta}$ = measured tide at time $t-\theta$ (with shift θ averaged over all caps);

$T_{t-\theta_i}$ = measured tide at time $t-\theta_i$, with a cap-specific shift;

β = effect of tide on discharge (average over all caps and locations); and

β_i = effect of tide on discharge in cap i

Model 1 (Equation 3-9) is the simplest model, expressing the specific discharge as a function of the capping cell, with random differences due only to meter location within each cell. Model 1

was fitted separately to the entire dataset for each of the relevant 24-hour data periods, using two different assumptions concerning the error: (a) that the errors are independent, and (b) that the errors are related. Resulting Model 1a is the simpler model, with independent errors for each observation, while resulting Model 1b allows for correlated errors. Model 2 (Equation 3-10) extends the basic model to account for the effects of tidal stage on the specific discharge, specifically by an amount proportional to the tide height. In addition, preliminary examination of the data showed that the effects of the tide were offset in each cell, usually by approximately four

to five hours (i.e., “tidal lag”). Thus, Model 2 also incorporated this offset. In Model 2, the tide effect and offset were kept constant across all caps and monitoring locations. In Model 3 (Equation 3-11), additional complexity was introduced by allowing the tide effect and tide offset to vary for each individual monitoring station.

Statistical analysis consisted of fitting the model to the data and performing multiple comparisons between the three treatments (i.e., AquaBlok[®], sand, and control cells) within the individual models. This was done using Tukey multiple comparisons after accounting for all model terms.

Table 3-9 shows the estimated mean specific discharge for each cell for the various sampling periods and models. These means were compared using Tukey multiple comparisons, and there were no statistically significant differences at any p-value found between the means for the various cells within any model.

The use of sequentially more complex models provided increasingly more accurate attempts to allocate the variability in the model to the different factors that likely affected the specific discharge. It was hoped that as the models became more sophisticated, the capping methods would, indeed, show statistically significant differences. This was not the case. However, Table 3-9 does show an interesting result. The estimated mean specific discharge did not vary between cells within the various models with the exception of Model 3. In this case, because separate tide offsets were used for each capping cell, there was often less usable data for the analysis, whereas the amount of usable data for the other three models was consistent. As a rule, therefore, the estimated means for Models 1a, 1b, and 2 may be more representative of true conditions simply given the more robust datasets applicable to each. In addition, on general visual inspection of the sample data, it does appear likely that the AquaBlok[®] cap allowed smaller discharge on average than the sand cap and native sediments (i.e., Table 3-8 shows that mean and maximum specific discharge rates were empirically lower in the AquaBlok[®] cell compared to the sand and control cells for all

events), although this can not be statistically shown at a reasonable level of significance.

3.3.2.2 Objective #2 Results – Non-critical Measurements. There were no identified non-critical measurements for this objective.

3.3.3 Objective #3 – The Influence of An AquaBlok[®] Cap on Benthic Flora and Fauna

As indicated in Section 3.2.1, a key concern in applying AquaBlok[®] as an innovative sediment capping alternative is the long-term effect of this material on habitat for faunal (benthic) communities, and also on potential habitat for floral communities (which would necessarily depend on site-specific water levels and suspended sediment loads as they relate to a favorable setting for emergent and/or submergent vegetation). Standard (i.e., non-amended) AquaBlok[®] material is inherently low in organic content, and is not generally designed specifically to support significant biological growth. However, the AquaBlok[®] cap constructed during the SITE demonstration was covered by a sand layer that would likely support some level of biological growth and allow for a comparison between benthic impacts of the sand-covered AquaBlok[®] cap and the sand-only cap (e.g., benthic infaunal species impacts such as diversity and richness). In addition, AquaBlok[®] is quite similar in terms of grain size to the native sediment found in the demonstration area (and at most contaminated sediment sites), and could therefore itself prove a viable habitat for benthos that rely on a fine-grained substrate. Given the water depth and turbidity in the study area, floral assemblages were not found, and were therefore not assessed.

To evaluate the influence of AquaBlok[®] on benthic communities relative to sand and native sediments, the following critical and non-critical measurements were identified and assessed through data collection during the various SITE demonstration sampling events.

Critical Measurements

- None

Table 3-9. Results of the Statistical Comparison of Specific Discharge between Cells (statistically significant differences were not observed at any confidence level)

Sampling Event	Model	Mean Specific Discharge (cm/day)		
		Control	Sand	AquaBlok®
One-month Post-capping	1a	7.2776	0.3513	-0.0998
	1b	7.3461	0.3353	-0.1668
	2	7.2717	0.3573	-0.1057
	3	14.0044	-7.1242	7.9703
Six-month Post-capping	1a	-0.0506	0.3196	-0.3206
	1b	-0.0421	0.3511	-0.2891
	2	-0.0974	0.3480	-0.3510
	3	-1.5597	2.9017	-0.1541
18-month Post-capping	1a	-0.8126	0.7403	-0.6259
	1b	-0.8003	0.7284	-0.7290
	2	-0.7706	0.7757	-0.6831
	3	-3.2289	-2.0849	3.4187
30-month Post-capping	1a	1.8550	1.2104	0.1160
	1b	1.8503	1.2250	-0.0348
	2	1.7743	1.2497	0.1552
	3	0.9908	0.2301	1.9486

Non-critical Measurements

- Benthic grab sampling and descriptive and statistical benthic assays; and
- Benthic assessment through SPI

3.3.3.1 Objective #3 Results – Critical Measurements. There were no identified critical measurements for this objective.

3.3.3.2 Objective #3 Results – Non-Critical Measurements

3.3.3.2.1 Benthic Grab Sampling and Descriptive and Statistical Benthic Assays. Benthic grab sampling and descriptive and statistical assays were conducted only during the 30-month post-capping field event, as described in Section 3.2.4. Thirty six total sediment grab samples (three samples from each of the four quadrants within the AquaBlok®, sand, and native control cells) were collected to evaluate benthic infaunal communities. Figure 3-46 shows the locations where benthic grab samples were collected. Figure 3-46 also shows the sampling locations from a baseline pre-capping benthic survey that was conducted but was not part of the SITE demonstration

summarized in this ITER. Nevertheless, this baseline ecological survey was critical in deriving conclusions related to benthic impacts of the capping activities.

The main objective of the infaunal study was to examine the potential influence of the AquaBlok® cap on the benthic community structure expected to populate Anacostia River sediments (as demonstrated by native control sediments) relative to the influences of sand capping material. The benthic assays and statistical analyses conducted demonstrate that there were substantial physical habitat differences between the control cell and the two capped cells (i.e., AquaBlok® and sand) during the 30-month post-capping benthic survey. This was not surprising given that the native, primarily silty/clayey river bottom was covered by sand or a combination of sand and AquaBlok® at the capped cells. The AquaBlok® and sand capped cells were relatively similar to each other, but still were noticeably distinct. The difference probably was primarily related to differences in the fine sand particle size fraction (higher in the sand cell) and the gravel particle size fraction (higher in the AquaBlok® cell).

Despite the differences in habitats between the control cell and the AquaBlok® and sand cells, the faunal communities identified during the 30-month post-capping event showed somewhat surprising overall similarity among the cells. Specifically, all of the sites sampled shared 15 of 22 ecological taxa. Some taxa encountered at the site (e.g., *Limnodrilus*) are capable of burrowing deeply into sediments, but most observed typically occur at depths up to or less than 10 cm in the sediment and have relatively little effect on sediment properties below that depth (Mermillod-Blondin et al. 2003). The oligochaete worm *Branchiura sowerbyi*, which is a deep-deposit-feeding species that burrows to depths of 20 cm (Wang and Matisoff 1997), was not found at either the AquaBlok® or sand capped cell, but was found in the control cell. The relatively high similarity among all three cells probably resulted from the widespread occurrence of six or seven species that varied in abundances among sites. In addition, despite the general similarity among cells, the control cell community was clearly distinct from the communities at the AquaBlok® and sand capped cells. Most of the stations within the AquaBlok® and sand capped cells were quite similar to each other, but again showed distinct differences between cells. The most likely factors explaining the differences between the AquaBlok® and sand capped cells were the relative abundances of *Dero nivea* and chironomid larvae, both of which were more abundant in the AquaBlok® cell (see Figures 3-47 and 3-48, which are both box plots demonstrating general summary level statistical qualities of the data common of this type of visual data display).

Overall, benthic habitats and faunal communities in the AquaBlok® and sand cells were more similar to each other than to those in the control cell, but retained differences that clearly separated them from each other. In particular, the AquaBlok® stations had relatively equal or greater abundances of individuals in the major taxonomic groups found to occur in the sand cell (see Figure 3-49, which is a box plot demonstrating general summary level statistical qualities of the data common of this type of visual data display). This could be taken to indicate that the AquaBlok® cell was a more suitable habitat

for benthic recolonization. However, this conclusion is made tenuous by the presence of the sand cover over the AquaBlok® material which essentially presented the same habitat as the sand capped cell (with the exception of total thickness). In addition, the 2006 survey data represent single snapshots of infaunal communities that can vary seasonally and annually and therefore are of limited use in accurately predicting a longer term response of the benthos to the AquaBlok® and sand caps.

The concentrations of metals in the native sediment were at least 10 times greater and up to 30 times greater than the concentrations of metals in the AquaBlok® and sand capping materials. PAHs were 30 to 40 times greater in the uncapped sediment, and total PCBs were up to 95 times greater than they were in the AquaBlok® and sand cap materials. Because the capping materials were much less contaminated than the native sediment, ecological assemblages more commonly associated with less contaminated sediments may increase over time in cap materials, potentially differentiated by physical cap material attributes (i.e., the sandy nature of the sand cap material versus the clayey nature of AquaBlok®). However, if the depth of the fine sediment fraction observed to be accumulating over the AquaBlok® and sand caps, and potentially the associated concentrations of organic contamination in this surficial layer, were to increase through time, ecological assemblages in both caps could potentially converge and become more similar to the control cell.

The SITE demonstration did not include the specific benthic assessment of an uncontaminated reference area in the Anacostia River and, thus, it is not possible to compare benthic recolonization in the AquaBlok®, sand, and native sediment cells from the demonstration area to unimpacted areas.

Appendix F provides additional detail related to the benthic assays and statistical evaluations conducted during the AquaBlok® SITE demonstration as they relate to objective #2.

3.3.3.2 Benthic Assessment Through Sediment Profile Imaging. SPI surveys were

conducted during the one-month, six-month, 18-month, and 30-month post-capping surveys, as described above in Section 3.2.4. During each survey, a total of 12 locations were evaluated using SPI in the AquaBlok[®], sand, and control cells. Specifically, nine locations were assessed in each cell using the video SPI camera, and three locations in each cell were evaluated using the standard SPI camera. In addition, reference stations outside the control cell and either nearer to or in the Anacostia River navigation channel were also assessed to provide further information for comparisons to the control and AquaBlok[®] and sand capped cells. Between the various surveys, individual SPI locations were generally replicated with a reasonable lateral offset to provide the most meaningful data comparisons between the sampling events. Figure 3-37 shows the SPI locations assessed during each sampling event. Accurate positional control of the SPI drops during each sampling event was achieved by operating the survey vessel in a very controlled fashion and by using a dGPS linked to accurate navigational software. All sediment profile images were processed as described in Section 3.3.1.2.1, and were subsequently analyzed visually for specific ecological features of interest, including the presence of organisms and physical indicators of the presence of organisms (e.g., burrows or tubes).

During the SPI assessment, certain ecological measures could not be evaluated, as follows:

- Mud clasts - Mud clasts were not present in adequate quantities to measure during the demonstration. This was not surprising due to the sand and gravel sized capping material in the AquaBlok[®] and sand cells.
- RPD depth - There was no observable RPD layering in sediments due to an apparent gradual oxygen reduction gradient. This is not atypical for a shallow water, tidally influenced, riverine environment.
- Infaunal successional stage - The criteria defining the developmental stages present in the Anacostia River were not visible during the demonstration. Invertebrate assemblages were not observed in

adequate detail through SPI to measure meaningfully, which is common in a physically dominated environment.

- osi - Due to the inability to define RPD depths and successional stage, it was not possible to calculate osi during the demonstration.

From an ecological standpoint, the relevant general findings of the SPI surveys conducted during the demonstration include:

- Gas filled voids were a prominent subsurface feature during all sampling periods. It appears that sediments at most monitoring stations contained adequate concentrations of organic detritus to support a high rate of methanogenesis as evidenced by the occurrence of gas filled voids at most stations.
- There were significant declines in gas void occurrence over time, which may have been related to the weight of cap material squeezing gas out of the sediments at a rate faster than microbes generated gas (see Figure 3-50). The decline was likely not related to reduced microbial activity in the river, as the presence of gas within the control cell and channel stations remained high through time. Gas voids were generally observed at the lowest rate in the sand cell, and no voids were observed in the sand cell during the final two monitoring events.
- Biogenic activity of infauna was not a predominant factor in structuring subsurface sediments at any monitoring station. There were few biogenic structures, other than the aforementioned gas voids and small tubes.
- Some small infaunal organisms were observed in the sand capping material in the sand cell and in the sand cover and AquaBlok[®] material in the AquaBlok[®] cell. The presence of infaunal worms at monitoring stations in the demonstration area indicates that benthic habitats were supporting benthos populations.

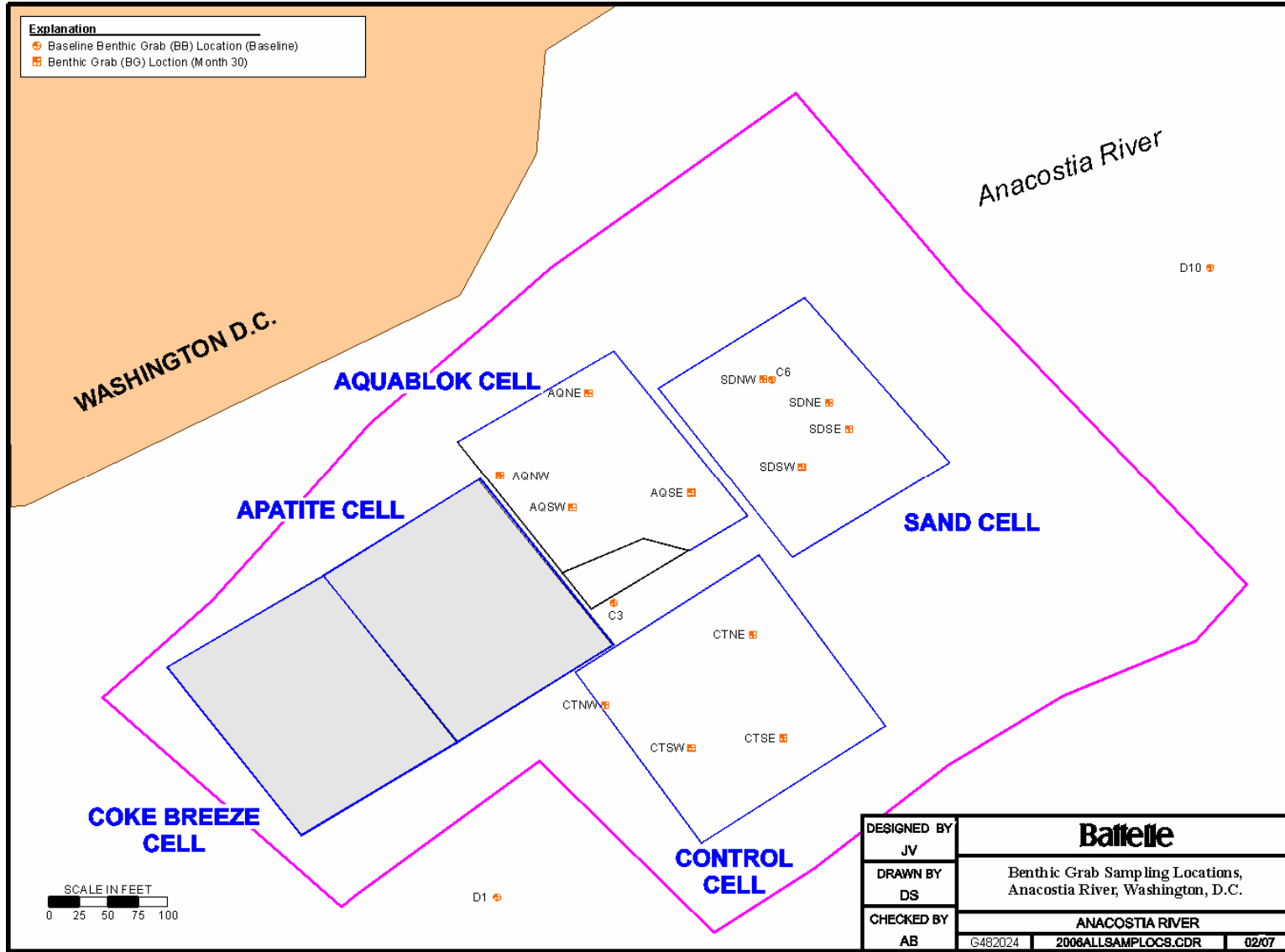

Figure 3-46. Benthic Grab Sampling Locations (Including Baseline)

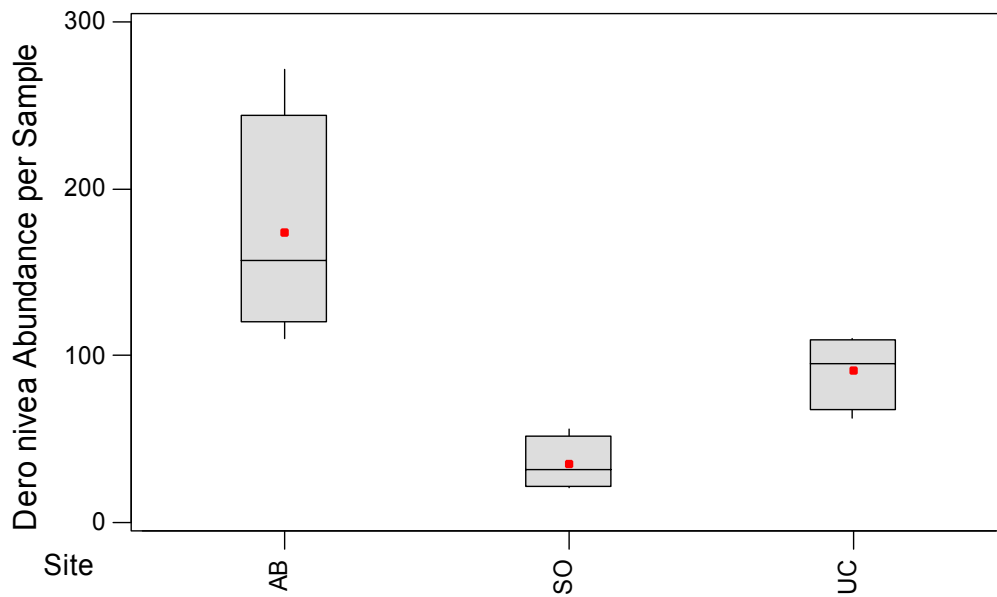

Figure 3-47. Abundance of *Dero nivea* in AquaBlok (AB), Sand (SO), and Control (UC) Cells (red dot represents the mean and horizontal line represents the median)

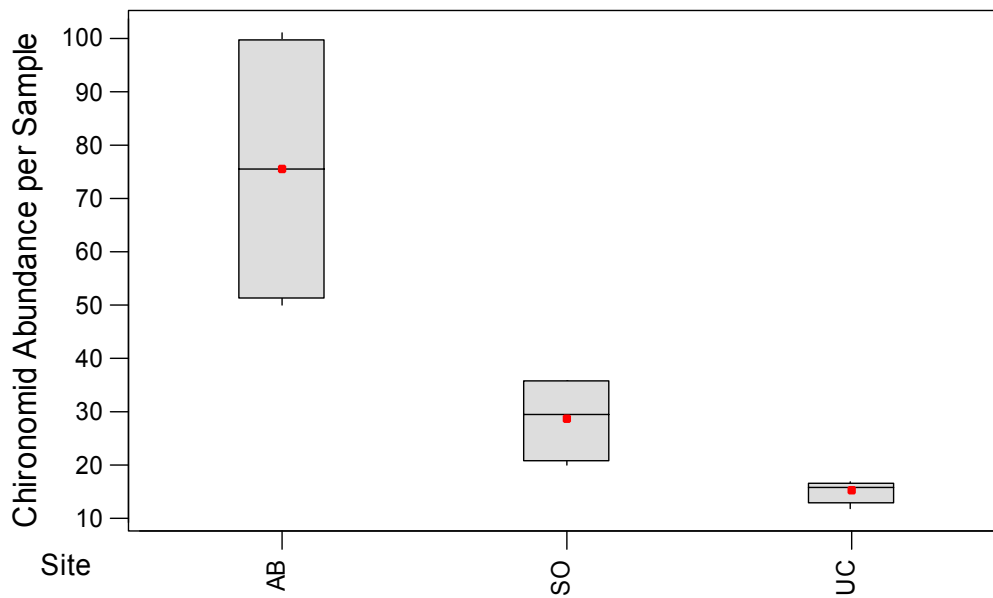

Figure 3-48. Abundance of Chironomid Larvae in AquaBlok (AB), Sand (SO), and Control (UC) Cells (red dot represents the mean and horizontal line represents the median)

-
- The prominent functional group observed during the demonstration was the subsurface deposit feeding oligochaetes. Oligochaetes typically dominate tidal freshwater systems but generally do not occur in densities high enough to overcome physical processes in the structuring of sediments (Diaz and Schaffner, 1990).

The presence of even the limited number of infauna observed in the AquaBlok® material indicates a theoretical potential for bioturbation to reach below the cap and mobilize contaminants from native sediments. However, homogeneous benthic habitats typical of tidal freshwater typically do not support a diverse benthos capable of significantly bioturbating COCs.

Overall, the surface sediment environment within the tidally influenced freshwater environment at the site appears to be controlled by physical processes and does not appear to support a highly structured benthic community, limiting the power of image data in directly understanding ecological recovery rates. Hence, biogenic activity does not appear to be a factor, negative or positive, in cap longevity. Benthic organisms in the system appear from the SPI imagery to be dominated by very small oligochaetes that were generally unquantifiable in the images, and larger benthic organisms were not observed. However, snails were observed during coring activities and surface grab sampling for benthic infaunal analysis. Indirect indications of the benthos community, such as RPD and color, show no observable restrictions to benthic community colonization within the AquaBlok® cap system, other than grain size, when compared to the contaminated native sediments or the sand only cap. The SITE demonstration did not include the specific benthic assessment of an uncontaminated reference area in the Anacostia River and, thus, it is not possible to compare benthic recolonization between the demonstration area image data and unimpacted areas.

Were significant benthic communities to be present in the cap areas, it is possible that bioturbation could potentially affect the ability of the caps to provide effective contaminant isolation (i.e., through vertical mixing or the creation of preferential contaminant migration pathways). However, cap thickness in both the

AquaBlok® and sand cap areas was consistent with or greater than the typical bioturbation depth of most common benthos, suggesting that even a robust population of benthos would not likely have significantly impacted contaminant distribution during the demonstration.

The AquaBlok® cap was covered with a sand layer, and the presence of benthos in the AquaBlok® cell was most closely related to the sand covering layer as opposed to the AquaBlok® cap material itself. However, given that the grain size composition of the AquaBlok® material is generally consistent with the native sediment in the Anacostia River (i.e., with the exception of the gravel size component, AquaBlok® is almost entirely fine grained as is the native sediment), it does not appear that there is a physical grain size limitation to the benthic colonization of AquaBlok®. This is supported by the observation of some benthos in the AquaBlok® material during the SPI surveying. AquaBlok® caps are frequently designed with a sand covering layer to accommodate a required minimum cap thickness (i.e., while only a thin layer of AquaBlok® may be required to form a suitable isolation barrier, there could be a design requirement to achieve a greater minimum thickness, and, assuming it would be resistant to erosion, sand would potentially be used to make up the additional required thickness) or to provide a more suitable habitat compatible with existing ecology (i.e., where AquaBlok® is used to cover a characteristically more coarse-grained environment) but it is not a design requirement that this sand layer be included. Importantly, absent a sand covering layer, benthic recovery in an AquaBlok® cap may not, in environments where native sediments are characteristically fine-grained, be subject to physical constraints of grain size. This SITE demonstration did not provide data suitable to determine the relative benthic recovery rates in AquaBlok® itself.

Appendix C provides additional detail related to the SPI surveys conducted during the AquaBlok® SITE demonstration as they relate to objective #2.

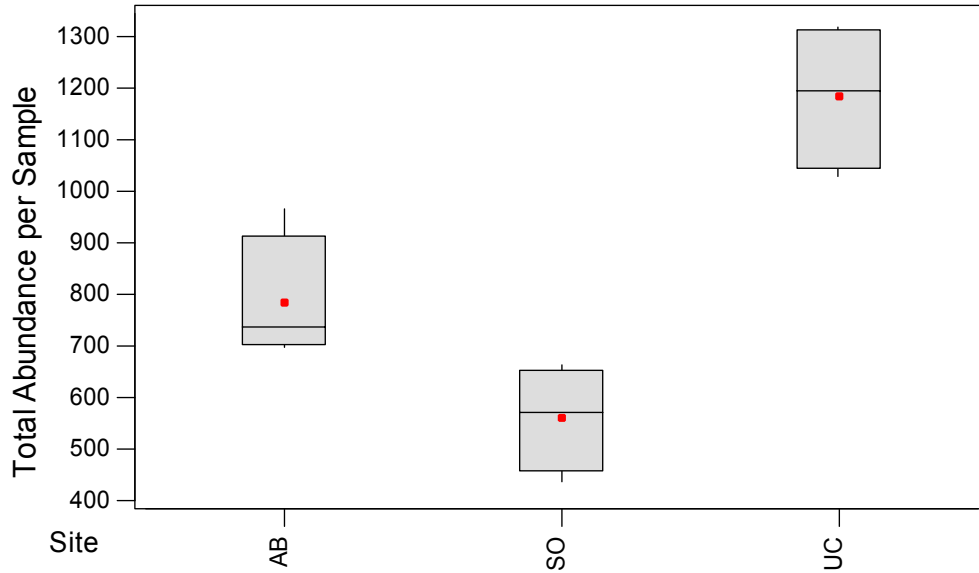

Figure 3-49. Total Benthos Abundance in AquaBlok (AB), Sand (SO), and Control (UC) Cells (red dot represents the mean and horizontal line represents the median)

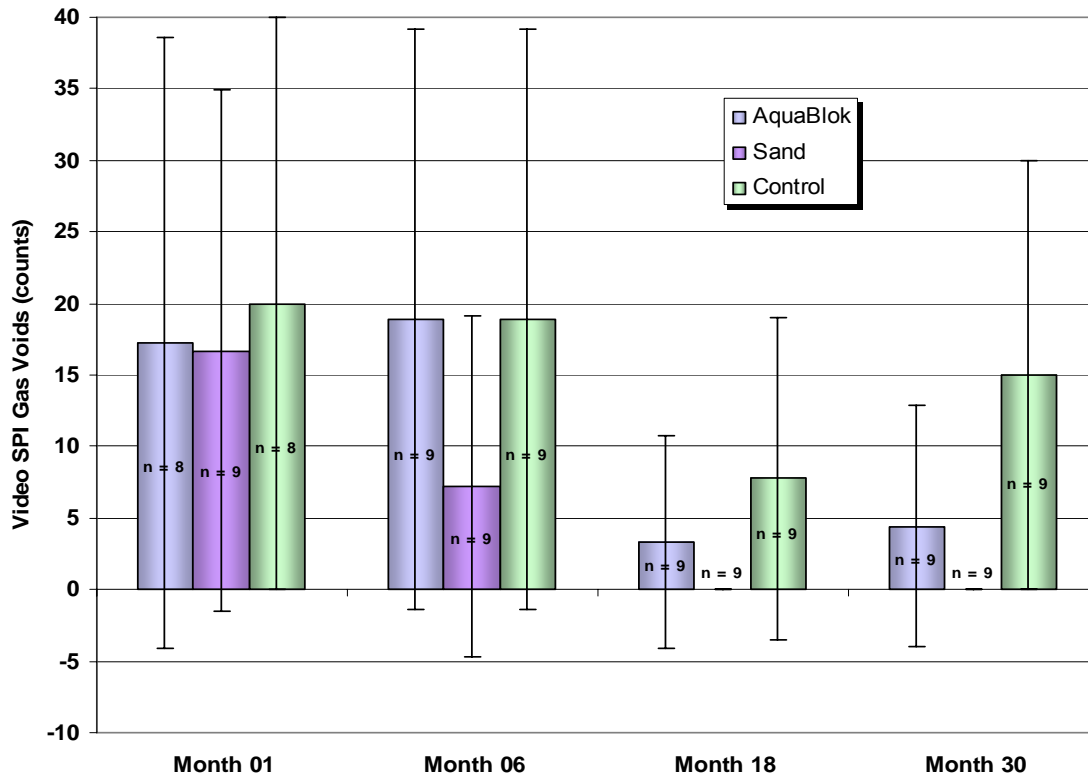

Figure 3-50. Gas Void Occurrence Trend in Video SPI (columns represent the mean, n is the population size, and error bars represent 95% upper and lower confidence intervals around the mean)

Section 4

Economic Analysis

The primary purpose of this economic analysis is to summarize costs incurred in deploying AquaBlok® at pilot-scale through the Anacostia River SITE demonstration, and estimated costs for deploying a standard formulation of AquaBlok® at full-scale at a contaminated sediment site for the purpose of isolating sediment contamination and mitigating human health and ecological risks. The majority of the information in this section was provided directly by AquaBlok, Ltd., and was not independently verified. It is therefore true and accurate to the extent that AquaBlok, Ltd. provided true and accurate information.

4.1 SITE Demonstration Pilot-Scale AquaBlok® Capping Costs

The primary objectives of the evaluation of AquaBlok® as an innovative sediment capping technology under the SITE program were (1) to assess its relative stability, (2) to assess its ability to provide a low-permeability barrier to flux of contamination, and (3) to assess its effect on flora and fauna. These measurement endpoints were evaluated using a number of field sampling tools, including the deployment of seepage meters and the collection of multiple sediment cores. Consequently, in initiating the SITE demonstration there was an overall emphasis on ensuring adequate coverage of the cap area and a sufficient cap thickness for sampling purposes. Section 3 provides additional detail on the overall objectives of the SITE demonstration and the measurement tools used to assess AquaBlok® performance.

A detailed analysis of installation costs was not completed for the AquaBlok® pilot-scale cap due to the nature of the SITE program, the use of common equipment for construction of multiple pilot test caps using different materials, the small

scale of the application, and particular project emphasis on the iterative evaluation process necessary to better identify and describe the relative performance attributes of the AquaBlok® material. That is, as the nature of the project placed more emphasis on the performance of the AquaBlok® cap relative to that of more traditional capping material, and because common construction equipment and techniques were selected for the overall project, the aspect of *overall efficiency* in cap construction, which translates directly into *overall capping costs*, was secondary. Nevertheless, some observations can be provided regarding the SITE program costs relative to the importance of the level of care taken during the process of construction monitoring to ensure construction of the cap design (and minimum thickness) as intended.

4.1.1 SITE Demonstration As-Built AquaBlok® Cap

The specific AquaBlok® formulation used for the SITE demonstration was “3070 FW”, a nomenclature that indicates the material was a freshwater formulation consisting of 30% clay and 70% aggregate on a dry weight basis. The AquaBlok® incorporated a No. 8 (i.e., 0.094 to 0.375 in diameter) aggregate as a core. Using this particular formulation, and based on preliminary laboratory column testing conducted by the vendor in support of the SITE demonstration in the Anacostia River, a “dry” product thickness of approximately three in was required to construct a basal AquaBlok® layer at the targeted hydrated (expanded) thickness of approximately 4 in (see Section 3.1.1.2). At a dry product bulk density of approximately 85 pounds per square foot (lbs/ft²), this target 3-in dry thickness translated to a target dry application rate of approximately 21 lbs/ft².

Given the final target cap placement area of approximately 8,000 ft², a total of approximately 85 tons of AquaBlok[®] product was needed for cap construction. The contractor responsible for cap construction (as indicated in Section 3.1.1.2, the AquaBlok[®] cap was not constructed by Battelle on behalf of EPA NRMRL, but rather by a separate contractor acting pursuant to an investigation separate from the SITE demonstration summarized and discussed in this ITER) requested delivery of a total of 110 tons of product to the site. The extra quantity of product ordered (i.e., approximately 25 tons) was intended to address potential on-site wastage and other contingencies, and was also based on an initial target cap placement area of 10,000 ft² (rather than the 8,000 ft² cap area ultimately placed – see Section 3.1.1.2).

Confirmation core samples were collected by the contractor during actual construction of the AquaBlok[®] cap. Over the approximately three-day period during which AquaBlok, Ltd. personnel were on site during cap construction, the contractor was observed to collect a total of 19 confirmation core samples, generally within 10 minutes to several hours from product placement. Eighteen of the cores were observed to contain measurable quantities of “dry” AquaBlok[®], with measured initial material thicknesses (while still in coring tubes) ranging from approximately 2.5 in to approximately 7 in. For the majority of cores, AquaBlok[®]/sediment interfaces appeared relatively distinct (indicating minimal mixing), although some degree of penetration of AquaBlok[®] particles into the underlying sediment was observed by AquaBlok, Ltd. personnel to occur in most cores (up to depths of approximately 0.5 in). Furthermore, a number of the 18 cores clearly displayed the presence of previously placed (i.e., hydrated) AquaBlok[®] overlain by newly placed (non- to only slightly hydrated) product, indicating overlapping or “double” coverage of the product in some areas.

Overall, using the contractor’s on-site measurement data from cap placement confirmation sampling, the mean value for initial (“dry”) AquaBlok[®] thickness within the 18 core samples was approximately 3.1 in. This calculation considered total cap material

thickness (including any overlapping) but did not include the quantity of AquaBlok[®] observed to penetrate the native sediment surface. The mean thickness for dry AquaBlok[®] *appeared* consistent with the dry thickness of product required for construction of the hydrated cap.

By the end of cap construction, and based largely on survey data generated during cap placement, AquaBlok[®] product had been placed across approximately 90% of the total 8,000 ft² target area. Less-than-complete coverage of the entire 8,000 ft² area can be attributed to a combination of factors, including a dwindling supply of bulk product available towards the end of the construction phase coupled with a desire on the part of the cap construction contractor to not extend construction beyond a limited number of working shifts. Specifically, equipment and material barges were left essentially stationary over one corner of the 8,000 ft² AquaBlok[®] cap footprint. Coverage of the final 10% of the total cap area would have required repositioning equipment and material-holding barges, and there was an apparent reluctance to do this to avoid extending cap construction into another consecutive work day.

Based on simple mass-per-area calculations, the dwindling supply of product available towards the end of the construction phase was largely due to over-application of product despite the approximately 3-in average value measured in the 18 initial confirmatory core samples. That is, a total of 110 tons of product (220,000 lbs) was placed across approximately 7,200 ft², translating to a site-wide application rate of approximately 31 lbs/ft², which is well above the targeted application rate of 21 lbs/ft². At this site-wide application rate, dry thicknesses of AquaBlok[®] actually measured in most core samples *should have been* closer to about 4.5 to 5 in (rather than the actual measured average of approximately 3 in). The fact that measured thickness data do not reconcile directly with thicknesses predicted from mass-per-area calculation is likely because areas where AquaBlok[®] was placed at greater than design thickness were apparently not adequately represented during the construction monitoring and confirmation core collection process and quantities of AquaBlok[®] material observed to

penetrate the sediment surface were not included in the contractor's thickness measurements.

Other, earlier demonstrations of AquaBlok[®] placement, particularly the Ottawa River Capping Demonstration funded by the Ohio Lake Erie Commission, have been specifically designed to demonstrate effective placement over larger areas (2.7 acres in the case of the Ottawa River project) at lower application rates (as low as 12.5 to 16 lbs/ft²) and to document application costs and production rates for a variety of application techniques (Hull & Associates, Inc., 2002). In addition, AquaBlok[®] pilot applications and full-scale projects completed by others have achieved application rates on the order of the original Anacostia SITE demonstration target rate within relatively good tolerance levels and at equivalent placement rates of approximately one acre per day.

4.1.2 SITE Demonstration AquaBlok[®] Pilot Costs

Product cost for the Anacostia SITE demonstration pilot-scale AquaBlok[®] cap (i.e., AquaBlok[®] and covering sand) was initially estimated at approximately \$2 to \$3 per ft². This initial cost estimate was based on placement of a 3-in thick dry AquaBlok[®] layer, which, as discussed above, corresponds to a dry product application rate of approximately 21 lbs/ft². A product cost of \$170 per ton (i.e., the actual AquaBlok[®] material cost for the Anacostia cap construction phase), assuming placement at the target thickness over the entire capping area, yields a cost of approximately \$1.80 per ft² for the AquaBlok[®] capping material evaluated during the SITE demonstration.

4.2 Full-Scale AquaBlok[®] Application

4.2.1 Site-Specific Factors Affecting Cost

Site-specific factors that will affect overall full-scale costs for AquaBlok[®] capping projects include (in approximate order of relative sensitivity):

- Salinity;
- Project location;

- Project size;
- Performance criteria;
- Composite cap design elements; and
- Regulatory constraints

AquaBlok[®] formulations designed to function in full-strength seawater require clay mineral blends (such as attapulgite) that can materially increase formulation costs.

Geographical project location and accessibility can impact project costs primarily as a result of greater shipping and packaging costs. Local manufacture can eliminate many of these costs, but typically it is only practical for sites over two to three acres in size. Similarly, installation costs can be greater if access is not readily available, requiring mobilization and use of specialty equipment, or lengthy barge transport cycles to feed the installation equipment.

Project size will influence per-acre costs in several ways. Smaller projects often do not economically justify mobilization for local manufacture, resulting in the need to package and ship capping materials to the site. Transportation costs can add substantially to an overall project cost. For example, the relatively small amount of material for the Anacostia River SITE demonstration pilot project cost \$31,300 via free on board (F.O.B.) shipping to the site (\$18,700 for AquaBlok[®] material and \$12,600 for packaging and shipping).

Similarly, costs for mobilization and demobilization of construction application/installation equipment must be recognized in addition to actual application costs, and must be applied over the entire application area. Thus, a relatively small project area that cannot adequately be reached by shore-based equipment might require the mobilization of barges, or if water depths are insufficient to float barges, might require the use of aerial application methods (e.g., helicopter). Such factors could result in significantly higher per-acre installation costs for smaller sites as compared to larger application areas.

Although AquaBlok[®] can and has been successfully used in construction of "monolayer"

cap designs, most applications of AquaBlok[®] incorporate its use as part of a composite cap, potentially including the use of a sacrificial absorbent or stabilization layer beneath the AquaBlok[®] cap, followed by a sand layer for benthic isolation purposes or stone armoring for increased protection from scour in higher-energy environments. The cost of the AquaBlok[®] component will be impacted directly by the relative thickness of the AquaBlok[®] portion of a composite cap. While a total freshwater cap thickness of approximately 6 in is often desired to address ecological risks, a thinner (e.g. 3 to 5 in thick) hydrated AquaBlok[®] cap at the base of a sand cap can often provide adequate chemical isolation of sediment-borne contaminants. As in the Anacostia SITE demonstration capping project, AquaBlok[®] material has been successfully applied at other project sites with a 2 to 3 in application (pre-hydrated) within acceptable tolerances.

Performance criteria will also impact the relative cost of AquaBlok[®]. If amendments are required to provide enhanced reduction of contaminant flux (particularly for organic compounds or methylated mercury), or if the cap design requires treatment gates to address gas ebullition or groundwater upwelling, the material costs will be greater in proportion to the cost of the amendments required.

Other regulatory constraints, such as access restrictions due to fish spawning (i.e., “fish windows”) or migratory waterfowl use, could impact the timing of cap installation, possibly requiring multiple site mobilizations or constrained working hours. In addition, the applicability of permit programs could constrain a capping remedy. Other constraints could include physical access issues, tidal periods, the presence of high hazard conditions (e.g., unexploded ordinance [UXO] or free-phase product) that could require special materials and methods.

4.2.2 Issues and Assumptions

Similar to the Anacostia River study area where the SITE program was conducted, many sediment cap applications can be accomplished

to address environmental risk issues resulting from common contaminants such as heavy metals, PAHs, and PCBs. These contaminants are often found in combination to some degree as a legacy of commercial and industrial activities, are often co-located as a result of contaminant/sediment transport and deposition phenomena, and typically have a common affinity for fine-grained matrix particles such as typical subaqueous sediments. For purposes of examining relative AquaBlok[®]-based cap implementation costs, various application parameters can be assumed for which more detailed cost assumptions and estimates can be provided. However, it is important to note that, because the Anacostia River site is fairly typical of many sites, the assumptions that follow could reasonably apply to a full-scale implementation of a cap at such a typical location as well.

For a “typical” application scenario, it is reasonable to assume a 3 to 4 in thick, hydrated layer of the 3070 FW AquaBlok[®] formulation (achieving an in situ permeability of 10^{-8} cm/sec or less) would be appropriate to provide chemical isolation, absorption, and/or suitable cation exchange capacity for metals. Such an application would also have sufficient bearing capacity to support an overlying 3-in sand layer intended to provide additional bioturbation isolation and benthic restoration capacity. For purposes of this cost application, it is assumed that ebullition of gases is not a significant performance issue.

The cost analysis for this scenario assumes that the full-scale site is ten acres in size, located on the East or West Coast, Upper Midwest or Gulf Region (logistics of shipping raw materials for local manufacture should not vary over 15% for this scenario). Approximately 4,900 tons of AquaBlok[®] would be required. The size of this project would justify local manufacture to eliminate packaging cost and minimize transportation costs. Although a mobilization cost for local manufacture would still apply, as would transport to the project site (assumed to be within five miles), the offsetting savings compared to packaging and transport from a remote manufacture site would more than offset costs to establish and support local manufacture.

Based on the dry bulk density of AquaBlok® 3070 FW, this “typical” scenario would require an application rate of approximately 22.5 lbs/ft². For purposes of this full-scale scenario evaluation, it is assumed that the application would be through 15 ft of water by barged-based conveyor (see Figure 4-1), with a supply barge(s) (see Figure 4-2) reloaded by a shore-based conveyor. A conveyor application has been demonstrated to be highly efficient for larger-scale applications.

An application rate of 500 tons per day is assumed for both the AquaBlok® and overlying sand material, which would require 20 days total application time. The Anacostia SITE demonstration pilot-scale application used 110 tons of AquaBlok® applied over three to four hours of actual construction time over a two-plus day period, with much of the intervening time spent in training, addressing field logistics, and holding strategic discussions. For reference, another AquaBlok® pilot program was completed using a clamshell with a larger bucket and a supply barge with a larger capacity than were used in the Anacostia project applying AquaBlok®, and, at a similar application rate, accomplished a 0.75 acre cap placement over approximately six hours total. QC for pilot purposes generally does necessitate a slower application rate than could be experienced on a full-scale application. Also, given the relatively short application time, it is assumed no additional costs for restricting or controlling access by boat traffic would be necessary. Based on monitoring completed during the Anacostia SITE project and other AquaBlok® applications, it is assumed that (unlike many dredging projects) additional controls to minimize and control turbidity and resuspension of sediment (e.g. silt curtains) would not be required.

It is also assumed that sufficient material would be manufactured ahead and stockpiled on-site so that after application is initiated, the process would continue through single (extended) day shifts until project completion.

4.2.3 Full-Scale AquaBlok® Application Cost Categories

4.2.3.1 General Cost Categories. Project costs for an AquaBlok®-based composite cap can be estimated for the following general categories:

- Material costs associated with local manufacture of AquaBlok® and purchase of sand;
- Installation costs, including equipment, labor, general overhead and profit;
- Construction QC and documentation; and
- Engineering design, permitting, contract and bid document preparation, and contract administration

4.2.3.1.1 Local AquaBlok® Manufacture Costs. A 10-acre capping project would justify local or near-site manufacture. Facility costs associated with such an activity would include a four-month lease period to cover set-up, raw material accumulation, and manufacture prior to and during actual application. In addition, mobilization of key manufacturing equipment and installation of the equipment and utilities would result in a cost, as would miscellaneous items such as insurance and security. While most manufacturing could reasonably be accomplished with local labor, a production supervisor and lead manufacturing QC personnel would incur travel and per-diem costs during the four-month period. Finally, transport costs for the local manufacture site are estimated based on a one-way transport distance of five miles and assuming a 20-ton payload. Table 4-1 includes estimated costs to cover these project components. For purposes of this analysis, it is assumed material costs are purchased directly by the project owner. If they are purchased by the installation contractor, they would typically be subject to a mark-up.

4.2.3.1.2 AquaBlok® Cap Installation Costs. Installation activities would include mobilizing appropriate construction equipment to



Figure 4-1. Typical Barge-Mounted Material Conveyor



Figure 4-2. Typical Material Barge

**Table 4-1. Cost Detail for “Typical” AquaBlok® Capping Project
(10-acre AquaBlok® Cap with Sand Cover)**

Item	Rate	Amount	Units	Cost
Materials				
facility lease/insurance/security	\$2,500	10	weeks	\$25,000
manufacturing setup/mobilization	\$125,000	1	lump sum	\$125,000
AquaBlok® manufacture	\$180	5,000	tons	\$900,000
Sand (delivered)	\$30	6,000	tons	\$180,000
AquaBlok® transport (5 mi)	\$70	250	loads	\$17,500
SUBTOTAL				\$1,247,500
Installation				
equipment mob/demob	\$150,000	1	lump sum	\$150,000
support trailer w/ utilities/security	\$1,000	5	weeks	\$5,000
equipment rental				
GPS	\$190	25	days	\$4,750
conveyor	\$788	10	weeks	\$7,880
backhoe	\$2,038	5	weeks	\$10,190
terrain loader	\$736	5	weeks	\$3,680
front-end loader	\$2,520	5	weeks	\$12,600
barges (2)	\$5,250	5	weeks	\$26,250
work boat	\$1,050	5	weeks	\$5,250
equipment fuel/maintenance				
conveyor	\$1,200	10	weeks	\$12,000
backhoe	\$1,600	5	weeks	\$8,000
terrain loader	\$800	5	weeks	\$4,000
front-end loader	\$1,800	5	weeks	\$9,000
work boat	\$2,500	5	weeks	\$12,500
labor				
conveyor operator	\$3,098	10	weeks	\$30,980
backhoe operator	\$2,113	5	weeks	\$10,565
terrain loader operator	\$2,033	5	weeks	\$10,165
front-end loader operator	\$2,112	5	weeks	\$10,560
work boat operator	\$4,988	5	weeks	\$24,940
general laborers	\$1,583	10	weeks	\$15,830
supervisor/foreman	\$1,699	5	weeks	\$8,495
SUBTOTAL				\$382,700
contractor				
bond/insurance		2%	equip/labor	\$7,655
overhead/profit		15%	equip/labor	\$57,405
SUBTOTAL				\$65,060
Construction Quality Control and O&M				
QC scientists (2)	\$10,000	10	weeks	\$100,000
final observation report	\$25,000	1	lump sum	\$25,000
miscellaneous expenses	\$2,000	1	lump sum	\$2,000
O&M (1-yr, 5-yr, and 10-yr)	\$10,000	3	events	\$30,000
SUBTOTAL				\$157,000
Engineering Design				
engineering design	\$120,000	1	lump sum	\$120,000
permits	\$30,000	1	lump sum	\$30,000
bid prep/contract administration		7%	installation	\$31,346
SUBTOTAL				\$181,300
TOTAL				\$2,034,000

Costs from RS Means, Putzmeister, vendor sources, and/or engineering estimates.

the project area, preparing a material laydown/unloading area, providing ramp access for work boats, providing site security and safety amenities as appropriate, and establishing a project trailer and utilities.

Equipment rental and labor costs to operate the equipment, including contractor overhead and profit, are also included in this category, as are all construction permits, access fees, bonds and contractors' insurance requirements.

As noted previously, it is assumed that application of the AquaBlok® and sand capping material could be accomplished at a base rate of one acre per day for each material, resulting in a five week period for a 10-acre site.

Following cap completion, an additional cost for demobilization and site restoration must be budgeted. For purposes of this analysis, demobilization costs are included in the mobilization cost estimate.

Insurance and bond fees are assumed to be an average of 2% of the total material and construction costs, and general overhead and profit are assumed to be 15% of the construction costs.

Equipment rental needs are assumed as follows:

- One front-end loader;
- Two mobile articulated/telescoping conveyors with hoppers (one barge-mounted for material application, one shore-based to load supply barges);
- One backhoe to load material from supply barge to application barge;
- One supply barge and one application barge; and
- One workboat to position barges

Specific construction labor personnel for the project are assumed to be as follows:

- Two conveyor operators;
- Three operators (backhoe, front-end loader, and terrain loader);

- Three work boat operators;
- Two miscellaneous laborers; and
- One supervisor/foreman

Specific production rates and a conceptual daily resource leveling schedule are provided on Figure 4-3, and resulting material and construction-related costs are detailed on Table 4-1.

4.2.3.1.3 Construction Quality Control and Documentation Costs. QC during installation is a fairly straightforward process which would consist of a team of scientists/technicians obtaining core samples on a periodic yet systematic basis, ascertaining dry and hydrated cap thicknesses, reviewing daily positioning data, compiling records, and at the end of the project preparing a final report. These professionals would incur travel, labor, and per-diem costs. In addition, the sampling crew would require the use of a small boat for the five-week installation period. Table 4-1 includes estimated costs to cover these project components.

4.2.3.1.4 Engineering Design, Permitting, Contract and Bid Document Preparation, and Contract Administration Costs. It is assumed that although a typical project would have already undergone a site investigation and experienced costs consistent with a remedial investigation (RI)/FS, additional engineering design would be required to establish construction parameters specific to the selected remedy; in this case, an AquaBlok®-based composite cap.

Typically, engineering design costs for an AquaBlok® cap would be incurred in establishing more detailed site bathymetry, particularly for QC and material pay quantity determinations and permit drawings. Relevant permits may include Clean Water Act (CWA) Section 404 and 401 permits/ certifications (see Section 2.11). Costs to prepare necessary bid and construction control documents and provide construction contract administration are estimated at 7% of the construction costs, which is a reasonable engineering assumption. Table 4-1

Activity	07:00	08:00	09:00	10:00	11:00	12:00	13:00	14:00	15:00	16:00
Setup and transportation										
Work boat operation										
Conveyor loaded by front-end loader										
Barge loaded by conveyor										
Conveyor loaded by backhoe										
Material moved by terrain loader										
Cap installed with conveyor										

Figure 4-3. Conceptual Daily Work Cycle for “Typical” AquaBlok® Capping Project (10-acre AquaBlok® and Sand Cap)

includes estimated costs to cover these project components.

4.2.3.1.5 Operations and Maintenance

Costs. A properly designed and installed AquaBlok® cap would require virtually no ongoing O&M activities or costs other than might be required as part of an extended QA/QC program. If the cap is appropriately designed to consider the sediment substrate bearing capacity, potential bioturbation, erosional forces (including recreational or commercial boating activities, scour, etc.) and chemical resistance, the inert and “geologic” nature of the prime components would provide extensive service.

An extended O&M activity for the cap would be to complete minimal site inspections at one-, five-, and perhaps ten-year intervals to ascertain the condition of the cap, potentially in conjunction with other monitoring programs (such as body burden analyses) that would likely be common to all major sediment remediation projects regardless of the remedy selected. Table 4-1 includes estimated costs to conduct a post-capping review at one-, five- and ten-year intervals. Due to the relatively low per-event costs and short overall duration of the O&M program, no net present value analyses were considered.

As with any remedy, if the cap were not designed to incorporate in situ degradation or permanent chemical treatment to render COCs harmless to the environment within a specified remedy life, more costs would be incurred for longer term site inspection.

Maintenance, where required, could be accomplished without significant effort if the cap were damaged in a small area by adding additional material to the area. As positive attributes of AquaBlok® include its ability to self-heal and self-compact, extensive maintenance would not be expected.

4.2.4 Full-Scale AquaBlok® Cap Installation Cost Analysis Summary

The material and installation cost for the assumed “typical” AquaBlok® cap placed over a 10-acre

site would be approximately \$1,695,260 (\$1,247,500 for AquaBlok® and sand, and \$447,760 for installation) for an average cost of \$3.90/ft². These costs are summarized in Table 4-1. Note that Table 4-1 provides all unit cost information to allow a basic comparison between the cost of a “typical” AquaBlok® cap and a sand-only cap, bearing in mind that the thickness, and accordingly volume, of a sand-only cap intended to accomplish the same RAOs as this “typical” AquaBlok® cap would likely be significantly greater (i.e., a sand-only cap may need to be 1 ft or more thick).

A summary of costs in component square foot and percentage of total project cost, including construction QC, engineering design, permitting and contract administration, is provided as follows:

<u>Component</u>	<u>Cost/ft²</u>	<u>% Project Total</u>
AquaBlok®	\$2.45	52
sand	\$0.41	9
installation	\$1.03	22
construction QC	\$0.36	8
design/permitting	\$0.43	9
TOTAL	\$4.68	100

While the costs for this “typical” capping scenario and the real costs incurred during the SITE demonstration can be used as a reasonable basis to demonstrate a site-specific range of costs for any given project, the reader is reminded that, as with any project, costs will vary on the basis of project-specific factors.

The assumed “typical” scenario is neither conservative nor liberal as a representative project. For example, if a significant portion of the area could be reached from shore using a conveyor approach, application rates could be lower and produce significantly lower costs. Similarly, a larger project and favorable terrain might support the construction of a simple chute to load supply barges directly from the shore without the need for a conveyor and operator for this purpose. If a project is located in a major port area where larger supply barges can be mobilized effectively, the application time for the assumed 10-acre site could be reduced significantly using the same level of equipment

and labor, with corresponding reductions in equipment rental and labor cost.

Material costs could increase significantly if remote manufacture is not appropriate and packaging and long-haul shipping are required. In addition, other freshwater blends and saline blends of AquaBlok® are more expensive than the “typical” 3070 FW material considered. Similarly, the use of AquaBlok Gate™ or AquaBlok+™ (see Appendix A), which can provide in situ chemical treatment of contaminated sediments, could increase material costs by 20-40%. The cost of an organoclay modified AquaBlok® can be even greater.

Conversely, the use of a lesser thickness of AquaBlok® (and more sand), or the use of an AquaBlok Blended Barrier™ approach (see Appendix A) could significantly reduce material costs (by as much as 40%).

Finally, as with any technology, the maturation of the AquaBlok® technology and its potential selection and performance at contaminated sediment sites over time would most certainly lead to free market impacts of supply and demand that could ultimately influence its cost. The precise impact of free market forces on unit cost for deployment of AquaBlok® cannot be predicted, but it is likely that if this approach were to become used more commonly, costs would be driven down.

It is anticipated that lower equivalent material costs, mobilization costs and shipping costs would be experienced, as with most new technologies, at a point after multiple applications were completed and economics of scale of manufacturing and distribution realized, including on-site production. Similarly, if different AquaBlok®-based designs are implemented and used in conjunction with other materials for a wider range of application goals, it is likely that overall AquaBlok® costs would come down. The tendency to overdesign (i.e. thicker than necessary cap layers), due to lack of experience, could continue to contribute to higher costs in the near term, but as hypothetically more projects are deemed successful, designers and engineers will undoubtedly push the design envelope to provide

solutions relying on minimal product or leaner mixtures that result in ultimately acceptable remedies. The Blended Barrier™ approach (see Appendix A) of blending AquaBlok® with specifically sized untreated aggregate (obtained in the locale of the project) to provide a lower permeability barrier is a clear example of improvements to the technology that could result in overall lower project costs by using the main AquaBlok® product in a more efficient manner, where warranted.

Finally, as the demand for material becomes more consistent and continuous, with multiple larger projects or repeated smaller projects, AquaBlok, Ltd. would likely develop customized equipment for more efficient production of products. The development of new application techniques by the construction industry in general can accomplish installation more simply, with more uniform and efficient applications, perhaps further reducing material needs while also resulting in lower installation and QA/QC costs.

Section 5 Demonstration Conclusions

The overall performance of AquaBlok® as an innovative contaminated sediment capping technology was evaluated in the context of three primary SITE demonstration program study objectives through an extensive field assessment program implemented in the Anacostia River in Washington, DC over the course of approximately three years. Four individual field sampling events were conducted (i.e., one, six, 18, and 30 months following cap construction), and a multitude of individual sampling tools and monitoring devices were utilized.

The data generated during the SITE demonstration suggest that AquaBlok® material is highly stable. Oceanographic surveying (i.e., bathymetry and side-scan sonar surveying) indicated that the AquaBlok® cap was not substantially physically altered in any way during the three year evaluation period. In fact, over the course of the demonstration, it appears that fine, organic-rich new sediment was deposited in the demonstration area, effectively increasing the overall thickness of the sediment caps, albeit slightly and generally at a magnitude consistent with the inherent resolution of the oceanographic measurement tools. In the specific demonstration area environment, the sand-only cap and even native sediments were generally physically unaffected during the course of the demonstration, which would suggest that AquaBlok® may not have a distinct advantage in this particular environmental setting and relative only to the measure of physical stability provided by oceanographic surveying. SPI data as well as sediment coring and laboratory physical parameter data further confirmed the integrity of the AquaBlok® and sand capping materials in the specific demonstration area environment by demonstrating a consistent grain size distribution versus depth in the capped areas. However, Sedflume analyses conducted during the

demonstration indicate that AquaBlok® is more resistant to shear stress compared to traditional sand capping material. Moreover, the Sedflume data indicate that AquaBlok® is a highly competent material and is unlikely to be eroded even at very high shear stresses consistent with very high flow conditions that are uncharacteristic of the generally sluggish Anacostia River demonstration area environment.

COC data generated during the sediment coring suggest there was ongoing deposition of new sediment on the capping cells that contained contamination. The sediment coring data suggest that newly deposited sediment in the Anacostia River contained detectable levels of all of the primary COC classes, which is not surprising given the location of the site in a highly urbanized/industrialized portion of Washington, DC. The specific source of this contamination was not studied (e.g., suspended sediment from areas outside the demonstration area being deposited in the study area through natural hydrodynamics in the river, inputs from ongoing diffuse urban pollution, and/or redeposition of sediment suspended during actual capping activities).

In addition, there may have been some relatively minor increased rate of contaminant flux from the underlying native sediment into the basal portion of the sand cap as compared to the AquaBlok® material, as evidenced by generally higher and more consistently detectable concentrations of PAHs and PCBs at the base of the sand cap compared to the base of the AquaBlok® cap. However, this observation was not specifically verified using statistical testing, and given the generally very low levels of contamination present in the basal portion of the sand and AquaBlok® capping materials, this conclusion is not necessarily indicative of variability in the potential

for contaminant movement upward through the two cap types. In addition, this observation is somewhat complicated with respect to metals and the possibility that AquaBlok[®] material preferentially sorbs metals and/or itself contains metal constituents dependant on its source material (i.e., the particular clay used to manufacture the product). Given the strong sorption capacity of AquaBlok[®] material, it may also bind certain organic and inorganic contaminants. Alternatively, given its strong sorption capacity, and assuming contaminant flux into both AquaBlok[®] and sand were occurring, AquaBlok[®] may be more effective at preventing the subsequent breakthrough of contamination and exposure of sensitive ecological or human receptors.

The gas flux data generated through the SITE demonstration, while limited in utility due to several field deployment and retrieval issues and the likely inability to capture all potential vapor phase flux across the study area, appear to indicate that AquaBlok[®] is characterized by little to no net flux through gas ebullition while the traditional sand capping material is characterized by at least some flux. In addition, it appears at least plausible that AquaBlok[®] is capable of retarding the movement of certain vapor phase (i.e., sulfur-based) compounds while this same effect was not observed for sand. While a quantitative analysis of gas flux data was accomplished, it is noteworthy that the gas flux study design could not have captured all gas ebullition potentially occurring in the study area and may have specifically not targeted areas where increased gas ebullition was occurring, and should therefore be evaluated in the context of this significant uncertainty.

In terms of the ability of AquaBlok[®] to prevent seepage, hydraulic conductivity measurements indicate AquaBlok[®] is highly impermeable and far more impermeable relative to traditional sand capping material, which is not surprising given the very different grain-size composition of these two capping materials. In addition, while the data suggest AquaBlok[®] is characterized by hydraulic conductivities generally similar to those in native Anacostia River sediments, it appears likely that the intrinsic permeability of AquaBlok[®] is lower

than the native sediments given the greater potential for preferential flow paths in native sediments related to biogenic activity and the claimed ability of AquaBlok[®] to heal. Seepage meter testing generally confirms this conclusion, with visual evaluation of the data indicating that aqueous flux through AquaBlok[®] was lower than through traditional sand capping material. Moreover, aqueous seepage through AquaBlok[®] was determined to be, on average, vertically downward from surface water to sediment as opposed to from sediment to surface water (i.e., as with sand). The seepage meter data actually appear to potentially indicate that traditional sand capping material may have acted in some way to exacerbate fluid flow through sediment during the demonstration, although no mechanism for this effect was directly observed or studied, and this observation may actually have been an artifact of fluid flow diversion from beneath the AquaBlok[®] cap to the adjacent sand cell. Overall, the seepage data did not exhibit a statistical trend that clearly indicated a difference between the performance of AquaBlok[®] and sand, but the weight of evidence gathered through the demonstration (including an evaluation of the seepage data from a purely empirical perspective) does appear to suggest AquaBlok[®] would be a more effective barrier to fluid flow.

With respect to benthic ecology, the surface sediment environment within the tidally influenced freshwater environment at the site appeared to be controlled by physical processes and did not appear to support a highly structured benthic community. Biogenic activity, therefore, did not appear to be a factor, negative or positive, in cap longevity. Accordingly, SPI data were of only limited power in directly understanding ecological recovery rates or impacts of capping material on benthic communities. Benthic organisms in the system appeared from the SPI imagery to have been dominated by very small oligochaetes. Specific assays and statistical evaluation of benthic habitats and faunal communities in the AquaBlok[®] and sand cells indicated that small deposit-feeding organisms were dominant in the demonstration area and that the AquaBlok[®] and sand cells were more similar to each other than the control cell in terms of ecology. However, ecological assemblages in the AquaBlok[®] and

sand cells retained differences that clearly separated them from each other. In particular, AquaBlok® demonstrated relatively equal or greater abundances of individuals within the major taxonomic groups found to also occur in the sand capping material in the sand cell. This could be taken to indicate that the AquaBlok® cell was a more suitable habitat for benthic recolonization, perhaps by providing a more effective barrier against porewater contaminant flux into surficial sediments where most benthos occur, or by being a more similar grain size relative to existing native sediments. However, the AquaBlok® cell was covered by a sand layer, and the benthic sampling was conducted in surface sediments. It is therefore difficult to infer from the available data what impact AquaBlok® itself had on benthic recovery as the benthic comparisons were essentially between the same cap material (i.e., sand in the sand cell and sand covering material in the AquaBlok® cell). It can, however, be inferred from the data generated that AquaBlok® does not appear to have a detrimental effect on benthic recovery.

The SITE demonstration of the AquaBlok® technology was designed to answer fundamental questions about its performance relative to more traditional sediment capping material. In answering these questions, a significant amount of data collection and data analysis were conducted. While the data collection and data analysis were robust and appropriate, the data were not necessarily evaluated in every fashion possible. In addition, there are obvious field data collection issues and inherent data uncertainties that limit the usefulness of certain data and the power of certain evaluations and interpretations, and the conclusions of the demonstration must be reviewed in that context.

The results of the SITE demonstration do open for consideration several complimentary lines of questioning and potentially beneficial avenues of further study. For instance, additional study may be warranted to determine if AquaBlok® is susceptible to significant failure from the buildup of gas pressure and subsequent short-circuiting through preferential pathways or catastrophic gas releases. In addition, it is possible that AquaBlok® material could act to divert

contaminant flux (fluid or vapor phase) to the periphery of a capped area, potentially biasing and concentrating the flux of contamination in discrete locations even beyond the original contaminant footprint (note there are sites where a net neutral flux could be the equilibrium condition, meaning that an impermeable cap would likely not lead to lateral contaminant diversion; also, as described in Appendix A, there are commercially available forms of AquaBlok® or formulations in development that could potentially counteract the lateral diversion of contaminant flux by integrating reactive components or “funnel and gate” concepts). Ice scour and freezing conditions are generally acknowledged to be a potential limitation of sediment capping alternatives, and understanding the full effect of ice-related conditions on an AquaBlok® cap could be a critical developmental need. Moreover, a more complete understanding of benthic recovery would likely be gained by assessing community structure over more time than three years, and potentially by assessing an AquaBlok®-only cap instead of a sand covered AquaBlok® cap. It was not an objective of the SITE demonstration to evaluate these potential phenomena.

Section 6 References

- Alcoa. 2007. Grasse River information. Available at: <http://www.thegrasseriver.com>.
- Anacostia Watershed Society. 2007. Anacostia River information. Available at: <http://www.anacostiaws.org>.
- Battelle Memorial Institute (Battelle). 2004. *Quality Assurance Project Plan for the SITE Demonstration of the AquaBlok® Sediment Capping Technology at the Anacostia River, Washington, DC*. Prepared for EPA NRMRL. March.
- Clarke, K.R. and R.M. Warwick. 2001. *Change in Marine Communities: An Approach to Statistical Analysis and Interpretation*. Plymouth Marine Laboratory, Plymouth, UK 859 p.
- Diaz, R.J. and L.C. Shaffner. 1988. "Comparison of Sediment Landscapes in the Chesapeake Bay as Seen by Surface and Profile Imaging." M.P. Lynch and E.C. Krome, eds., *Understanding the Estuary: Advances in Chesapeake Bay Research*. Chesapeake Research Consortium Publication 129, CBP/TRS 24/88. pp. 222-240.
- Gailani, J.Z., L. Jin, J. McNeil, and W. Lick. 2001. "Effects of Bentonite on Sediment Erosion Rates." DOER Technical Notes Collection (ERDC TN-DOER-N12), U.S. Army Engineer Research and Development Center, Vicksburg, MS. Available at: www.wes.army.mil/el/dots/doer.
- Horne Engineering Services, Inc (Horne). 2004. *Revised Draft Cap Completion Report for Comparative Validation of Innovative "Active Capping" Technologies, Anacostia River, Washington, DC*. Prepared for HSRC. December.
- Hull & Associates, Inc. 2002. *Summary Report of the Ottawa River AquaBlok® Application Demonstration*.
- Hurlbert, S.H. 1971. "The Nonconcept of Species Diversity: A Critique and Alternative Parameters." *Ecology* 52:577-586.
- Ludwig, J.A. and J.F. Reynolds. 1988. *Statistical Ecology: A Primer on Methods and Computing*. John Wiley & Sons, New York, New York.
- May, R.M. 1975. "Patterns of Species Abundance and Diversity." M.L. Cody and J.M. Diamond, eds., *Ecology and Evolution of Communities*. Belknap Press, Cambridge, MA, pp. 81-120.
- McNeil, J., C. Taylor, and W. Lick. 1996. "Measurements of Erosion of Undisturbed Bottom Sediments with Depth." *Journal of Hydraulic Engineering* 122(6): 316-324.
- Mermillod-Blondin, F., M. Gerino, V. Degrange, R. Lensi, J.L. Chasse, M. Rard, and M.C. des Chatelliers. 2003. "Testing the Functional Redundancy of *Limnodrilus* and *Tubifex* (Oligochaeta, Tubificidae) in Hyporheic Sediments: An Experimental Study in Microcosms." *Canadian Journal of Fisheries and Aquatic Sciences* 58(9):1747-1759.
- Paulsen, R.J., C.F. Smith, D.E. O'Rourke, and T. f. Wong. 2001. "Development and Evaluation of an Ultrasonic Groundwater Seepage Meter." *Groundwater* Nov-Dec Vol. 39 No. 6: 904-911.

-
- Pielou, E.C. 1966. "Species Diversity and Pattern Diversity in the Study of Ecological Succession." *Journal of Theoretical Biology* 10:370-383.
- Rhoads, D.C., and J.D. Germano. 1986. "Interpreting Long-Term Changes in Benthic Community Structure: A New Protocol." *Hydrobiologia* 142: 291-308.
- Roberts, K.L. 2004. "Modeling of River Hydrodynamics and Active Cap Effectiveness in the Anacostia River." Master's Thesis. Louisiana State University.
- Sanders, H.L. 1968. "Marine Benthic Diversity: A Comparative Study." *American Naturalist* 102:243-282.
- U.S. Geologic Survey (USGS). 2006. River stage information. Available at: <http://waterdata.usgs.gov/nwis>.
- U.S. Environmental Protection Agency (EPA). 2000. "Field-Scale Testing of a Composite Particle Sediment Capping Technology." *Tech Trends* February.
- U.S. Environmental Protection Agency (EPA). 2006. *Lower Fox River/Green Bay Site Technical Memorandum, Current Plan and Proposed Plan*. November.
- Wang, X-S. and G. Matisoff. 1997. "Solute Transport in Sediments by a Large Freshwater oligochaete, *Branchiura sowerbyi*." *Environmental Science & Technology* 31(7):1926-1933.
- Yuan, 2007. "Experimental and Modeling Studies of Contaminant Transport in Capped Sediments during Gas Bubble Ebullition." PhD Dissertation. Louisiana State University.