

**Built-in 3.5" TFT LCD
Color Display**

**Stand-alone or PC-
connected operation**

10 Analog Channels

**Input-to-output &
channel-to-channel
Isolation**

USB PC Interface

With its color monitor and internal memory the GL200A is a compact, lightweight, multi-channel data logger that provides 10 analog measurement channels, in addition to one channel each of discrete logic and pulse inputs. The GL200A also supports one external trigger input and one alarm output. The GL200A is equipped with a 3.5 MB internal flash memory to allow the direct capture of acquired data, and its built-in USB port may be used to connect any standard USB flash drive for incremental capacity. Alternatively, the USB interface may be connected to a PC to allow data upload in real time or from memory, as well as remote configuration and real time data acquisition.

Wide Voltage Measurement Range

Each GL200A analog channel can measure from 20 mV to 50 VFS across eleven programmable measurement ranges.

Full Electrical Isolation Per Channel

Each analog GL200A channel is electrically isolated from all others and from instrument ground to allow accurate and safe measurements in industrial applications where ground potential differences are common.

Humidity Measurements

Use the GL200A to measure humidity with an optional sensor.



Features

Voltage, Current, and Temperature Measurements

Use the GL200A to measure voltages, currents, 4-20 mA process currents, as well as thermocouple-based temperatures.

One Pulse Input for Speed and Counting Measurements

The GL200A provides one discrete input channel that can be used for counting and rotational speed measurement applications.

Real Time and Post-recorded Calculations

The GL200A may be programmed to calculate average value, peak value, minimum value, and rms.

One Alarm Output

Program the GL200A to trigger its alarm output as a function of analog input signal level judgment, pulse judgment, or logic pattern.

Wide Sample Interval Selections

Sample intervals can be programmed to be one of sixteen values ranging from 100 ms to one hour.

Bright TFT LCD Color Display

The focal point of the GL200A is its 3.5" built-in color display that allows real time trending, data review, and complete instrument configuration.

Engineering Units Scaling

Each GL200A channel allows up to four break points to be programmed for accurate scaling into meaningful units like psi, grams, newtons, gallons per minute, etc.

One Discrete Input for Logic Measurements

Use the GL200A to measure the binary status of any external system.

Flexible Triggering Options

The GL200A allows data capture to be started or stopped based upon signal level, an external event, date/time, alarm, duration, or Boolean channel combinations. Analog signal triggers can be programmed based upon level and window tests: above threshold, below threshold, inside window, or outside window.

Flexible Power Requirements

Power the GL200A from its provided international AC adaptor, from an optional built-in battery pack, or from any 9 to 24 VDC source using an optional cable.

PC Connectivity and Memory Expansion via USB Interface

Allows data transfer to the PC either in real time or from the GL200A's memory. Also allows complete configuration of the GL200A. Connect any standard USB Flash Drive to the USB port for external memory expansion.

PC Software Bundle Included

The GL200A includes a Windows application for direct capture, measurement, and monitoring of GL200A data. In addition to waveform and data value capture and display, the application can export data to an Excel file for further analysis and report creation. The software includes built-in help for quick reference.

GL200A Display, I/O, and Control Overview

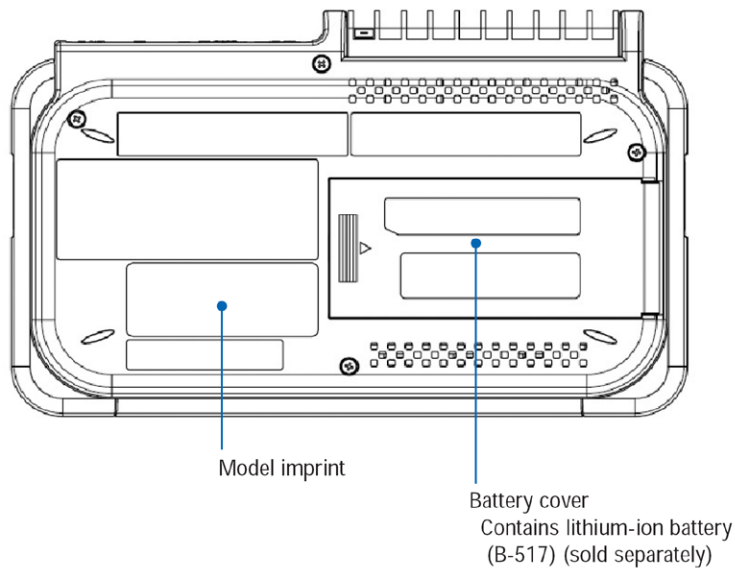
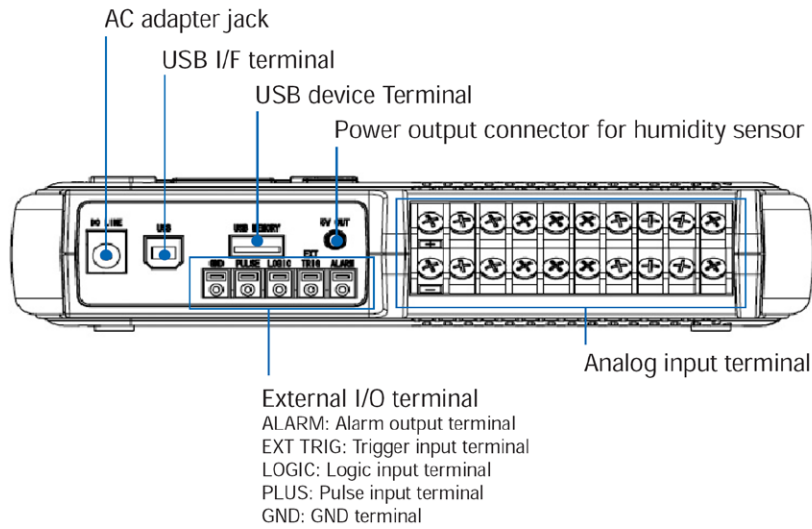
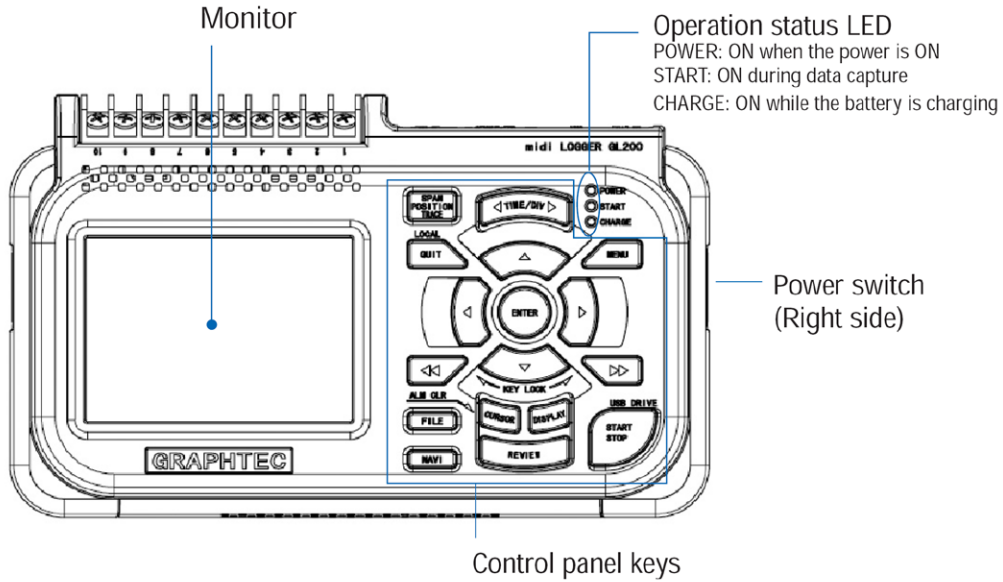

GL200A Analog Input Circuit and Measurement Ranges

Each GL200A analog input channel features electrical isolation using a photo MOS relay switching method to maintain safe and accurate measurements in demanding industrial environments.

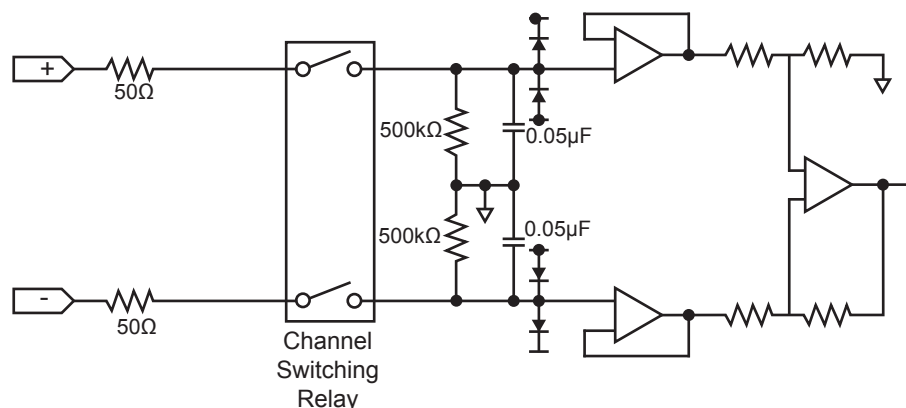

Voltage Measurement Ranges per Channel

Range	Maximum SPAN	Minimum SPAN	Minimum Resolution
20mV	-22.000 to +22.000mV	0.200mV	0.001mV
50mV	-55.00 to +55.00mV	0.50mV	0.01mV
100mV	-110.00 to +110.00mV	1.00mV	0.01mV
200mV	-220.00 to +220.00mV	2.00mV	0.01mV
500mV	-550.0 to +550.0mV	5.0mV	0.1mV
1V	-1.1000 to +1.1000V	0.0100V	0.0001V
2V	-2.2000 to +2.2000V	0.0200V	0.0001V
5V	-5.500 to +5.500V	0.050V	0.001V
10V	-11.000 to +11.000V	0.100V	0.001V
20V	-22.000 to +22.000V	0.200V	0.001V
50V	-55.00 to +55.00V	0.50V	0.01V

Process Current Measurement (with external 250-ohm resistor)

Range	Maximum SPAN	Minimum SPAN	Minimum Resolution
1-5 V	-5.500 to +5.500V	0.050V	0.001V

Temperature Measurement Ranges per Channel (note no RTD measurements)

Range	Maximum SPAN	Minimum SPAN	Measurement Range	Minimum Resolution
K	-270 to +2000°C	50°C	-200 to +1370°C	0.1°C
J			-200 to +1100°C	
T			-200 to +400°C	
R			0 to +1600°C	
E			-200 to +900°C	
B			+600 to +1920°C	
S			0 to +1760°C	
N			0 to +1300°C	
W			0 to +2315°C	

Optional Humidity Measurement Range

Range	Maximum SPAN	Minimum SPAN	Minimum Resolution
0 to 100%	0 to +110%	1.0%	0.1%

Typical GL200A Analog Signal Connections

Terminal Configuration

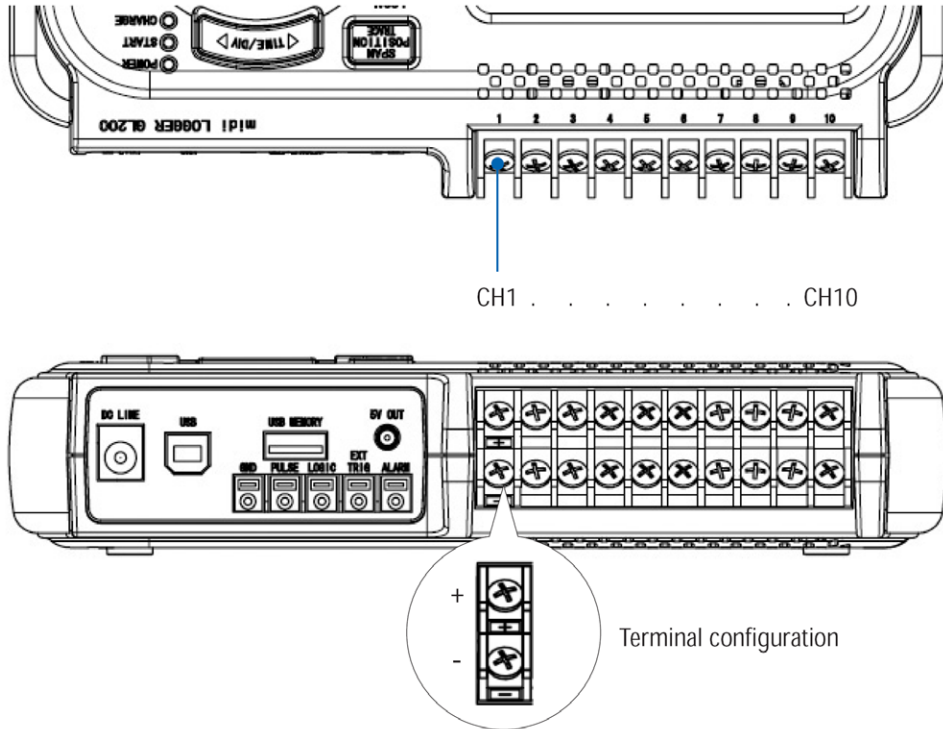

For current in the 4 to 20mA Range, apply a resistance to 250 Ω and perform measurement in the 1-5V range.

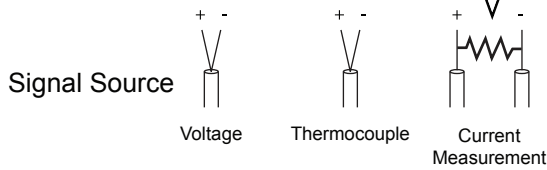

- + High -voltage terminal (terminal for high voltage signals)
- Low-voltage terminal (terminal for low-voltage input signals)

Item	Description
Input configuration	Isolated input, scanning
Analog voltage	20, 50, 100, 200, 500 mV/F.S.; 1, 2, 5, 10, 20, 50, V/F.S.; 1-5V
Thermocouples	K, J, E, T, R, S, B, N, W (WRe 5-26)
A/D resolution	14-bit
Filter	Off, 2, 5, 10, 20, 40 Filter operation is on a moving average basis. The average value of the set sampling count is used.

Usable Channels at Different Sampling Speeds						
Sampling Speed:		10ms	20ms	50ms	100ms	1s
Number of usable channels:		1	2	5	10	10
Measurement phenomenon	Voltage:	•	•	•	•	•
	Temperature:				•	•

Program the GL200A for Real-World Trigger Conditions

The GL200A can adapt to just about any trigger condition you might encounter. Data recording can be stopped or started as a function of analog signal level, a definable alarm condition, an external event, or specific date and time. Beyond initiating a data capture cycle, the GL200A can also be programmed to set a digital output to flag an external alarm condition. And after a trigger condition is executed you can program the GL200A to automatically rearm itself to wait for another trigger event, or stop entirely. You can even program the GL200A to detect and alarm on a thermocouple burnout condition. Here's a summary of the GL200A's trigger and alarm features:

GL200A Trigger and Alarm Overview

Setting	Selections Available
Start side source setting	Off, Level, Alarm, External Input, Date
	Level: Mode, Level, Combination
	Alarm: Alarm port number
	External input: none
	Date: Date, Time
Stop side source setting	Off, Level, Alarm, External Input, Date, Time
	Level: Mode, Level, Combination
	Alarm: Alarm port number
	External input: none
	Date: Date, Time
	Time: Duration
Repeated capturing	On, Off
Alarm level settings	Mode, Level, Output
Alarm hold	On, Off
Send burnout alarm	On, Off

GL200A Trigger Modes

Above Threshold

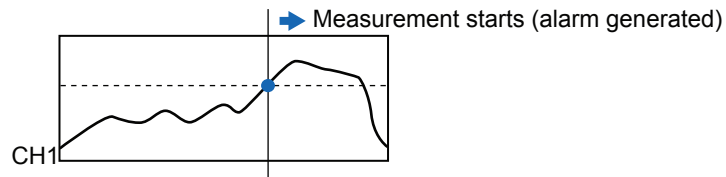

Below Threshold

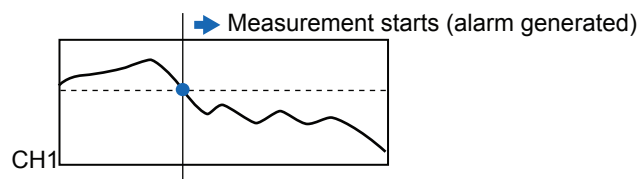

Inside Window

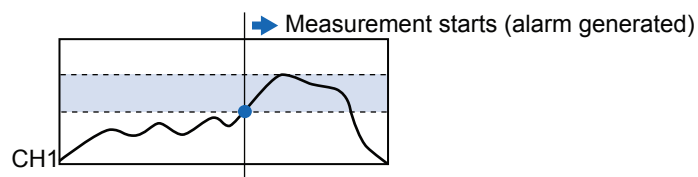

Outside Window

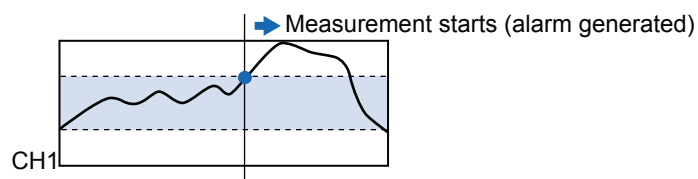

GL200A Logic, Pulse, Alarm, and External Trigger Connections

A terminal strip on the rear of the unit provides access to the GL200A's discrete and pulse inputs, external trigger input, and alarm output.

Pulse Input Connections

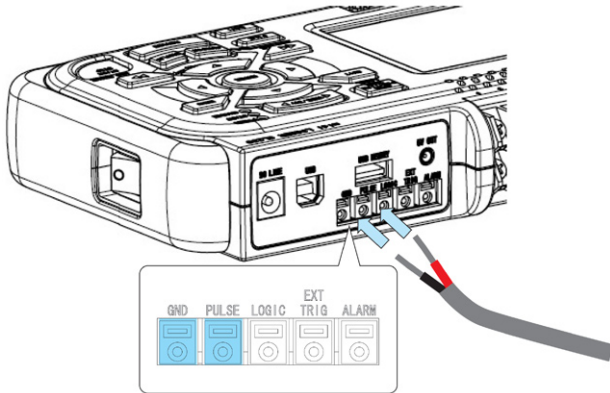

Item	Description
Number of channels	1
Input voltage range	0 to +24V max (single-ended ground input)
Threshold level	+2.5V
Hysteresis	Approx. 0.5V (+2.5 to +3 V)

Discrete Input Connections

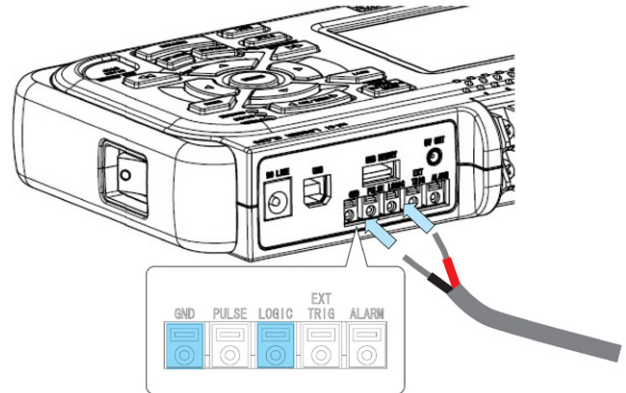

Item	Description
Number of channels	1
Input voltage range	0 to +24V max (single-ended ground input)
Threshold level	+2.5V
Hysteresis	Approx. 0.5V (+2.5 to +3 V)

External Trigger Connections

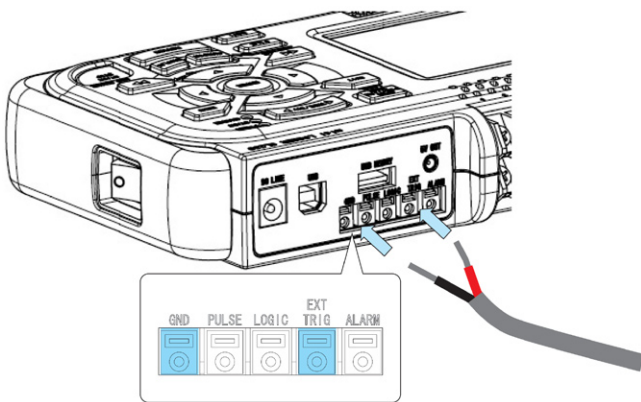

Item	Description
Number of channels	1
Input voltage range	0 to +24V max (single-ended ground input)
Threshold level	+2.5V
Hysteresis	Approx. 0.5V (+2.5 to +3 V)

Alarm Connections

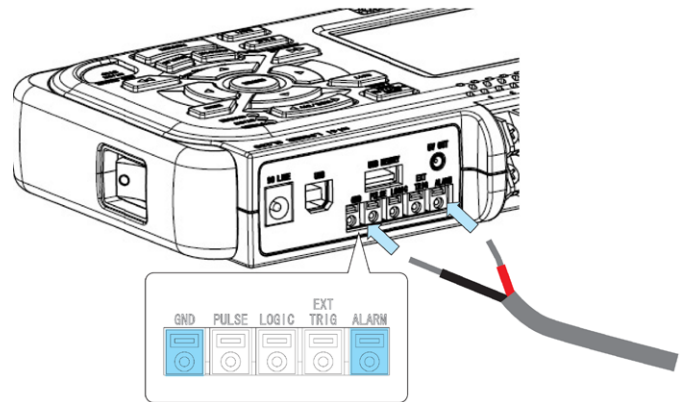

Item	Description
Number of channels	1
Maximum rating	VCEO (voltage between connector and emitter): 30V IC (connector current): 0.5A

Alarm Output Circuit

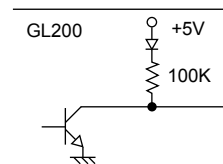

Maximum rating

VCEO (voltage between connector and emitter) : 30V
IC (connector current) : 0.5A
PC (connector lost) : 0.2W

Note: be sure to not exceed the maximum ratings.

External Memory and USB Connections, and an Optional Battery Pack

The GL200A provides the added benefit of PC connectivity to its USB port, which doubles as a method to expand the GL200's internal 3.5 MB memory using standard USB flash memory. Flash drives may be hot-swapped as they fill to accommodate long term measurements. When the USB port is connected to a PC you can upload measurement protocols to the GL200A, monitor acquired data in real time, or download previously acquired data. Up to ten GL200A's may be simultaneously connected to one PC through USB hubs (there is no synchronization between units). Finally, an optional battery pack may be added to the GL200A to allow power-independent data recording whenever and wherever it's required.

USB Flash Drive Memory Expansion

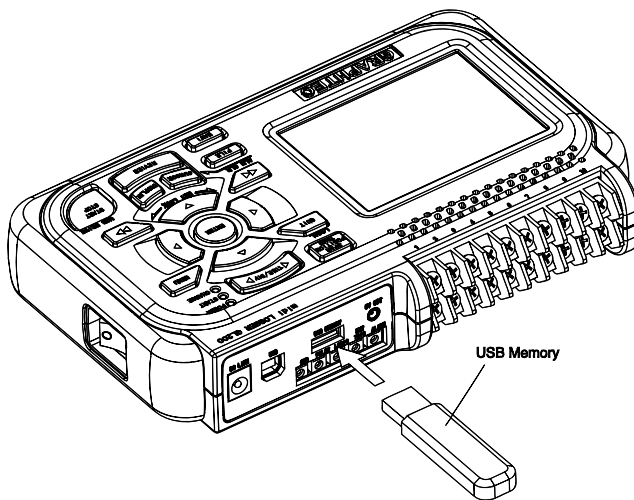

USB-to-PC Interface Connection

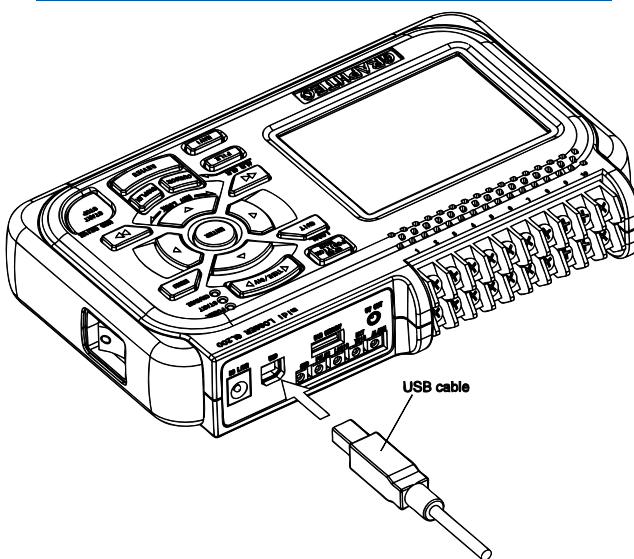

Optional B-517 Battery Pack

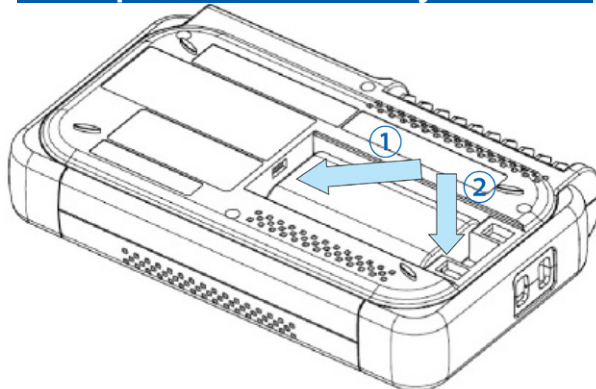

GL200A Display Quick-look

The GL200A's keyboard and display are key components you'll use for any typical data recording session. The display is a full color TFT LCD (thin-film transistor liquid crystal display), the same technology used in modern flat-panel televisions. The display measures 3.5 inches diagonally, and offers 320 x 240 pixels of bright, clear, high contrast resolution. The GL200A's keyboard allows full access to the instrument's menu system as viewed through its display. Navigation is straightforward and intuitive using the keyboard's navigation and ENTER keys that form the center of the array. Other keys support special operations that are clearly annotated.

GL200A Display Close-up and Modes

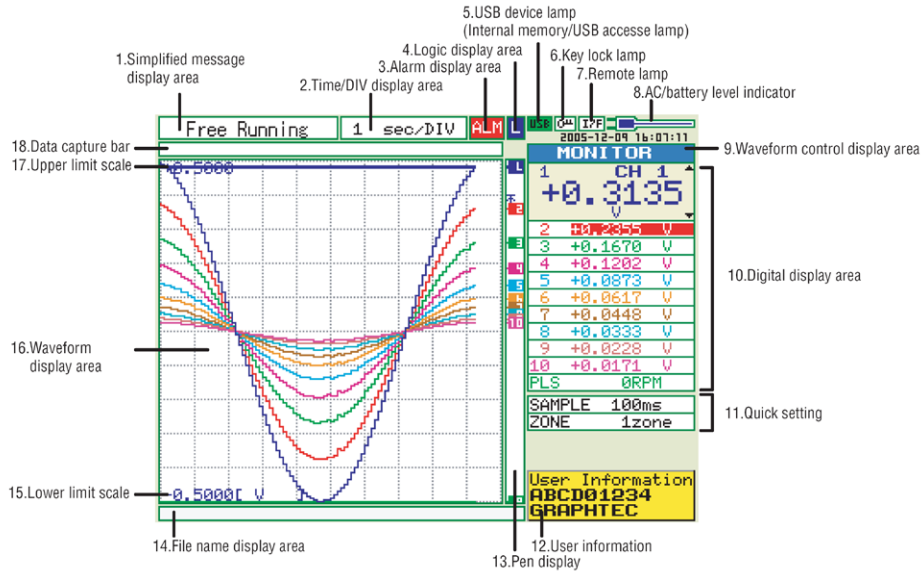

MONITOR

AMP settings

Level settings

Digital screen

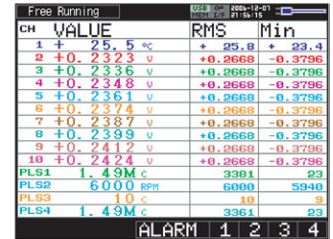
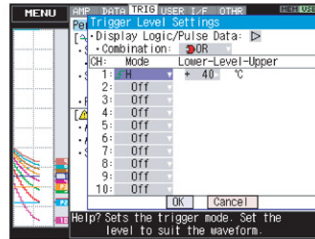
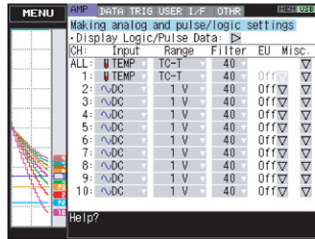
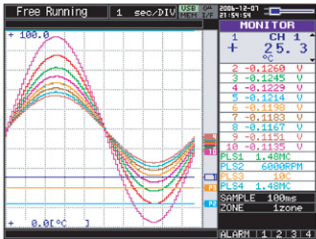

Keyboard Close-up

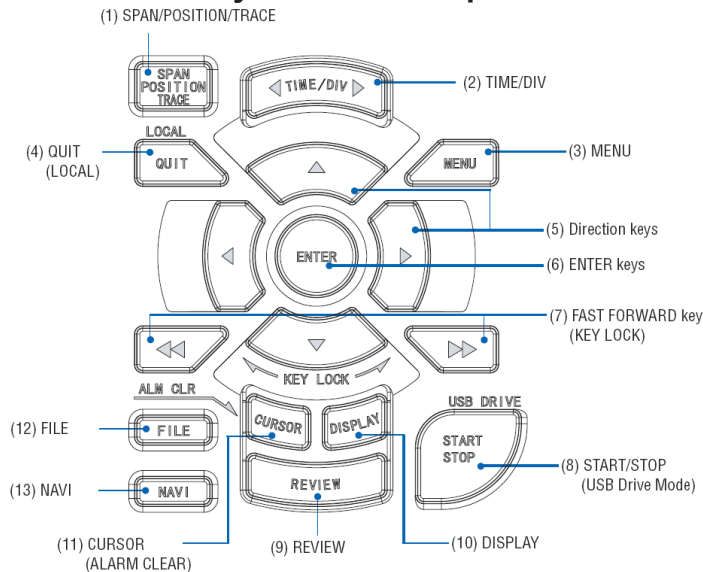

GL200A Included and Optional Accessories

Included PC Software

Item	Description
Compatible OS	Windows 2000, Windows XP
Functions	Main unit control, real time data capture, data conversion
Main unit settings	Input, memory, alarm, trigger
Captured data	Real time data (CSV, Binary), Memory data, USB memory data
Display	Analog waveforms, logic waveforms, pulse waveforms, digital values
Display modes	Y-T, X-Y, Digital, Meter, Report
File conversion	Between cursors. All data.
Monitor functions	Alarm monitor enables sending of e-mail to the specified address
Dual-screen function	Displays the current data alongside past data
Report function	Automatic creation of daily or monthly files
Maximum/Minimum	The maximum, minimum and current values are displayed during measurement.

Included Accessories

Item	Description
Quick Start Guide	GL200A-UM-85x
CD-ROM	User's manual, application software
AC cable/AC adapter	100 to 240 VAC, 50/60 Hz

Optional Accessories

Item	Option No.	Description
Battery pack	B-517	7.2V/2200mAh
DC power cable	B-514	Bare tips (2 m)
Humidity sensor	B-530	3m, with dedicated power connector
Carrying Case	B-536	Durable carrying case designed specifically for the GL200A

Optional Battery Pack model B-517

Item	Description
Capacity	7.2V/2200mAh; mounted in the main unit
Battery type	Lithium secondary battery
Running time	When using LCD display: approx. 5 hours When using screensaver: approx. 6 hours
Charging method	Mount in the main unit, or use a separate battery charger (if mounted in the main unit power switch must be turned off)
Time required for charging	Main unit: approx. 4 hours
Switchover in the case of power failure	Because the battery is used together with the AC adapter, the power supply will be switched automatically to the battery in the event of power failure. The AC adapter is the primary power source
Operating environment	15 to 40°C
Other functions	When battery is running low, file is saved and closed automatically (when captured to USB or internal memory).

Optional Humidity Sensor model B-530

Item	Description
Allowable temperature range	-25 to 80°C
Allowable Humidity Range	0 to 100%
Relative humidity measurement accuracy	±3% RH (5 to 98% RH at 25°C)
Response time	15 s (90% response when membrane filter installed)
Sensor output	0 to 1 VDC
Sensor power source	5 to 16 VDC
Power consumption	approx. 4mA
External dimensions	14mm × 80 mm (excluding cable)
Cable length	3m

GL200A External Dimensions

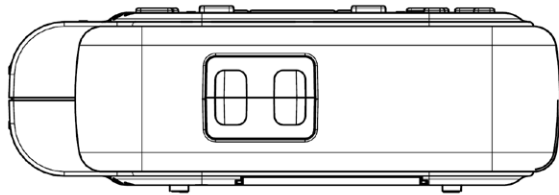
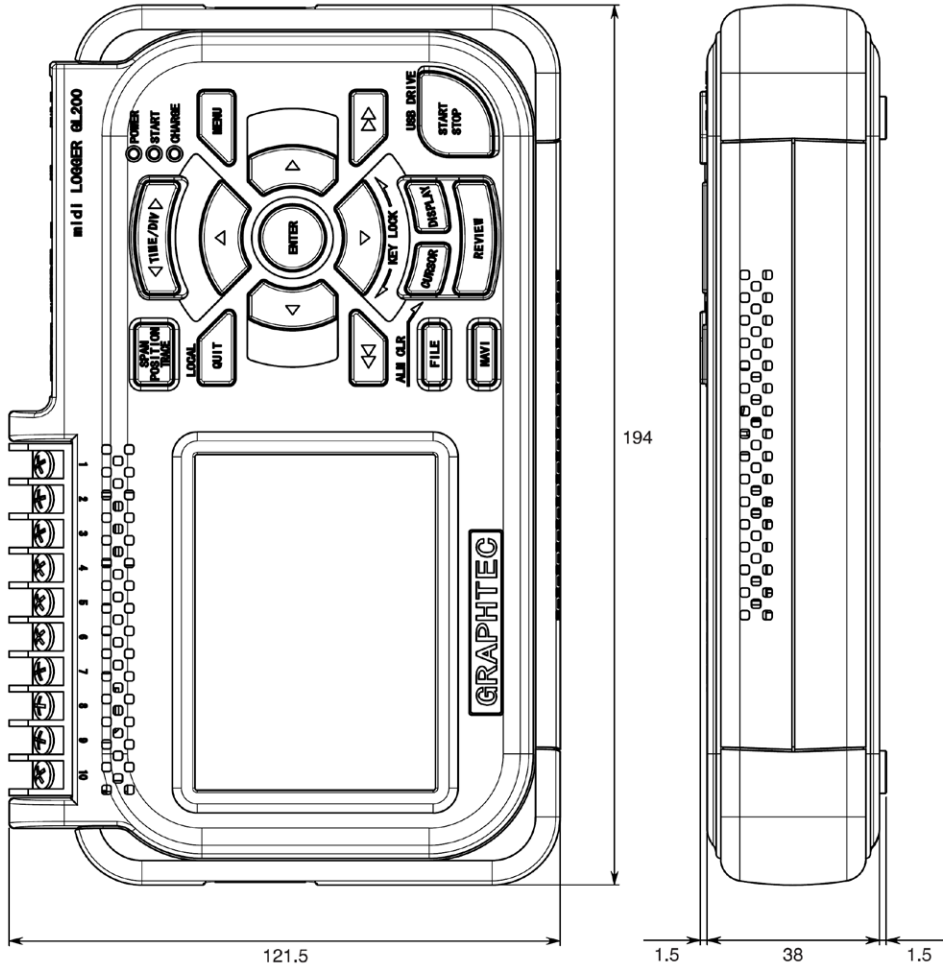
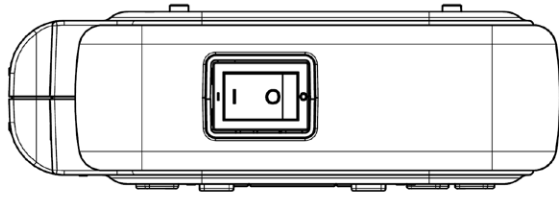

Dimensional precision: ± 5 mm
Unit: mm

GL200A Specifications

Overall Specifications

Number of analog inputs: 10 channels

External input/output: Trigger input, Logic input, Pulse input, Alarm output

PC interface: USB (ver. 1.1) standard

Internal memory devices: 3.5 MB internal memory

Data backup functions: Setup conditions: EEPROM; Clock: lithium secondary battery

Operating Environment: 0 to 40°C, 30 to 80% RH

Withstand voltage: 1 minute at 350 Vp-p (between each input channel and main unit chassis)

Power supply: AC adapter: 100 to 240 VAC, 50/60 Hz
DC input: 8.5 to 24 VDC
Battery pack (option): 7.4 VDC (2200 mAh)

Power Consumption: AC Power consumption (when AC adapter is used)

Condition	Normal Consumption	Consumption during battery recharge
LCD on	12 VA	28 VA
Screensaver on	11 VA	27 VA

DC Power consumption

DC Voltage	Condition	Normal Consumption	Consumption during battery recharge
+24V	LCD on	0.18 VA	0.6 VA
+24V	Screensaver on	0.15 VA	0.57 VA
+12V	LCD on	0.30 VA	Can't Recharge
+12V	Screensaver on	0.25 VA	Can't Recharge
+8.5V	LCD on	0.42 VA	Can't Recharge
+8.5V	Screensaver on	0.35 VA	Can't Recharge

External Dimensions: 194 × 122 × 41 mm

Weight: 480g (excluding AC adapter and battery)

Other: Beeper (key, etc.)

PC Interface

Interface types: USB (ver. 1.1)

Functions: Data transfer to PC (real time, memory)
PC control of the GL200A

Real time data transfer speed: 0.1 s (10ch) maximum

Overall Functional Specifications

Display Screen: Waveform display: Waveform screen + digital screen, waveform screen
Digital display: Waveform screen + digital screen, digital screen + calculation display screen (can be key-toggled)

Sampling interval*: 10, 20, 50, 100, 125, 200, 250, 500 ms; 1, 2, 5, 10, 20, 30 s; 1, 2, 5, 10, 20, 30 min; 1 h

Waveform expansion/contraction
Time axis: 1, 2, 5, 10, 20, 30 sec/Div
1, 2, 5, 10, 20, 30 min/Div
1, 2, 5, 10, 12, 24 h/Div
Voltage axis: variable span

Scaling function: 4 points can be set for each channel.

Review function: Data replay during data capture (dual-screen display)

Data save functions: Capture to internal memory, capture to USB memory, setup data can be saved, copy of data screen saved.

Statistical Calculation: Types of operation: Average value, peak value, max/min value, RMS. 2 operations can be set simultaneously. Method: real time operation (when the digital screen + calculation display screen has been specified, the calculation results are displayed)

Search functions: Function: Search the captured data for the required number of points
Search type: Channel pulse, logic, alarm search

Annotation input function: Function: A comment can be input for each channel.
Inputtable characters: Alpha numerics
Number of characters: 11 (8 displayed)

*50 ms and below can be selected according to input settings and number of measured channels.

Analog Channel Specifications

Number of inputs: 10

Input method: Photo MOS relay scanning system; all channel isolated

Scan speed 0.1s/10 ch maximum

Measurement Ranges

Voltage: 20, 50, 100, 500 mV, 1, 2, 5, 10, 20, 50 V, 1-5 VFS

Temperature: Thermocouples: K, J, E, T, R, S, B, N, W

Humidity: 0 to 100% (Voltage 0V to 1V scaling conversion)

Measurement accuracy*

Voltage: 0.1% of Full Scale

Temperature:

TC	Measurement Temperature Range (°C)	Measurement Accuracy (°C)
R/S	0 ≤ Ts ≤ 100	±5.2
	100 < Ts ≤ 300	±3.0
	R: 300 < Ts ≤ 1600 S: 300 < Ts ≤ 1760 reference contact compensation accuracy	±(0.05% of rdg +2.0) ±(0.05% of rdg +2.0) ±0.5
B	400 ≤ Ts ≤ 600	±3.5
	600 ≤ Ts ≤ 1820 reference contact compensation accuracy	±(0.05% of rdg +2.0) ±0.5
K	-200 ≤ Ts ≤ -100	±(0.05% of rdg +2.0)
	-100 < Ts ≤ 1370 reference contact compensation accuracy	±(0.05% of rdg +2.0) ±0.5
E	-200 ≤ Ts ≤ -100	±(0.05% of rdg +2.0)
	-100 < Ts ≤ 800 reference contact compensation accuracy	±(0.05% of rdg +1.0) ±0.5
T	-200 ≤ Ts ≤ -100	±(0.1% of rdg +1.5)
	-100 < Ts ≤ 400 reference contact compensation accuracy	±(0.1% of rdg +0.5) ±0.5
J	-200 ≤ Ts ≤ -100	±2.7
	-100 < Ts ≤ 100	±1.7
	100 < Ts ≤ 1100 reference contact compensation accuracy	±(0.05% of rdg +1.0) ±0.5
N	0 ≤ Ts ≤ 1300 reference contact compensation accuracy	±(0.1% of rdg +1.0) ±0.5
W	0 ≤ Ts ≤ 2315 reference contact compensation accuracy	±(0.1% of rdg +1.5) ±0.5

Reference contact compensation accuracy: Internal/External switching

A/D converter: 14 bits

Temperature coefficient: Gain: 0.01% of F.S./ °C

Input resistance: 1 MΩ ±5%

Allowable signal source resistance: Within 300Ω

Maximum permissible input voltage: Between +/- terminals: 60 Vp-p
Between input terminals and casing: 60 Vp-p

Withstand voltage: Between each input channel and main unit chassis, and also between each CHs: 1 minute at 350 Vp-p

Insulation resistance: At least 50 MΩ (at 500 VDC)

Common mode rejection ratio: At least 90 dB (50.60 Hz; signal source 300 Ω or less)

Noise: At least 48 dB (with +/- terminals shorted)

Filter: Off, 2, 5, 10, 20, 40
Filter operation is on a moving average basis. The average value of the set sampling count is used.

* 23°C ±3°C when 30 minutes have elapsed after the power was switched on (filter On (10), 1 s sampling).

Integral TFT LCD Display

Display: 3.5-inch TFT color LCD (320 × 240 dots)

Displayed languages: English, French, Japanese

Backlight life: 10000 hr (25 ±5°C with continuous lighting)

Backlight: Screensaver function (10, 30 sec., 1, 2, 5, 10, 30, 60 min.)

GL200A Specifications (continued)

Internal Memory Devices

Memory capacity: Internal memory: 3.5MB
USB memory: Depends on type of memory used.

Memory contents: Setup conditions, measured data, screen copy

Trigger Function Specifications

Repeat trigger: Off, On

Trigger types: Start: Data capture starts when a trigger is generated.
Stop: Data capture stops when a trigger is generated.

Trigger conditions: Start: Off, Level, Date
Stop: Off, Level, Date, Time

Alarm judgment modes: Analog, Logic, Pulse
Analog: H, L, Window In, Window Out
Logic: H, L
Pulse: H, L

Discrete I/O Specifications

Input/Output types: Trigger input (1 ch), Logic input (1 ch), Pulse input (1 ch), Alarm output (1 ch)

Input specifications: Maximum input voltage: +24V
Input threshold voltage: Approx. +2.5V
Hysteresis: Approx. 0.5V (+2.5V to +3V)

Alarm output specifications: Output format: Open collector output (100 k Ω pull-up resistance)
Output conditions: Level judgment, window judgment, logic pattern judgment, pulse judgment

Pulse input

Revolutions mode (engines, etc): Function: Counts the number of pulses per second; enables them to be converted to rpms.
Spans: 50, 500, 5000, 50k, 500k, 5M, 50M, 500M PRM/F.S.

Counts mode (electric meters, etc.): Function: Displays a count of the number of pulses for each sampling interval from the start of measurement.
Spans: 50, 500, 5000, 50k, 500k, 5M, 50M, 500M C/F.S.

Inst. mode: Function: Counts the number of pulses for each sampling interval. Resets the count value after each sampling interval.
Spans: 50, 500, 5000, 50k, 500k, 5M, 50M, 500M C/F.S.

Maximum number of pulse inputs: Counts, Inst. modes: 50k/sampling interval
Revolutions: 50k/s

Ordering Guide

Description	Order No.	Description	Order No.
GL200A Compact, lightweight, multi-channel data logger with 10 analog measurement channels, 20mV to 50V Full Scale measurement range, and 3.5 MB internal flash memory.	GL200A	Battery pack 7.2V/2200mAh lithium battery pack.	B-517
		DC Power Cable 2-meter DC power cable, bare tips.	B-514
		Humidity Sensor 3-meter with dedicated power connector.	B-530
		Carrying Case Designed specifically for the GL200A	B-536



DATAQ Instruments, Inc.
241 Springside Drive
Akron, Ohio 44333
Phone: 330-668-1444
Fax: 330-666-5434

Data Acquisition Product Links

(click on text to jump to page)

[Data Acquisition](#) | [Data Logger](#) | [Chart Recorder](#) | [Thermocouple](#) | [Oscilloscope](#)