

**METAL
WORKS™**

NEW FOR 2012- METAL
WORKS EXCALIBUR,
SEE PG. 18

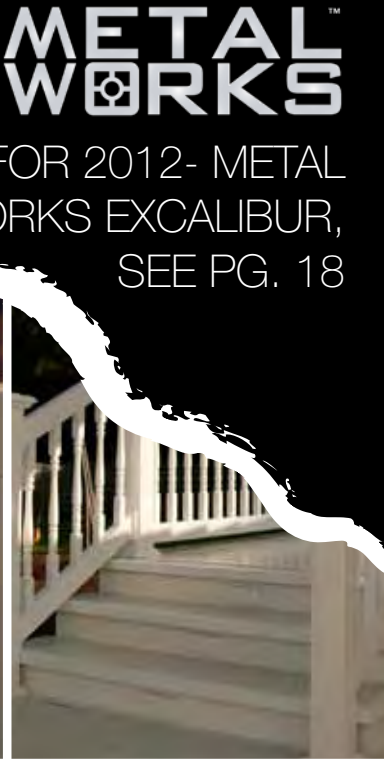
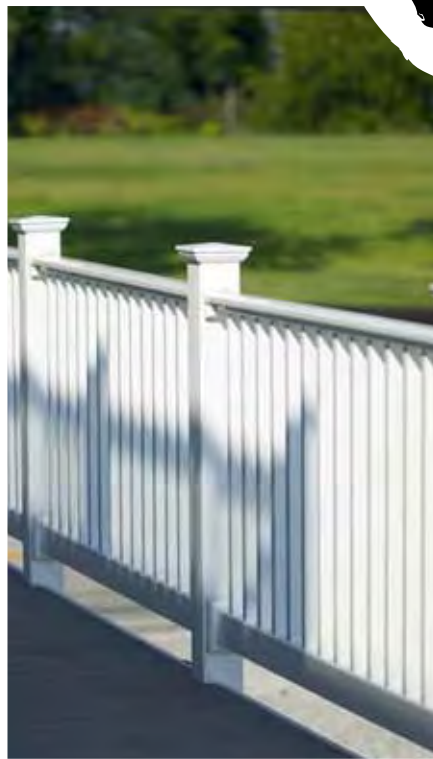

rdi®

For home, for life.®

www.rdirail.com



YOU'VE GOT CHOICES, SO WHY US?

#1 BRAND

RDI's Endurance® brand is the longest standing, most recognized brand in the railing industry.

WE ARE A RAILING COMPANY

RDI is a RAILING company, and that's all we do. We're not a decking, fencing, siding, or roofing company that one day decided to sell railing. Unlike those other products, railing is a life-safety product and we take protecting you and your family very seriously.

TOP IN CUSTOMER SERVICE

We exist because of you, our Customer, and for that reason we have always made Customer Service our top priority. We are proud to say that our Customers tell us that we are ranked at the top in Customer Service before, during, and after the sale. Don't believe it? Just call us and you will find out why.

OLDEST VINYL RAILING COMPANY IN THE USA

Most of our products carry a lifetime warranty. We pioneered the concept of vinyl railing over 20 years ago, and we are still here standing behind our products. As far as we know, no one else can say that! How can you trust that the alternative choices will be here later?

LEADING INNOVATOR

We are the leading innovator in the porch and railing product category with 5 patents and 6 trademarks. Why buy from a re-seller of OUR ideas when you can buy directly from us?

TOP DISTRIBUTION NETWORK

To be the best in Customer Service you need the best in Distribution Partners. We pride ourselves on our dedicated family of Distributors. An extension of RDI, our Distributors will stand behind your purchase and provide you the support you need too.

WE MADE IT SIMPLE

The founders of RDI were carpenters who knew the importance of keeping products "simple stupid". Whether you're a skilled craftsman or a "weekend warrior", our products are simple, and our top-quality instructions complete with illustrations come in every box. If you still need some extra help, pick up the phone and we will gladly walk you through it.

PRODUCT GUIDE CONTENTS

- **Endurance Original Rail Systems:** Pg. 3-5
- **Endurance Deck Rail Systems:** Pg. 6-9
- **Endurance Porch Rail Systems:** Pg. 10-13
- **Titan Pro Rail Systems:** Pg. 14-17
- **Metal Works Excalibur Systems:** Pg. 18-21
- **Crossover Products:** Pg. 22-23
- **Porch and Newel Systems:** Pg. 24-25
- **Endurance Hand Rail Systems:** Pg. 26-27
- **Ordering Guide:** Pg. 28-58
- **Your Rail, Your Way Program:** Pg. 59



Shown: Endurance Original Rail with Square balusters & New England Post Caps



Shown: Endurance Original Rail with Turned balusters & Round Column Brackets

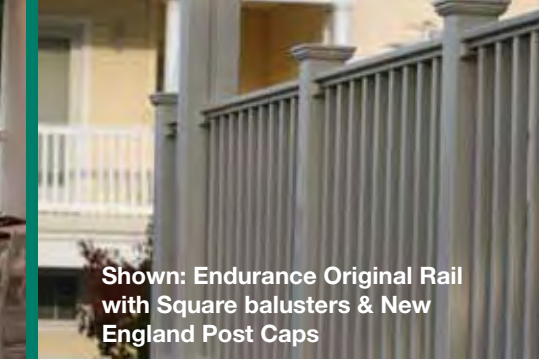

Shown: Endurance Original Rail with Square balusters & New England Post Caps

Endurance®

ORIGINAL RAIL™



is the cornerstone of the Endurance product line. A complete railing system with options including square, turned, round metal, belly, glass balusters, and glass panel. All may be coupled with a variety of accessory bracket kits that allow installation to any surface at any angle. Simple form and dependable function unite these rail designs to maintain safety without sacrificing the elegant presentation of your home or commercial space.

No detail is too small, and we've considered them all, down to the tamper-proof screw head covers. The vinyl-clad aluminum stiffeners provide strength and durability. The unique locking pin design ensures secure, invisible attachment of the aluminum back to the building structure.



The Endurance Original Rail System exceeds U.S. building code requirements and has been independently tested by PFS laboratories, a third-party, ICC-ES certified testing and inspection agency. Visit www.icc-es.org to view ESR-1849 Acceptance Report or to obtain the most current testing certifications.

Always consult your local Building Code Department for applicable regulations and product acceptance.

For additional information on Endurance or other RDI products visit www.rdirail.com or contact our Customer Service Department at (877) 420-7245.

ORIGINAL RAIL IS AVAILABLE IN WHITE, EARTH, AND SAND.





Shown: Endurance Original Rail with Turned balusters, Flat Post Caps & Round Column Brackets



Shown: Endurance Original Rail with Square balusters & New England Post Caps



Shown: Endurance Original Rail with Turned balusters, New England Post Caps, New England Trim Rings & Round Column Brackets



ORIGINAL RAIL FEATURE SPOTLIGHT

BUTTON CAPS

Finish the job by snapping in the screw hole covers and make the fastener heads disappear.

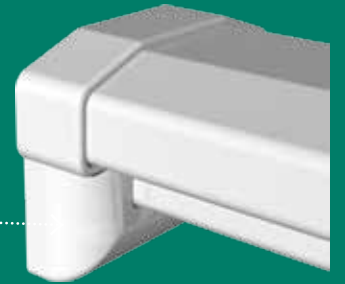

ENGINEERED STRENGTH

Aluminum stiffener fits the vinyl profile perfectly and is specifically engineered to maximize strength.

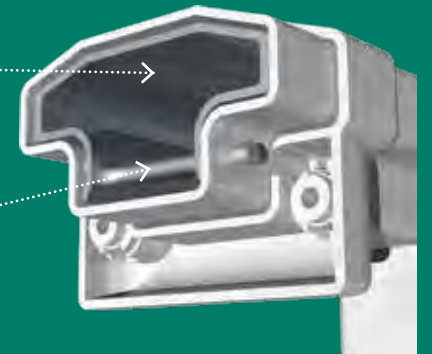

LOCKING PIN

The Locking Pin feature secures the aluminum stiffener directly to the building structure.

ALUMINUM STIFFENER

Unlike products with steel reinforcements that corrode and stain, aluminum is used in the top and bottom rails* and can be cut easily on-site along with the vinyl using a carbide tipped blade to speed installation.

2- PIECE ADJUSTABLE LEVEL RAIL SUPPORT FOOT (EALRS)

The support foot should be added to rail sections longer than 8' to strengthen the installation. The height can easily be adjusted on-site (sold separately).

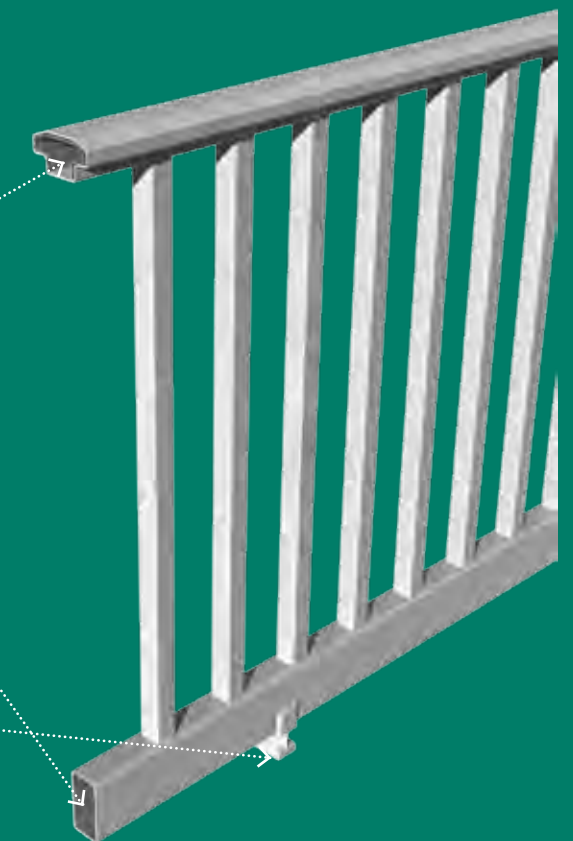

*Aluminum Stiffener is not a component in the bottom rail of the QX Railing system.



Shown: Endurance Deck Rail with Decorative Cap



Shown: Endurance Deck Rail with Square balusters & Kindle Solar Post Cap



Shown: Endurance Deck Rail with Glass balusters & New England Post Caps



Shown: Endurance Deck Rail with Decorative Cap, Turned balusters and Elite Post Cap

Endurance[®] DECK RAIL[™]



is the ultimate combination of superior design and beauty. We've set a new standard in the vinyl railing industry with our innovative wide top cap design—an optional decorative feature that beautifies and serves as an active surface on your deck while barbecuing or relaxing. Made from a durable cellular PVC, the cap was designed to provide a continuous clean line over the intermediate newel posts.

Deck Rail offers the same flexibility in design as Original Rail with baluster options including square, turned, round metal, belly, and glass balusters. Accessory bracket kits provide simple solutions to your unique railing installation, including mounting to round columns or angles ranging from 0 to 45°.



Shown: (Top deck) Endurance Original Rail with Square balusters. (Bottom deck) Endurance Deck Rail with Decorative Cap, Square balusters, Elite Post Caps and Elite Trim Rings



The Endurance Deck Rail System exceeds U.S. building code requirements and has been independently tested by PFS laboratories, a third-party, ICC-ES certified testing and inspection agency. Visit www.rdirail.com to view testing data online or print a report.

Always consult your local Building Code Department for applicable regulations and product acceptance.

For additional information on Endurance or other RDI products visit www.rdirail.com or contact our Customer Service Department at (877) 420-7245.

DECK RAIL IS AVAILABLE IN WHITE ONLY.



FEATURE SPOTLIGHT



2-PIECE LEVEL BRACKET

The innovative 2-piece level bracket is designed for installations with or with-out the Decorative Cap. The locking screw secures the aluminum channel into the brackets and disappears under the top bracket cap. Molded locking screw plugs cover the stainless fasteners.

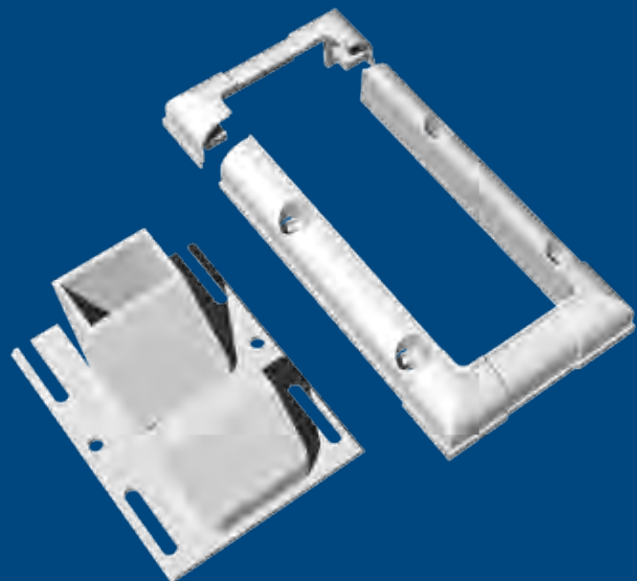

3-PIECE STAIR BRACKET

The 3-piece stair bracket accommodates any stair angle and the 2-piece face plate adjusts and installs easily for a secure attachment and clean appearance.

DECORATIVE CAP

The extra wide design of our Decorative Cap provides added utility and function. It will also allow "over the post" or "post to post" installation for a customized look.

MOLDED END CAP

The molded End Cap finishes the installation and provides the look of a custom railing.



ALUMINUM REINFORCEMENT

The aluminum channel in the top & bottom rails add extra strength to the installation.* The aluminum channels cut easily on-site and won't rust and stain your deck or railing the way steel inserts will.

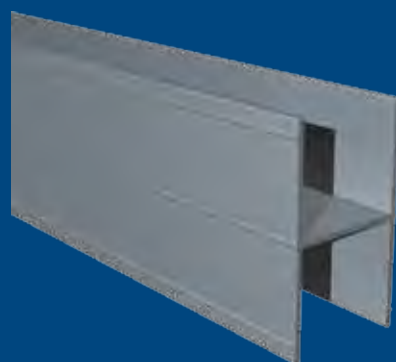

*Note: 8' railing kit channel pictured above, design will vary with kit length.

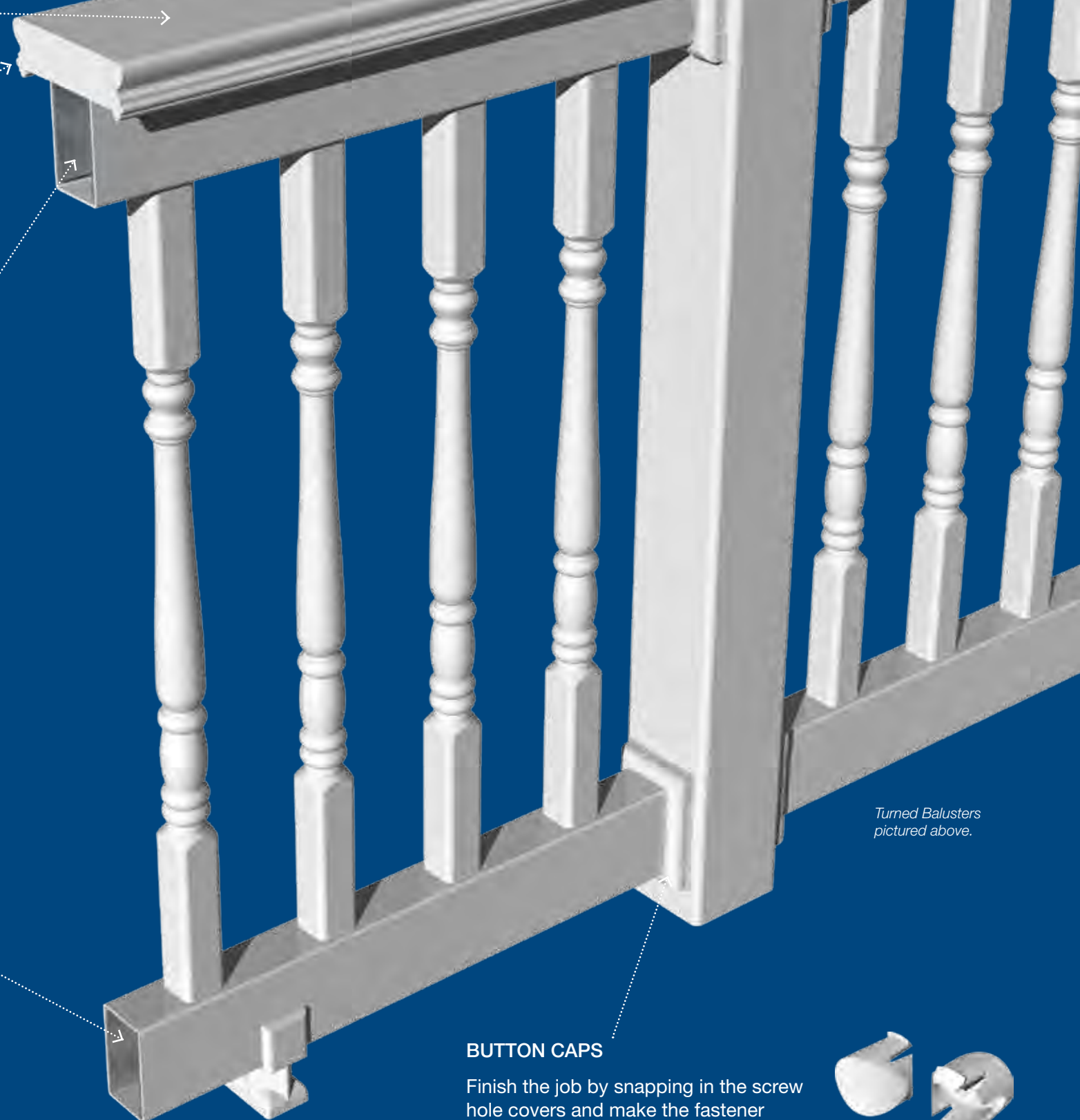

Turned Balusters pictured above.

BUTTON CAPS

Finish the job by snapping in the screw hole covers and make the fastener heads disappear.





Shown: Endurance Porch Rail with Square balusters & New England Post Caps & New England Trim Rings



Shown: Endurance Porch Rail with Painted Textured Top Cap, Square balusters & New England Post Cap



Shown: Endurance Porch Rail with Square balusters & New England Post Cap



Endurance®



PORCH RAIL™

Thinking about adding a new look to your porch or deck but can't seem to find exactly what you're looking for? If you're looking for something low-maintenance, easy to install, and at the same time reflects your personal style, then have we got the product for you...

Porch Rail from the Endurance family of products offers safe, quality railings that you and your family can depend on while allowing you to easily design a beautiful, unique look that will be the envy of the neighborhood. Porch Rail has it all; a smooth, textured (for painting), or custom wood top cover, multiple baluster options, hidden brackets and fasteners, and easy wiring capabilities for lighting or speakers and more!

Not only do you have piece of mind with a railing from a name you know and trust but now you can make your outdoor living space fun! Add a splash of color to your porch or deck, light up your nights with some low voltage lighting, or easily add wire for your own personal sound system so you can listen to your favorite tunes while you relax after a long day. With Porch Rail, if you can imagine it, you can do it!



The Endurance Porch Rail System exceeds U.S. building code requirements and has been independently tested by PFS laboratories, a third-party, ICC-ES certified testing and inspection agency. Visit www.rdirail.com to view testing data online or print a report.

Always consult your local Building Code Department for applicable regulations and product acceptance.

For additional information on Endurance or other RDI products visit www.rdirail.com or contact our Customer Service Department at (877) 420-7245.

PORCH RAIL IS AVAILABLE IN WHITE ONLY.



Shown: Endurance Porch Rail with Custom Wood Top Cap, Square balusters & New England Post Caps

PORCH RAIL FEATURE SPOTLIGHT

TOP COVER

Choose from 3 Top Cover styles:
Smooth - smooth cover surface provides a sleek, classic look.

Textured - unfinished cover engineered to be painted for a look that compliments any design.

Wood - the Top Cover (inset) can be custom made in most wood species of your choice or any wood or composite deck board can be milled to fit the aluminum structure. Custom Wood Top Covers must be ordered separately from railing kits.



ALUMINUM STIFFENER

Top & bottom aluminum stiffeners provide channels to accommodate various baluster styles. The top center channel is designed to accept wiring for low-voltage lighting or speakers.

ALUMINUM BRACKETS

Heavy-cast brackets interlock securely with the aluminum beams. All brackets and fasteners are hidden for a clean finish.

BEAM COVERS

Patented Beam covers are designed to "snap-fit" over the aluminum beams for a simple installation.

BALUSTERS

Balusters are available in square, turned, round metal, glass and belly designs. No additional fasteners are required, further simplifying installation.

Porch Rail is covered by US patent number 7,744,065B2.



Shown: Endurance Porch Rail with Smooth Top Cover and Square balusters



Shown: Endurance Porch Rail with Smooth Top Cover, Square balusters, New England Post Caps and New England Trim Rings



Shown: Endurance Porch Rail with Wood Top Cover, Square balusters & Kindle Solar Post Caps

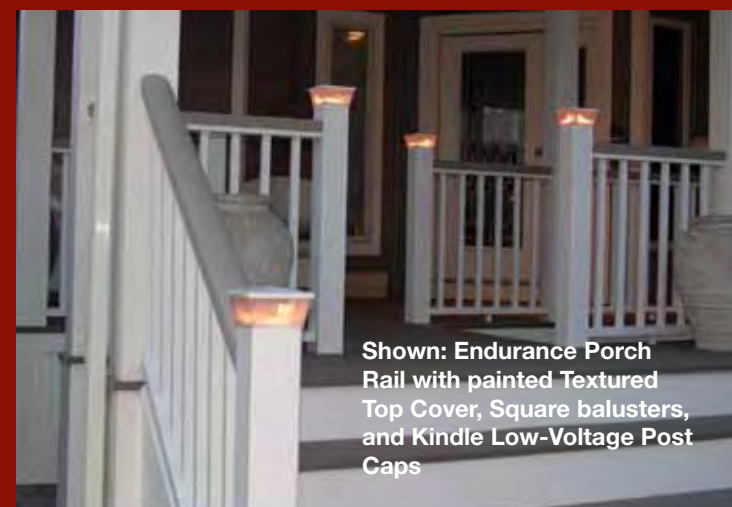

Shown: Endurance Porch Rail with painted Textured Top Cover, Square balusters, and Kindle Low-Voltage Post Caps



Shown: Endurance Porch Rail with Wood Top Cover, Round Metal balusters, New England Post Caps and New England Trim Rings

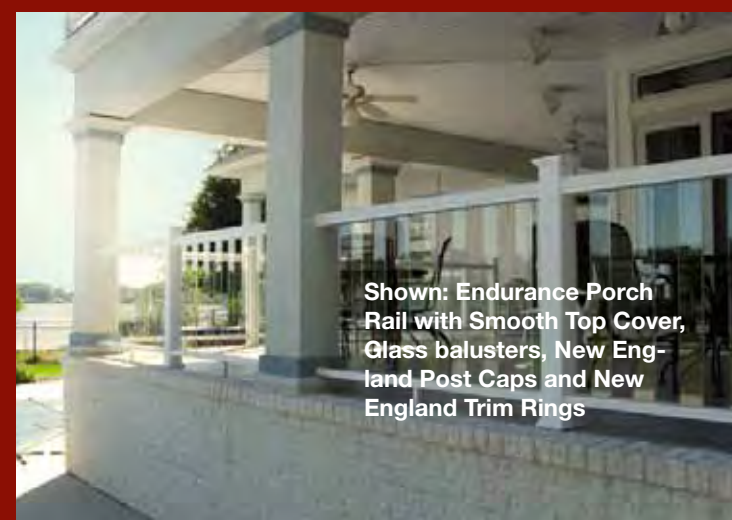

Shown: Endurance Porch Rail with Smooth Top Cover, Glass balusters, New England Post Caps and New England Trim Rings



Shown: Titan Pro Rail, Titan Mid & Corner Post with Decorative Post Caps



Shown: Titan Pro Rail, Titan Corner Post with Decorative Post Cap



Shown: Titan Pro Rail, Titan Corner Post with Decorative Post Cap

TITAN
PRO RAIL



TITAN PRO[®] RAIL

Titan Pro and Titan Pro XL were created with the installer in mind. A Titan rail section assembles in minutes and is ideal for residential and commercial applications. Metal-to-metal connections add to the sound engineering that enables easy and safe installations. Titan is manufactured using the highest quality materials to meet your performance and building requirements.

Titan's pre-assembled, galvanized steel posts eliminate the time consuming task of installing brackets on the job. We've already done your work for you. Corner, end, and mid posts are supplied with heavy duty cast aluminum level rail brackets attached to vinyl-sleeved steel structural posts. Blank posts (no pre-attached brackets) are also offered for stair and other custom applications. Flexible vinyl bracket covers are supplied with the posts and bracket kits, and are snapped on when the installation is complete, concealing all mounting hardware. Titan gives you the strength and durability of a metal system without the maintenance.

TITAN PRO RAIL IS AVAILABLE IN WHITE ONLY



The Titan Pro Rail System exceeds U.S. building code requirements and has been independently tested by a third-party, ICC-ES certified testing and inspection agency. Visit www.rdirail.com to view testing data online or print a report.

Always consult your local Building Code Department for applicable regulations and product acceptance.

For additional information on Titan Pro Rail or other RDI products visit www.rdirail.com or contact our Customer Service Department at (877) 420-7245.



Shown: Titan Pro Rail, Titan Corner Post with Decorative Post Cap



Shown: Titan Pro Rail with Titan Posts, Decorative Post Cap and 4" Turned Porch Post



Shown: Titan Pro Rail, Titan Corner Post with Decorative Post Cap



Shown: Titan Pro Rail, Titan Posts with Decorative Post Caps and 4" Turned Porch Post



Shown: Titan Pro Rail, Titan Mid Post with Decorative Post Cap and Flat Post Wraps



Shown: Titan Pro Rail, Titan Blank Post with Decorative Post Cap

TITAN PRO RAIL FEATURE SPOTLIGHT

PRE-ASSEMBLED POST

Extremely strong, full height, heavy duty 3" x 3" square galvanized interior post extends above the top brackets, providing a metal to metal connection between the brackets and posts.

Posts have a 1/4" x 5" x 5" square flange plate welded to the upright and are hot dip galvanized.

Flange posts can be mounted to almost any surface.

VINYL POST SLEEVES

Low-maintenance vinyl sleeves are included with the posts.

PRE-INSTALLED BRACKETS

Pre-attached brackets save valuable installation time and ensure consistent code-compliant bottom spacing and finished rail height.

TOP RAIL PROFILE

The Top Rail profile is designed to meet the International Residential Code for stair hand railing; no secondary handrail is needed for residential applications.

BALUSTER OPTIONS

Crimped balusters allow you to pre-assemble railing sections and move them to the installation area in one unit; simply drop the pre-assembled section into the pre-installed brackets.

Choose from the narrow, 1" baluster design for heightened visibility in Titan Pro, or for a more traditional, substantial appearance, Titan Pro XL offers a larger, 1 1/4" baluster.

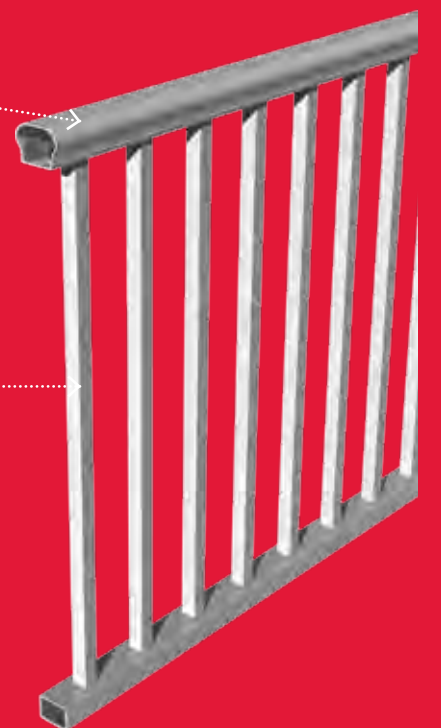



Shown: Metal Works Excalibur with Custom Wood Top & Neptune Post Cap



Shown: Metal Works Excalibur with New England Post Cap and Elite Trim Rings



Shown: Metal Works Excalibur Rail and Posts

METAL WORKS



EXCALIBUR®

Sexy. Sophisticated. A new twist on a time-proven idea. We've taken elements you've loved from our Endurance and Titan Pro railing systems and created Excalibur, the new railing line from the RDI Metal Works family. Endurance-like hidden attachments, Titan-like easy installation, economical, and a sleek satin finish, are all combined together to create our first fully metal system. Sure, metal has been around for a while, but you've never seen it quite like this.

Excalibur's pre-welded components provide strength, while its' triple-coat finishing process ensures durability. The pre-mounted brackets allow for quick installation. The satin, low-gloss finish hides marring, fingerprints, smudges and other dirt that can otherwise make a gorgeous installation look like it is in desperate need of a spit-shine.

Excalibur doesn't have to stop at being a suit of armor for your deck; you can add a feeling of warmth to the toughness of steel. Create a touch of elegance with our custom wood top option. Mix it up by combining white, earth, or sand post and accessory options from the Endurance and Titan systems.

EXCALIBUR RAIL IS AVAILABLE IN BLACK ONLY.



Shown: Metal Works Excalibur with Custom Wood Top & Neptune Post Caps and New England Trim Rings



Shown: Metal Works Excalibur Rail and Posts



Shown: Metal Works Excalibur with Neptune Post Caps and Elite Trim Rings



Shown: Metal Works Excalibur with Custom Wood Top, Neptune Post Caps and Elite Trim Rings



Shown: Metal Works Excalibur Rail and Posts



Shown: Metal Works Excalibur with Custom Wood Top and Neptune Post Caps

EXCALIBUR FEATURE SPOTLIGHT

SECURITY AND STRENGTH

Beneath Excalibur's sleek exterior lies the strength and security of steel.

TRIPLE-COAT SATIN FINISH

Components are fully welded prior to immersion in a zinc phosphate bath. They are then galvanized prior to an electrostatically applied DuPont* powder coat finish which is baked for maximum durability. The low gloss satin finish helps hide marring, fingerprints and dirt.

CUSTOM WOOD TOP

Our Custom Wood Top (inset) can be custom made in most wood species of your choice or any wood or composite deck board can be milled to fit the steel top rail.



FULLY ASSEMBLED, FACTORY-WELDED RAIL PANELS

Assembled and welded rail panels save valuable installation time. The process is as easy as: measure, cut, install.

BRACKETED POSTS

Pre-attached level brackets means no measuring, pre-drilling, or attaching brackets to the posts and ensures consistent code-compliant bottom spacing and finished rail height.

HINGED STAIR PANELS

Stair panels are hinged to allow easy installation at virtually any angle.

ALL-IN-ONE PIVOTING BRACKETS

Our unique all-in-one pivoting brackets allow attachment at virtually any stair pitch or level angle without difficult mitre cuts.

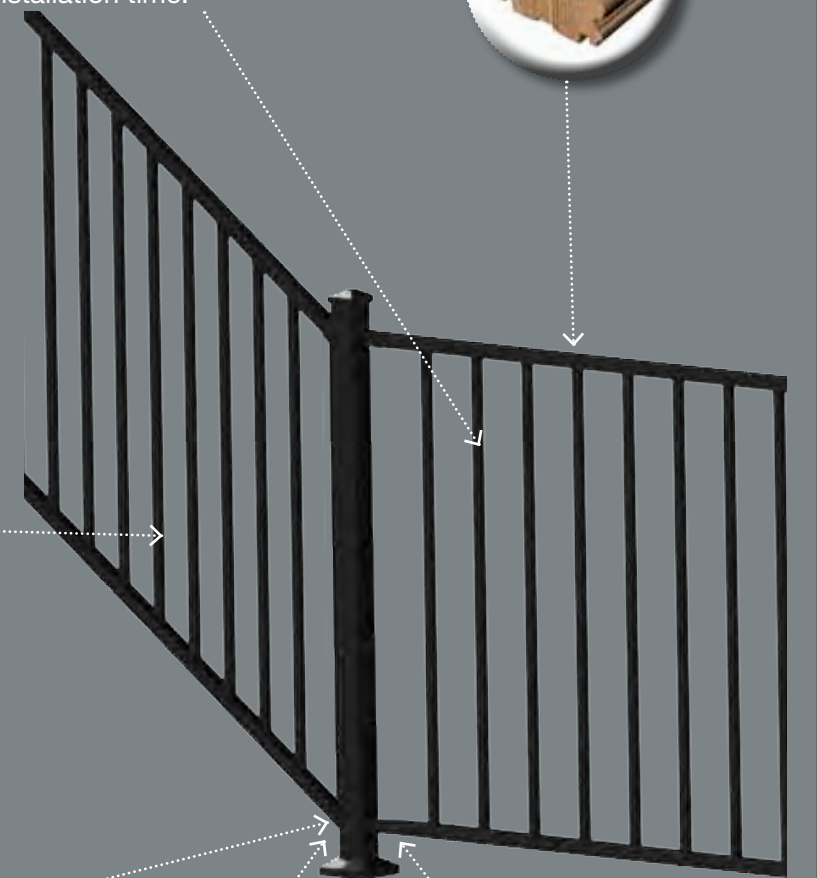
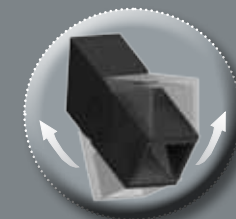

HIDDEN MOUNTING HARDWARE

All attachment hardware is completely concealed from view.

*DuPont™ is a registered trademark of E. I. du Pont de Nemours and Company or its affiliates.



Shown: Endurance Deck Rail with Decorative Cap & Elite Post Cap



Shown: Endurance Elite Trim Ring



Shown: Endurance Original Rail with New England Post Cap



Shown: Endurance Original Rail with New England Post Cap and New England Trim Ring



Shown: Endurance Flat Post Wrap with Elite 4-Piece Adjustable Trim Ring



Shown: Endurance Deck Rail with Kindle Solar Post Cap



Shown: Endurance Deck Rail with graspable Hand Rail and Elite Post Cap

Endurance® CROSSOVER PRODUCT™



includes Post Wraps, Post Sleeves, Gates, Post Caps and Trim Rings, all of which are compatible with Endurance and Titan Pro Rail* systems and are made from low-maintenance vinyl.

Installing a post wrap requires only two steps: cutting to fit, and snapping the pieces into place. The post sleeve slides over an existing wood post or the Endurance structural post. The decorative post caps and trim rings provide a finished look to your installation. Our complete line of gate kits will compliment any project.

*If you are using Titan Pro Rail pre-assembled posts, the caps for Titan can be found in the Titan Pro section (pg. 32).

CROSSOVER PRODUCTS ARE AVAILABLE IN WHITE, EARTH, AND SAND.

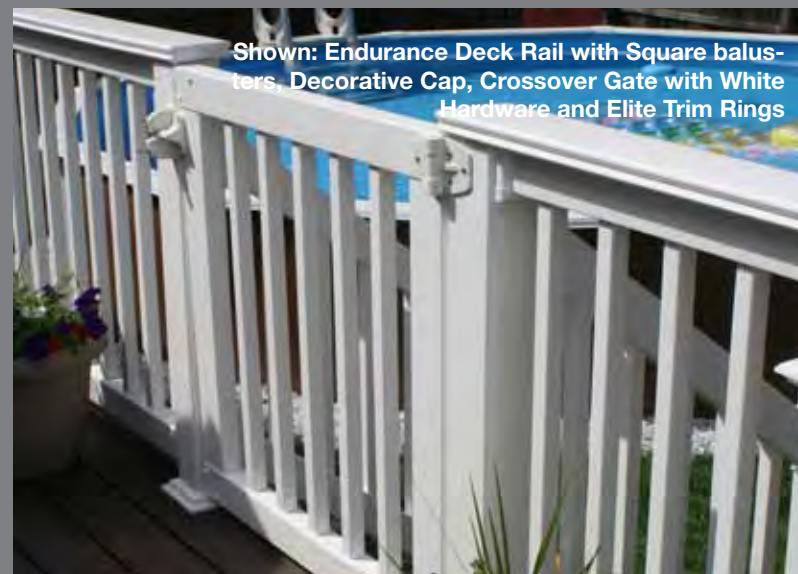

Shown: Endurance Deck Rail with Square balusters, Decorative Cap, Crossover Gate with White Hardware and Elite Trim Rings



Shown: Endurance Turned Porch Posts in Sand, Earth, and White



Shown: Endurance Turned Porch & Newel Posts with Elite Post Caps & Trim Rings



Shown: Endurance Turned Newel Post with Elite Post Cap



Shown: Endurance Deck Rail with Decorative Cap, Turned balusters, 45° Level Angle Brackets, Turned Porch Posts, Turned Newel Sleeves, Elite Trim Rings, Elite Adjustable Trim Rings & Elite Post Caps

Endurance® PORCH & NEWEL POST™



designs come in an elegant turned, painted wood post style and a traditional 4 inch square style, without the maintenance. Underneath the classic designs of the porch post is a load-bearing aluminum column with a capacity of 2,500 lbs. (4"x4"), 5,000 lbs. (5"x5"), or 8,500 lbs. (5"x5").

Our base kits are available in two performance options: a Standard Base Kit and a Wind Uplift Base Kit. Both kits are available in 4" and 5" sizes and include everything necessary in one kit. The Wind Uplift Base Kit utilizes a one-of-a-kind Hurricane Piston Lock that prevents wind uplift up to 2,800 lbs. as well as eliminates roof jacking during installation.

We offer an Endurance Structural Post option for virtually any installation, including flush mount, thru-deck, fascia, or masonry core mount applications. These posts are hot-dipped, galvanized schedule 40 posts that provide structure, while the innovative vinyl extrusion centers and secures the vinyl sleeve or newel.

Turned newel post sleeves are thermoformed from low-maintenance PVC and are compatible with all Endurance steel structural posts.

PORCH & NEWEL POSTS ARE AVAILABLE IN WHITE, EARTH, AND SAND.





Shown: Endurance Original Rail with Square balusters, Endurance Hand Rail & Flat Post Caps



Shown: Endurance Original Rail with Endurance Hand Rail



Shown: Endurance Original Rail with Endurance Hand Rail

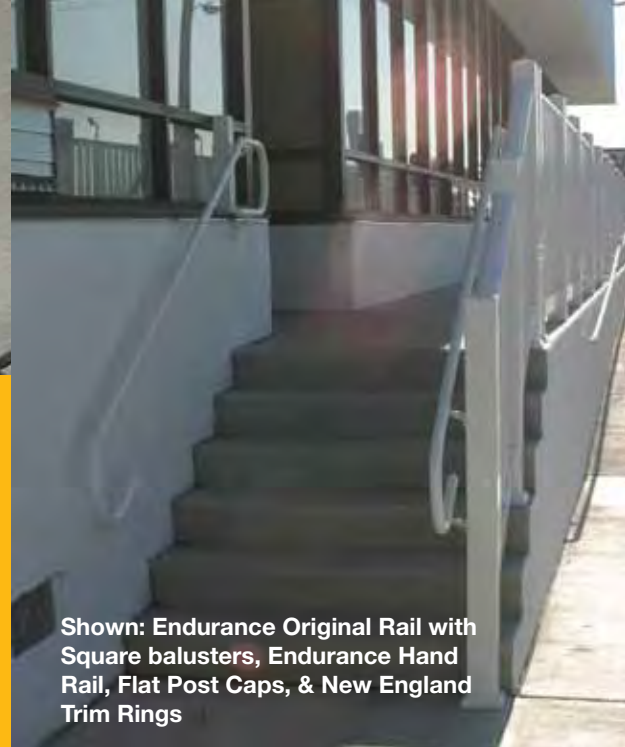

Shown: Endurance Original Rail with Square balusters, Endurance Hand Rail, Flat Post Caps, & New England Trim Rings



Shown: Endurance Hand Rail

Endurance[®] HAND RAIL[™]



Endurance Hand Rail is an ADA compliant graspable hand rail that provides added safety and security to any stair or ramp. The key to its success is its simplicity; we've made the daunting task of installation easy with our step-by-step illustrated instructions and selection of versatile components. Whether it's a simple 3-step front porch stair or a 10-story stair tower, you can do it all - you just need some simple hand tools.

Endurance vinyl clad aluminum Hand Rail features complete metal-to-metal connections for maximum strength. Our cast aluminum adjustable internal joiner ensures a strong joint every time in any direction, and will accommodate angles up to 90 degrees. For a clean, polished look, our engineers have designed our Endurance Hand Rail system to include hidden fasteners that add a custom fabricated appearance to the finished installation. Who says you can't have it all? RDI says you can!

HAND RAIL IS AVAILABLE IN WHITE AND BLACK.



The Endurance Hand Rail System exceeds U.S. building code requirements and has been independently tested by PFS laboratories, a third-party, ICC-ES certified testing and inspection agency. Visit www.rdirail.com to view testing data online or print a report.

Always consult your local Building Code Department for applicable regulations and product acceptance.

For additional information on Endurance or other RDI products visit www.rdirail.com or contact our Customer Service Department at (877) 420-7245.



Shown: Endurance Original Rail with Square balusters, Endurance Hand Rail & Flat Post Caps