

Fixtures, Sinks and Hand Wash Stations

Antimicrobial copper surfaces begin killing pathogens on contact and keep on killing 24/7 to maintain healthy environments!

Produced with CuVerro® Antimicrobial Copper Surfaces



Antimicrobial Defense



Solid defense against harmful microbes. No other solid surface is proven to be more effective in continuously killing bacteria that cause infections. CuVerro® antimicrobial copper is even **better at killing bacteria** than other solid surface products. Copper is the only active, bacteria-killing ingredient in CuVerro alloys. CuVerro's EPA-registered surfaces, begin killing pathogens* on contact, killing 99.9% within two hours, and keep on killing 24/7.

The Mission



Just has been a leading manufacturer of hospital fixtures. We now provide health care products that help kill bacteria* which cause infection, while advancing safety and compliance. Our product made with antimicrobial copper surfaces take the complexity out of the infection control process while helping to ensure maximum effectiveness. Our products contain antimicrobial copper, the world's most effective antimicrobial touch surface material that kills 99.9% of bacteria*.

Just Products



- ★ Healthcare Fixtures
- ★ Scrub Sinks
- ★ Patient Suite Lavatory Sinks
- ★ Nurse's Hand Wash Stations
- ★ Sensor Faucets



JUST...the copper-nickel source for spec series sinks

just manufacturing
justmfg.com



www.justmfg.com/antimicrobial-copper-sinks.aspx



Model		O.D.	I.D.	Depth
Cu-CIF-10		12-1/4"	10" DIA.	5
Cu-CIF-12		14-1/4"	12" DIA.	6
Cu-CIF-14		16-1/4"	14" DIA.	7
Cu-CIF-16		18-1/4"	16" DIA.	8

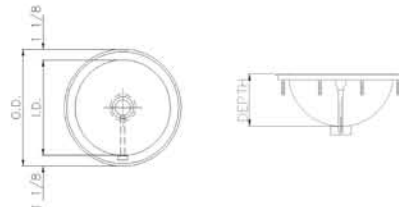

Cu-CIR-10		12-1/4"	10" DIA.	5
Cu-CIR-12		14-1/4"	12" DIA.	6
Cu-CIR-14		16-1/4"	14" DIA.	7
Cu-CIR-16		18-1/4"	16" DIA.	8

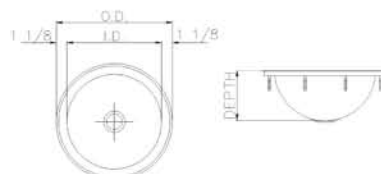

Cu-CLF-10		14-1/2"	10" DIA.	5
Cu-CLF-14		18-1/2"	14" DIA.	7

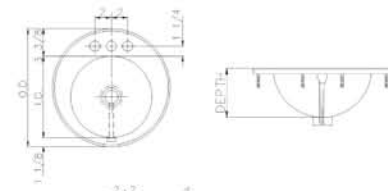

Cu-CLR-10		14-1/2"	10" DIA.	5
Cu-CLR-14		18-1/2"	14" DIA.	7

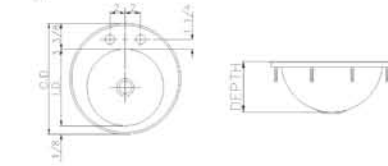

Cu-OLF-1619		16" X 19"	11-3/8" x 15-1/2"	6
-------------	--	-----------	-------------------	---

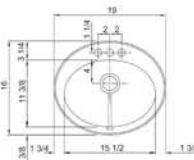

Cu-OLR-1619		16" X 19"	11-3/8" x 15-1/2"	6
-------------	--	-----------	-------------------	---

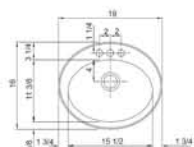

Cu-UCIF-10		12-1/4"	10" DIA.	5
Cu-UCIF-12		14-1/4"	12" DIA.	6
Cu-UCIF-14		16-1/4"	14" DIA.	7
Cu-UCIF-16		18-1/4"	16" DIA.	8

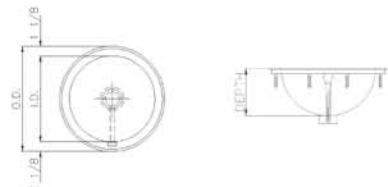

Antimicrobial Copper touch surfaces kill the microbes that cause infections where they lie. CuVerro® Antimicrobial Copper-Nickel Alloy Surfaces kill more than 99.9% of bacteria* within 2 hours, and deliver continuous and ongoing antibacterial action. EPA registered copper alloys are the only solid surface materials that can make this claim as the inhibitive effects of copper alloys decrease as copper content of the alloys decreases.

MRSA Survival Rate on Common Sink Surfaces

At 68°F-95°F & 20%-50% Relative Humidity

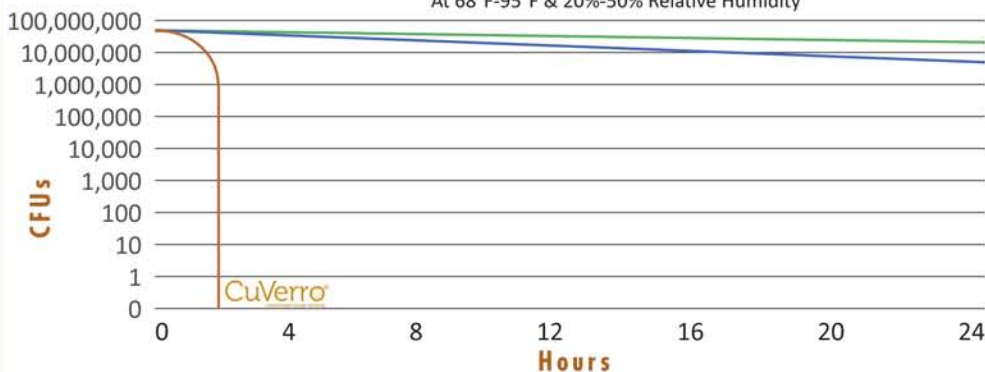

STAINLESS

COATING CONTAINING SILVER

MRSA viability on C11000 copper, stainless steel and silver ion-containing coating on stainless steel. 99.9% of MRSA is killed after 2 hours of exposure on a copper surface (Source: Michels, Noyce, Keevil, 2009.)



ADA COMPLIANT

These units are available ADA Compliant with smooth coat sound deadening. Available in depths shown only. All dimensions shown in inches.

LAVATORY HANDWASH STATIONS (with/without overflow)

Produced with CuVerro® Antimicrobial Copper Surfaces



Model	O.D.	I.D.	Depth
Cu-UCIR-10	12-1/4"	10" DIA.	5
Cu-UCIR-12	14-1/4"	12" DIA.	6
Cu-UCIR-14	16-1/4"	14" DIA.	7
Cu-UCIR-16	18-1/4"	16" DIA.	8

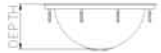
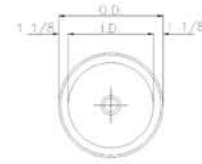

Cu-UOIF-1619	13-3/8" x 17-1/2"	11-3/8" x 15-1/2"	6
Cu-UOIF-1521	15-1/4" x 21-1/2"	12-1/2" x 17-1/2"	6

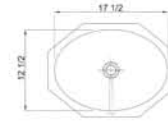

Cu-UOR-1619	13-3/8" x 17-1/2"	11-3/8" x 15-1/2"	6
Cu-UOIR-1521	15-1/4" x 21-1/2"	12-1/2" x 17-1/2"	6

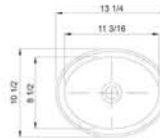

Cu-LLO-1513	15" x 13"	10" DIA.	5
Cu-LLO-1917	19" x 17"	14" DIA.	7

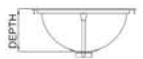
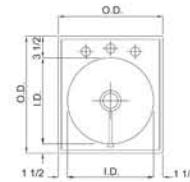

Cu-LOLF-17519	17-1/2" x 19"	11-3/8" x 15-1/2"	6
Cu-LOLF-18521	18-1/2" x 21"	12-1/2" x 17-1/2"	6

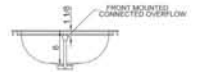
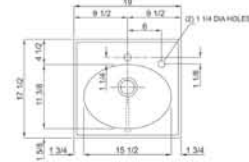

Cu-LOLR-17519	17-1/2" x 19"	11-3/8" x 15-1/2"	6
Cu-LOLR-18521	18-1/2" x 21"	12-1/2" x 17-1/2"	6

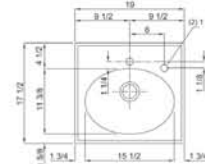

Cu-35929-S*	Wall Hung Lav	10" dia.	5
Cu-35929-14-S*	Wall Hung Lav	14" dia.	7

*Includes: JSL-150 Sensor Faucet and Cu-J-15-FS drain system.

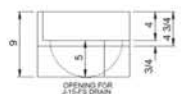
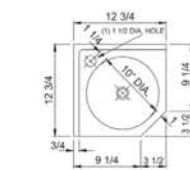

Cu-W1819-S*	Wall-hung lavatory	11-1/2x16"	6
-------------	--------------------	------------	---

*Includes: JSL-100 Sensor Faucet and Cu-J-15-FS drain system.

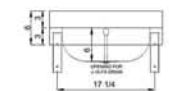
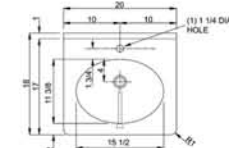

Laboratory testing has shown, that when cleaned regularly, CuVerro® antimicrobial copper surface kills greater than 99.9% of the following bacteria within 2 hours of exposure: MRSA, Vancomycin-Resistant Enterococcus faecalis (VRE), Staphylococcus aureus, Enterobacter aerogenes, Pseudomonas aeruginosa, and E. coli O157:H7.

CuVerro®, copper alloy surfaces have been shown to reduce microbial contamination, but does not necessarily prevent cross-contamination. The use of a copper alloy surface is a supplement to and not a substitute for standard infection control practices; users must follow all current infection control practices, including those practices related to cleaning and disinfection of environmental surfaces.

Copper alloy surfaces are for use only in non-food zone areas.

CuVerro® is a registered trademark of GBC Metals LLC, d/b/a Olin Brass. CuVerro® antimicrobial alloys are registered with the U.S. Environmental Protection Agency as antimicrobial under product registration # 85353-5.



The new Integra Flow system was developed by Just Manufacturing as a response to potential multi-level building flooding liability. These incidents are not isolated to multi-level buildings as any environment can benefit from being safe from the problems caused by overflowing sinks.



Pre-piped for easy hook up

Model	O.D.	I.D.
Cu-J-770-1	24 1/2 x 34	17 1/2 x 30 x 11
Cu-J-770-1-S	24 1/2 x 34	17 1/2 x 30 x 11
Cu-J-770-2	24 1/2 x 64	17 1/2 x 60 x 11
Cu-J-770-2-S	24 1/2 x 64	17 1/2 x 60 x 11
Cu-J-770-3	23 1/2 x 76	17 1/2 x 72 x 11
Cu-J-770-3-S	24 1/2 x 76	17 1/2 x 72 x 11
Cu-J-ADA-770-1	20 x 34	17 1/2 x 30 x 6 1/2
Cu-J-ADA-770-1-S	20 x 34	17 1/2 x 30 x 6 1/2

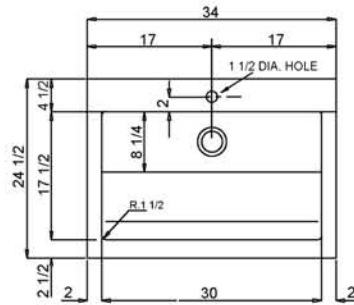

J770-1 TOP VIEW

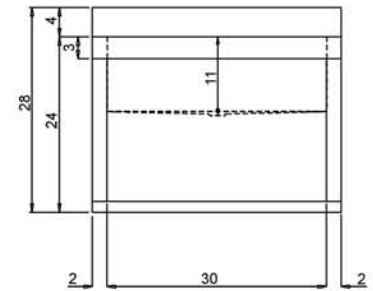

J770-1 FRONT VIEW



OSHPD
Pre-approval
OPA-0684

J770-1-S : Single Station Scrub Sink with Sensor Faucet and Mixing Valve
Includes: One (1) JSGN-6 Sensor faucet, One (1) JTM-47 mixing valve,
One (1) Cu-J-35-FS drain system and One (1) JT-150 P-Trap.

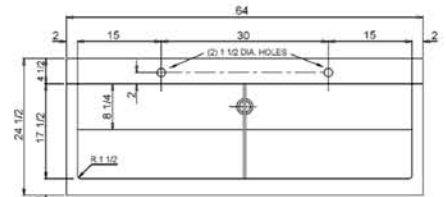

J770-2 TOP VIEW

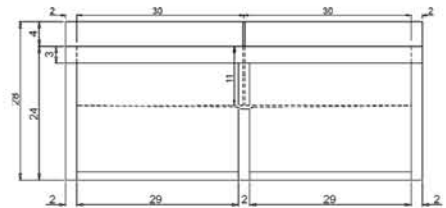

J770-2 FRONT VIEW



OSHPD
Pre-approval
OPA-0811

J770-2-S : Double Station Scrub Sink with Sensor Faucets and Mixing Valve
Includes: Two (2) JSGN-6 Sensor faucet, One (1) JTM-47 mixing valve, One
(1) Cu-J-35-FS drain system, One (1) removable plexi-glass partition, and One
(1) JT-150 P-Trap.

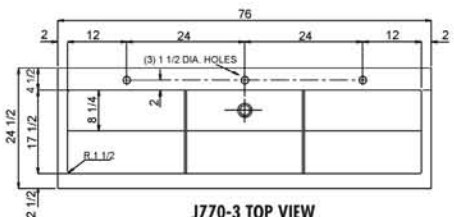

J770-3 TOP VIEW

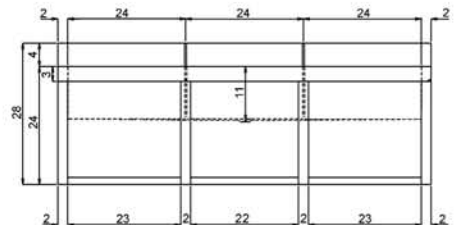

J770-3 FRONT VIEW



OSHPD
Pre-approval
OPA-0812

J770-3-S : Triple Station Scrub Sink with Sensor Faucets and Mixing Valve
Includes: Three (3) JSGN-6 Sensor faucet, One (1) JTM-47 mixing valve,
One (1) JCu-35-FS drain system, Two (2) removable plexi-glass partitions, and
One (1) JT-150 P-Trap.

Antimicrobial Copper touch surfaces kill the microbes that cause infections where they lie.

CuVerro® Antimicrobial Copper-Nickel Alloy Surfaces kill more than 99.9% of bacteria* within 2 hours, and deliver continuous and ongoing antibacterial action. CuVerro® surfaces have been shown in U.S EPA approved testing to kill five specific bacteria*. U.S. EPA registered antimicrobial copper alloys are the only class of solid surfaces that can make this claim as the antimicrobial effects of these alloys decrease as copper content decreases.

Cu-J-15-FS

Copper-nickel drain with flat grid strainer. 1-1/2" O.D. chrome plated tailpiece, 4" long.



Cu-J-35-FS

Copper-nickel drain with flat strainer and 1-1/2" O.D. chrome plated brass tailpiece, 4" long.



TECHNICAL DATA

- 16 gauge type 304 stainless steel & 18 gauge CuVerro antimicrobial alloys
- Removable front panel. Underside to be sound deadened.
- No. 4 satin finish on interior surfaces of compartment
- Exposed exterior surfaces to have a brushed finish
- Pre-piped for easy hook up
- Integral brackets for easy installation

ALL MODELS INCLUDE:

- JSGN-6 Sensor faucet with laminar flow control
- JTM-47 thermostatic controlled mixing valve
- Cu-J-35-FS copper grid drain
- JT-150 cast brass P-trap with cleanout



Model	O.D.	I.D.
Cu-JKS-770-1	24 1/2 x 34	17 1/2 x 30 x 11
Cu-JKS-770-2	24 1/2 x 64	17 1/2 x 60 x 11
Cu-JKS-770-3	24 1/2 x 76	17 1/2 x 72 x 11

Pre-piped for easy hook up

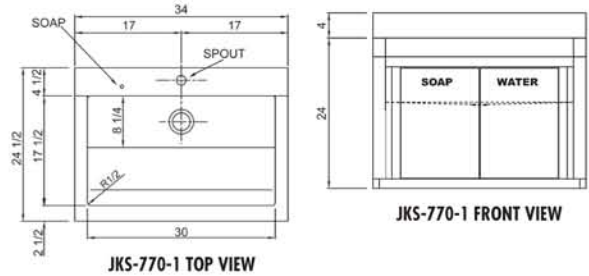

JKS-770-1 : Single Station Scrub Sink with Knee Activated Soap and Water Controls
 Includes: One (1) Knee operated water valve with spout, One (1) Soap dispenser, One (1) JTM-47 mixing valve, and One (1) Cu-J-35-FS drain system.



includes removable plexi-glass partition

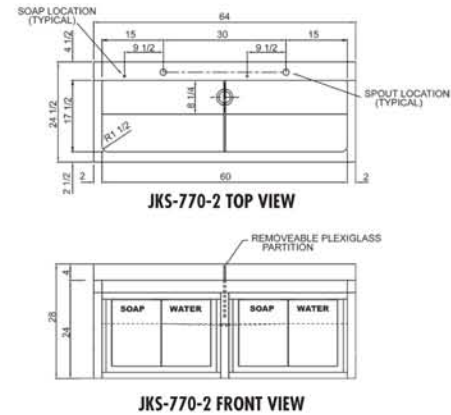

JKS-770-2 : Double Station Scrub Sink with Knee Activated Soap and Water Controls
 Includes: Two (2) Knee operated water valves with spout, Two (2) Soap dispensers, One (1) JTM-47 mixing valve, and One (1) Cu-J-35-FS drain system.



includes removable plexi-glass partition

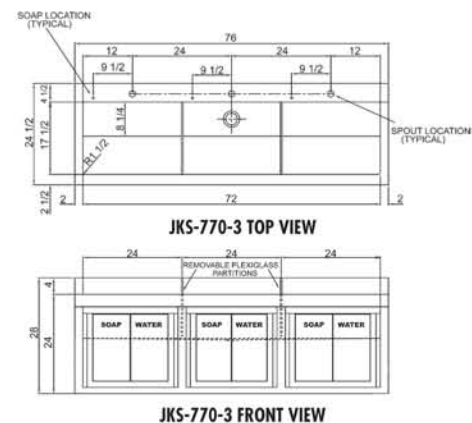

JKS-770-3: Triple Station Scrub Sink with Knee Activated Soap and Water Controls
 Includes: Three (3) Knee operated water valves with spout, Three (3) Soap dispensers, One (1) JTM-47 mixing valve, and One (1) Cu-J-35-FS drain system.

Antimicrobial Copper touch surfaces kill the microbes that cause infections where they lie. CuVerro® Antimicrobial Copper-Nickel Alloy Surfaces kill more than 99.9% of bacteria* within 2 hours, and deliver continuous and ongoing antibacterial action. CuVerro® surfaces have been shown in U.S EPA approved testing to kill five specific bacteria*. U.S. EPA registered antimicrobial copper alloys are the only class of solid surfaces that can make this claim as the antimicrobial effects of these alloys decrease as copper content decreases.

ALL MODELS INCLUDE:

- Push on/Push off knee operated water valve with spout and laminar flow control
- Knee operated soap pump
- JTM-47 thermostatic controlled mixing valve
- Cu-J-35-FS copper grid drain
- JT-150 cast brass P-trap with cleanout

TECHNICAL DATA

- 16 gauge type 304 stainless steel & 18 gauge CuVerro antimicrobial alloys
- Easy access to soap service areas. Underside to be sound deadened.
- No. 4 satin finish on interior surfaces of compartment
- Exposed exterior surfaces to have a brushed finish
- Pre-piped for easy hook up
- Integral brackets for easy installation



COVERED COPPER SURFACE SINKS



Made in the USA

Secure your ARRA (American Recovery and Reinvestment Act) project sink specifications with MADE IN USA plumbing products from Just.



Just's GREEN awareness

In plant production as well as inbound Raw materials and Packaging are factored in to our GREEN planning recycling efforts.

Manufacturing technologies not only address productivity but "in plant" environmental issues as well.

★ All Just Sinks are USA made for ARRA (American Recovery & Reinvestment Act) projects.

★ CuVerro antimicrobial alloys are comprised of pre-consumer and post-consumer recycled materials and are 100% recyclable



www.justmfg.com

The Made in USA manufacturing source for American made commercial grade plumbing fixtures.

CuVerro® Antimicrobial Copper-nickel sinks information. CuVerro antimicrobial alloys are comprised of pre-consumer and post-consumer recycled materials, and are 100% recyclable. Add this sustainability to CuVerro antimicrobial properties and flexibility and you have advantages that are truly unmatched for sinks, fixtures and hand wash stations.



The living surface metal that continuously cleans

More public and health care environments supplement current infection and disease control practices with antimicrobial copper, antibacterial products, hospital sinks, hand wash sinks and scrub sinks!

One of the most frustrating problems facing hospital infection control is how to prevent health care-acquired infections. Exposure to organisms often found in hospital environments, such as intensive care unit (ICU) rooms, can result in additional illness and sometimes death for people who come into contact with these "bugs" as many infectious diseases are transferred by touch. CuVerro Antimicrobial Copper Nickel surfaces are attractive, safe to use and never wear or wash away. Extensive laboratory testing has shown that when cleaned regularly, products made from Antimicrobial Copper:

- Kill greater than 99.9% of bacteria* within 2 hours, and continue to kill 99% of bacteria* even after repeated contamination
- Deliver continuous and ongoing antibacterial* action, remaining effective in killing greater than 99.9% of bacteria* within 2 hours.
- Help inhibit buildup and growth of bacteria* within 2 hours of exposure between routine cleaning and sanitizing steps.
- Kill greater than 99.9% of Gram-negative and Gram-positive bacteria* within 2 hours of exposure.
- Continuously reduce bacterial* contamination, achieving 99.9% reduction within 2 hours of exposure.

*Testing demonstrates effective antibacterial activity against Staphylococcus aureus, Enterobacter aerogenes, Methicillin-Resistant Staphylococcus aureus (MRSA), Escherichia coli O157:H7, and Pseudomonas aeruginosa.

CuVerro® is a registered trademark of GBC Metals, LLC and is used with permission - Document Approval #J-0003-1201

EPA registered copper alloys are the only solid surface materials that can make this claim as the inhibitive effects of copper alloys decrease as copper content of the alloys decreases.

just manufacturing
9233 king street
franklin park, il 60131

847.678.5150
justmfg.com

