



# RMW 6170

17" 1920x1080 Full HD LCD monitor  
6U Rackmount Display Panel

## User Manual

*RMW6170*: 6U 17" 1920x1080 Full HD Widescreen Industrial  
Rackmount Monitor

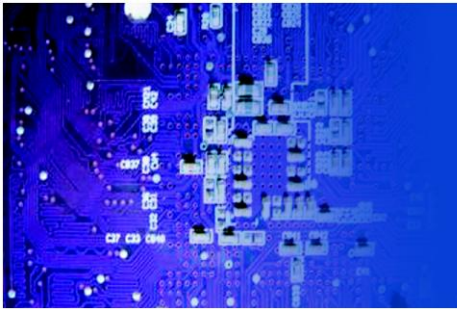

# RMW 6170

17" 1920x1080 Full HD LCD monitor  
6U Rackmount Display Panel

## Legal Information

First English printing, October 2002

Information in this document has been carefully checked for accuracy; however, no guarantee is given to the correctness of the contents. The information in this document is subject to change without notice. We are not liable for any injury or loss that results from the use of this equipment.

## Safety Instructions

**Please read all of these instructions carefully before you use the device. Save this manual for future reference.**

- | Unplug equipment before cleaning. Don't use liquid or spray detergent; use a moist cloth.
- | Keep equipment away from excessive humidity and heat. Preferably, keep it in an air-conditioned environment with temperatures not exceeding 40° Celsius (104° Fahrenheit).
- | When installing, place the equipment on a sturdy, level surface to prevent it from accidentally falling and causing damage to other equipment or injury to persons nearby.
- | When the equipment is in an open position, do not cover, block or in any way obstruct the gap between it and the power supply. Proper air convection is necessary to keep it from overheating.
- | Arrange the equipment's power cord in such a way that others won't trip or fall over it.
- | If you are using a power cord that didn't ship with the equipment, ensure that it is rated for the voltage and current labeled on the equipment's electrical ratings label. The voltage rating on the cord should be higher than the one listed on the equipment's ratings label.
- | Observe all precautions and warnings attached to the equipment.
- | If you don't intend on using the equipment for a long time, disconnect it from the power outlet to prevent being damaged by transient over-voltage.
- | Keep all liquids away from the equipment to minimize the risk of accidental spillage. Liquid spilled on to the power supply or on other hardware may cause damage, fire or electrical shock.
- | Only qualified service personnel should open the chassis. Opening it yourself could damage the equipment and invalidate its warranty.
- | If any part of the equipment becomes damaged or stops functioning, have it checked by qualified service personnel.

## What the warranty does not cover

- | Any product, on which the serial number has been defaced, modified or removed.
- | Damage, deterioration or malfunction resulting from:
  - ? Accident, misuse, neglect, fire, water, lightning, or other acts of nature, unauthorized product modification, or failure to follow instructions supplied with the product.
  - ? Repair or attempted repair by anyone not authorized by us.
  - ? Any damage of the product due to shipment.
  - ? Removal or installation of the product.
  - ? Causes external to the product, such as electric power fluctuation or failure.
  - ? Use of supplies or parts not meeting our specifications.
  - ? Normal wear and tear.
  - ? Any other causes which does not relate to a product defect.
- | Removal, installation, and set-up service charges.

## Regulatory Notices Federal Communications Commission (FCC)

This equipment has been tested and found to comply with the limits for a Class B digital device, pursuant to Part 15 of the FCC rules. These limits are designed to provide reasonable protection against harmful interference in a residential installation.

Any changes or modifications made to this equipment may void the user's authority to operate this equipment. This equipment generates, uses, and can radiate radio frequency energy and, if not installed and used in accordance with the instructions, may cause harmful interference to radio communications.

However, there is no guarantee that interference will not occur in a particular installation. If this equipment does cause harmful interference to radio or television reception, which can be determined by turning the equipment off and on, the user is encouraged to try to correct the interference by one or more of the following measures:

- | Re-position or relocate the receiving antenna.
- | Increase the separation between the equipment and receiver.
- | Connect the equipment into an outlet on a circuit different from that to which the receiver is connected.

**ACNODES**

14628 Central Ave,  
Chino, CA 91710  
tel:909.597.7588, fax:909.597.1939

© Copyright 2013 Acnodes, Inc.

All rights reserved. Product description and product specifications are subject to change without notice. For latest product information, please visit Acnodes' web site at [www.acnodes.com](http://www.acnodes.com).



# RMW 6170

17" 1920x1080 Full HD LCD monitor  
6U Rackmount Display Panel

## Contents

### < Part. 1 > RMW6170

1.1	Package Content	P.1
1.2	Structure Diagram & Dimension	P.1 - 2
1.3	Installation	P.3

### < Part. 2 > Specifications / OSD / Remote Controller

2.1	Product Specifications	P.4 - 5
2.2	On-screen Display Operation ( OSD )	P.6 - 7
2.3	Picture In Picture ( PIP ) / Picture By Picture ( PBP )	P.8 - 9

### < Part. 3 > Options

3.1	3G / HD / SD- <b>SDI</b> Broadcast-grade input	P.10
3.2	<b>MCS</b> Multi-display control solution	P.11
3.3	<b>AV3.0</b> Upgrade : DVI-D + VGA + HDMI + BNC + S-Video + Audio	P.12
3.4	F17" Touchscreen : Resistive	P.13
3.5	48V, 24V or 12VDC power	P.14
3.6	MIL-type or lockable connector	P.15



# RMW 6170

17" 1920x1080 Full HD LCD monitor  
6U Rackmount Display Panel

## Before Installation

- | It is very important to mount the equipment in a suitable cabinet or on a stable surface.
- | Make sure the place has a good ventilation, is out of direct sunlight, away from sources of excessive dust, dirt, heat, water, moisture and vibration.

## Unpacking

The equipment comes with the standard parts shown in package content. Check and make sure they are included and in good condition. If anything is missing, or damaged, contact the supplier immediately.

## How To Clean Your LCD Monitor

### Caution :

- | To avoid the risk of electric shock, make sure your hands are dry before unplugging your monitor from or plugging your monitor into an electrical outlet.
- | When you clean your monitor, do not press down on the LCD screen. Pressing down on the screen can scratch or damage your display. Pressure damage is not covered under warranty.
- | Use only cleansers made specifically for cleaning monitors and monitor screens. Cleansers not made to clean monitors and monitor screens can scratch the LCD display or strip off the finish.
- | Do not spray any kind of liquid directly onto the screen or case of your monitor. Spraying liquids directly onto the screen or case can cause damage which is not covered under warranty.
- | Do not use paper towels or abrasive pads to clean your monitor. Using an abrasive pad or any wood based paper product such as paper towels can scratch your LCD screen.

## Cleaning Your Monitor

To clean your LCD safely, please follow these steps :

- ① Disconnect the power cord.
- ② Gently wipe the surface using a clean, dry microfiber cloth. Use as little pressure as possible.

## Cleaning Tough Marks and Smudges

To remove tough marks and smudges, please follow these steps :

- ① Disconnect the power cord.
- ② Spray a small amount of non-abrasive cleanser on a microfiber cloth.

 **Caution : Do not spray or apply any liquids directly onto the monitor. Always apply the solution to your microfiber cloth first, not directly on the parts you are cleaning.**

- ③ Gently wipe the surface. Use as little pressure as possible.
- ④ Wait until your monitor is completely dry before plugging it in and powering it up.

# RMW 6170

17" 1920x1080 Full HD LCD monitor  
6U Rackmount Display Panel

## < Part 1 >

### < 1.1 > Package Content



#### RMW6170 unit X 1

- 6ft VGA cable X 1
- Power adapter X 1
- Power cord X 1

### < 1.2 > Structure Diagram

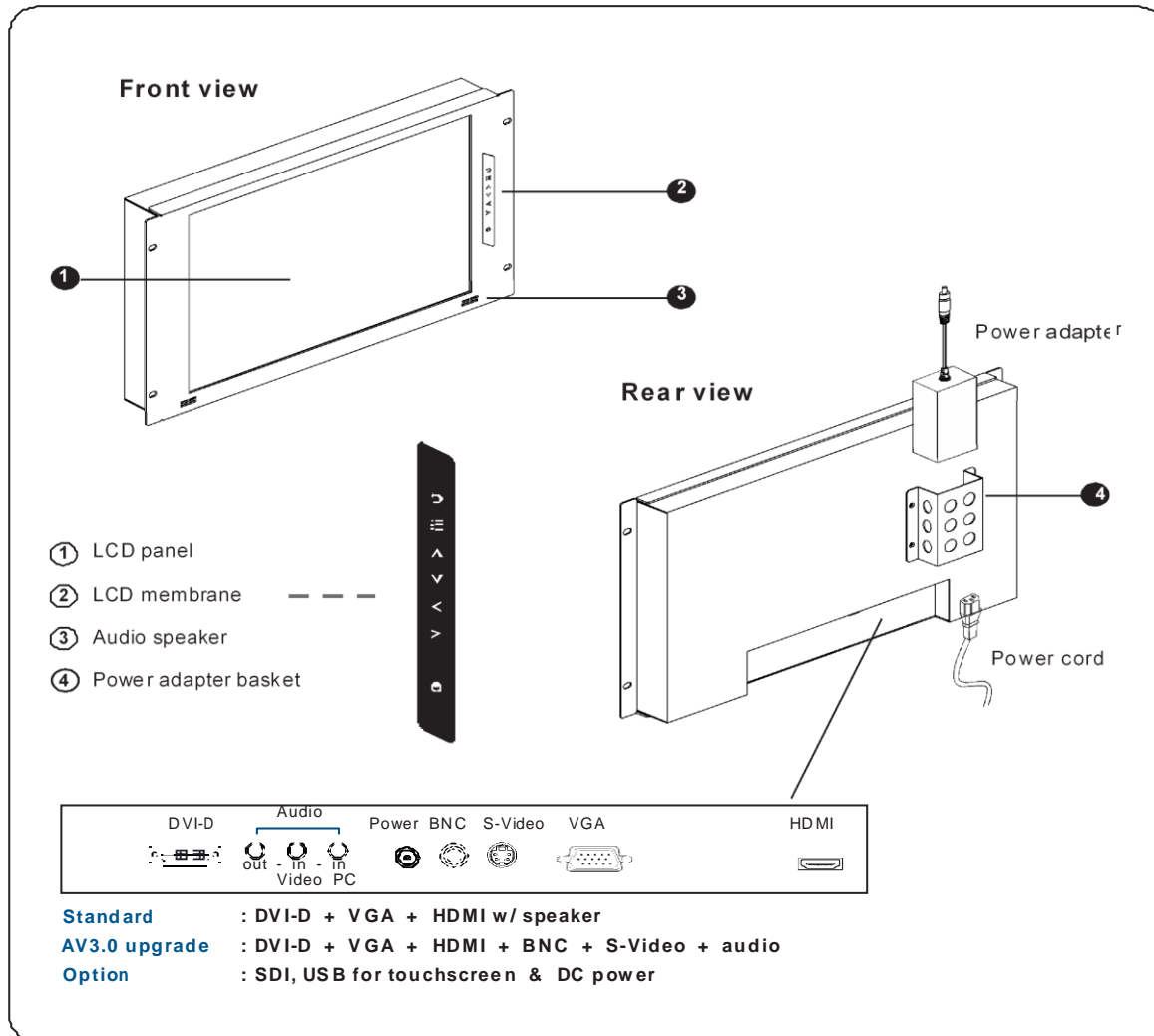

# RMW 6170

17" 1920x1080 Full HD LCD monitor  
6U Rackmount Display Panel

## < 1.2 > Dimension

Front View

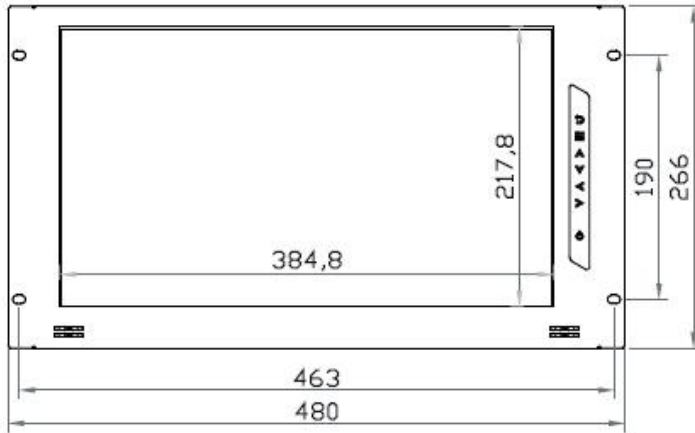

Side View

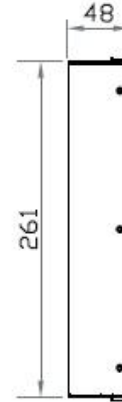

Bottom View

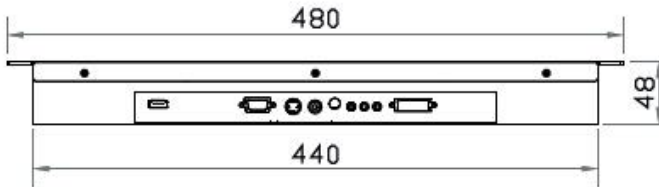

UNIT : mm  
1mm = 0.03937 inch

Model	Product Dimension (W x D x H)	Packing Dimension (W x D x H)	Net Weight	Gross Weight
RMW6170	480 x 48 x 266 mm 18.9 x 1.9 x 10.5 inch	529 x 124 x 451 mm 20.8 x 4.9 x 17.8 inch	4.5 kg 9.9 lbs	6 kg 13.2 lbs

# RMW 6170

17" 1920x1080 Full HD LCD monitor  
6U Rackmount Display Panel

## < 1.3 > Installation

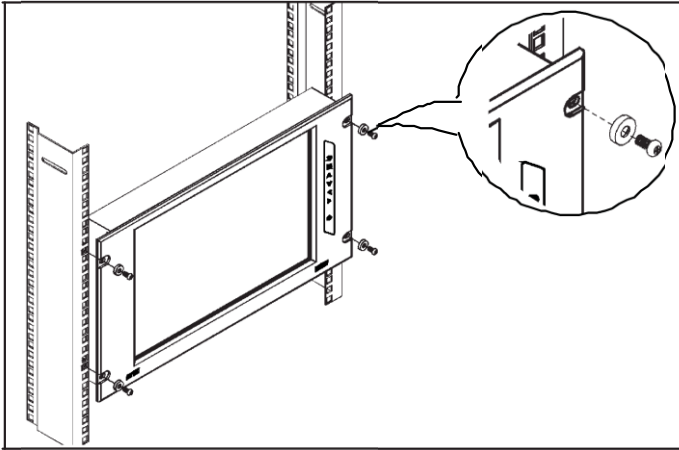

### Step 1

- Mount the display panel with M6 screw set.
- M6 screw x 4 pcs required ( Left & right side ).

**M6 screw sets are not provided.**

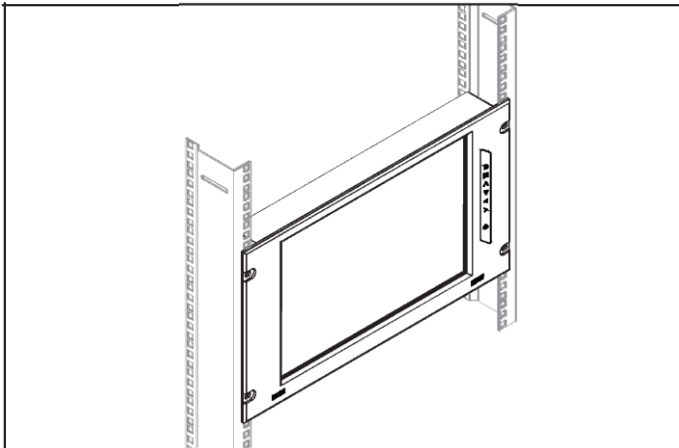

### Step 2

- Fix the LCD into the rack.

# RMW 6170

17" 1920x1080 Full HD LCD monitor  
6U Rackmount Display Panel

## < Part 2 >

### < 2.1 > Product Specifications

LCD Panel	Panel Size ( diagonal )	17.3-inch Widescreen TFT color LCD
	Display pixel ( dots x lines )	1920 x 1080
	Brightness ( typ. )	300
	Contrast Ratio ( typ. )	600:1
	Color	1.07 Billion, 10-bit
	Viewing Angle ( L/R/U/D )	89/89/89/89
	Response Time ( ms )	35
	Dot pitch ( mm )	0.199
	Display Area ( mm )	381.9H x 214.8V
	Surface treatment	Anti-glare, Hard-coating
	Surface hardness	3H
	Backlight Type	LED
MTBF ( hrs )	20,000	

Video Connectivity	Digital	HDMI DVI	HDMI 1.1, CEA-861-D DVI-D, TMDS single link
	Analog	VGA Composite ( BNC ) S-Video ( 4-pin )	Analog 0.7Vp-p NTSC & PAL NTSC & PAL
	Plug & Play	DVI / VGA	VESA EDID structure 1.3
	Synchronization	VGA	Separate, Composite & SOG

Audio Connectivity	Audio Input	Connector Impedance / Power level	3.5mm stereo jack 30k $\Omega$ / 750mV
	Audio Output	Connector Resistance / Power level	3.5mm stereo jack 30k $\Omega$ / 2.8V
	Speaker Output	Power	2 x 2W

\*When the audio output is connected, speaker output is OFF



# RMW 6170

17" 1920x1080 Full HD LCD monitor  
6U Rackmount Display Panel

<b>Power</b>	Power Supply	Range	Auto-sensing 100 to 240VAC, 50 / 60Hz
	Power Consumption	Screen display ON	34W or less
		Power saving mode	4W or less
Power button OFF		1W or less	

<b>Regulatory</b>	Safety Approval	FCC & CE
-------------------	-----------------	----------

<b>Environmental Conditions</b>	Operating	Temperature Humidity	0 to 50°C degree 20~90%, non-condensing
	Storage	Temperature Humidity Shock Vibration	-5 to 60°C degree 5~90%, non-condensing 10G acceleration (11ms duration) 5~500Hz 1G RMS random

<b>Physical Specification</b>	Product ( W x D x H )	480 x 48 x 266 mm 18.9 x 1.9 x 10.5 inch
	Packing ( W x D x H )	529 x 124 x 451 mm 20.8 x 4.9 x 17.8 inch
	Net Weight	4.5 kgs / 9.9 lbs
	Gross Weight	6 kgs / 13.2 lbs

<b>Applicable Format</b>	DVI-D/ VGA Input	PC Signal	1920 x 1080 x 60Hz
			1280 x 1024 x 60 / 75Hz
			1280 x 960 x 60Hz
			1280 x 768 x 60 / 75Hz
			1152 x 864 x 75Hz
			1024 x 768 x 60 / 70 / 75Hz
			848 x 480 x 60Hz
			800 x 600 x 60 / 72 / 75Hz
			720 x 400 x 70Hz
			640 x 480 x 60 / 72 / 75Hz
			640 x 400 x 70Hz
640 x 350 x 70Hz			



# RMW 6170







17" 1920x1080 Full HD LCD monitor  
6U Rackmount Display Panel

<b>Applicable Format</b>	HDMI Input	PC Signal Video Signal	Same as VGA
			1080p : 60Hz
			720p : 50 / 60Hz
			480p : 60Hz
		Audio Signal	576p : 50Hz
			2ch Linear PCM ( 32 / 44.1 / 48 KHz )



# RMW 6170

17" 1920x1080 Full HD LCD monitor  
6U Rackmount Display Panel

## < 2.2 > On-screen Display Operation ( OSD )

Membrane Switch	Function
	Turn the monitor on or off
	Display the OSD menu Act as an Enter key to select screen setting options
   	Scroll through menu options and adjust the displayed control
	Exit the OSD screen Go back to the previous on-screen sub-menu or main menu

Remark : All LED touch buttons in **WHITE** light.  
The LED of **Power**  touch button will flash continuously when there is no signal input.

- All the LED touch buttons will automatically turn off after 10 minutes of idle status ( except the **Power**  ).
- Light up all membrane buttons, please press any button for 1 - 2 seconds ( except the **Power**  ).

### ① Picture

- Picture mode : Standard / Vivid / Soft / User mode to choose
- Brightness : Adjust background black level of the screen image
- Contrast : Adjust the difference between the image background (black level) and the foreground (white level)
- Hue: Adjust the screen hue value
- Saturation : Adjust the saturation of the image color
- Picture size : Adjust the image size
- Color temp : Standard / Cool / Warm / User to choose
- Noise reduce : Reduce the noise of the image
- Sharpness : Adjust the image from weak to sharp

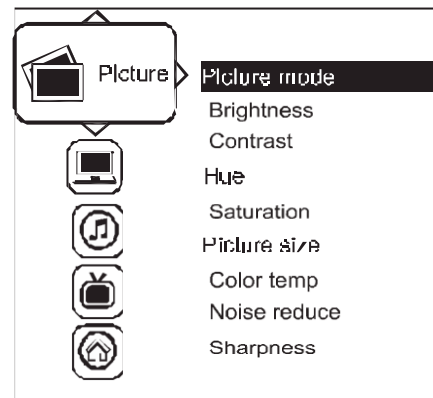

# RMW 6170

17" 1920x1080 Full HD LCD monitor  
6U Rackmount Display Panel

## < 2.2 > On-screen Display Operation ( OSD )

### ② PC

Auto adjust :	Automatically adjust sizes, centers and fine tunes the video signal to eliminate waviness and distortion.
Clock :	Adjust the clock value
Phase :	Adjust the phase value
H. Position :	Align the screen image left or right
V. Position :	Align the screen image up or down

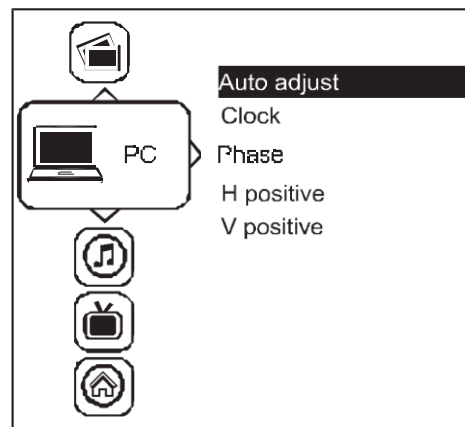

### ③ Audio

Audio mode :	Movie / Voice / Normal / Music mode to choose
Volume :	Adjust the volume of sound
Bass :	Set the value of bass sound
Treble :	Set the value of treble sound
Balance :	Set the balance value of treble and bass sound
Analog TV audio :	Set the value of analog TV audio sound
Mute :	Turn off the surrounding sound

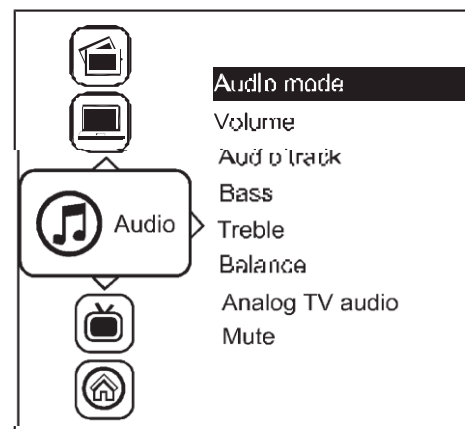

### ④ MISC

Language :	Select the language in which the OSD menu is displayed - English
Sleep timer :	Set the off time
PIP mode :	Adjust picture in picture setting
PIP position :	Enter into PIP position
PIP source :	Enter into the Sub source and sound source
System reset :	Return the adjustment back to factory setting
Information :	Select for Help

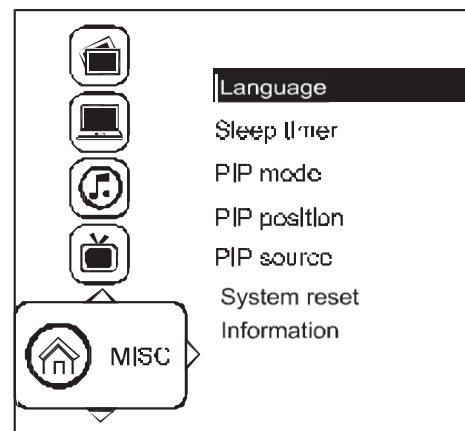

# RMW 6170

17" 1920x1080 Full HD LCD monitor  
6U Rackmount Display Panel

## < 2.3 > How to Use Picture In Picture ( PIP ) / Picture By Picture ( PBP )

### < 2.3.1 > Picture in Picture ( PIP )

#### Mode

Display the Sub screen in the Main screen.

OSD Menu ? MISC ? PIP Mode ? Large / Small / OFF

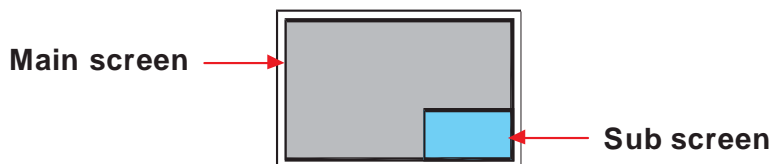

#### Position

Adjust the position of the Sub screen ( top left, bottom left, top right, bottom right )

OSD Menu ? MISC ? PIP Position ? top left / top right / bottom left / bottom right

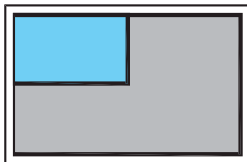

top left

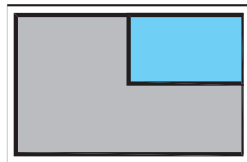

top right

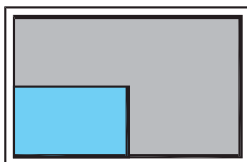

bottom left

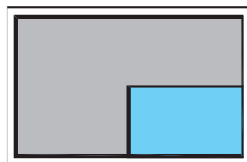

bottom right

#### Size

Adjust the size of the Sub screen ( Large / Small )

OSD Menu ? MISC ? PIP Mode ? Large / Small

#### Size of Sub screen

LCD Monitor	Large Sub screen	Small Sub screen
1920 x 1200	552 x 414	480 x 360
1920 x 1080	552 x 414	480 x 360
1440 x 900	414 x 310	360 x 270
1366 x 768	392 x 294	340 x 254
1280 x 1024	368 x 276	320 x 240

# RMW 6170

17" 1920x1080 Full HD LCD monitor  
6U Rackmount Display Panel

## < 2.3.2 > Picture By Picture ( PBP )

### Mode

Display the Sub screen next to the Main screen.

OSD Menu ? MISC ? PIP Mode ? PBP



### Size

LCD Monitor	Main / Sub screen
1920 x 1200	955 x 716
1920 x 1080	955 x 716
1440 x 900	715 x 536
1366 x 768	678 x 508
1280 x 1024	635 x 476

## < 2.3.3 > PIP / PBP Source

To select an input signal for PIP / PBP Sub screen.

OSD Menu ? MISC ? PIP Source ? VGA / S-Video / Composite / DVI / HDMI / SDI / YPbPr / TV

The PIP/ PBP is operable in the following table :

Main	Sub	VGA	S-Video	Composite	DVI-D	HDMI	SDI	YPbPr	TV
VGA		X	O	O	O	O	O	O	O
S-Video		O	X	X	O	O	O	O	X
Composite		O	X	X	O	O	O	O	X
DVI		O	O	O	X	X	O	O	O
HDMI		O	O	O	X	X	O	O	O
SDI		O	O	O	O	O	X	X	O
YPbPr		O	O	O	O	O	X	X	O
TV		O	X	X	O	O	O	O	X

# RMW 6170

17" 1920x1080 Full HD LCD monitor  
6U Rackmount Display Panel

## < Part 3 >

### < 3.1 > Options : 3G / HD / SD-SDI input



SDI input is an ideal solution for the broadcast- grade video and high resolution CCTV market.

Designed for use with Full HD 1080p and ultra high resolution 1920 x 1200 LCD displays, Austin Hughes provides a SDI input module without using additional space or power and it comes standard with a 2-year warranty.

### SDI

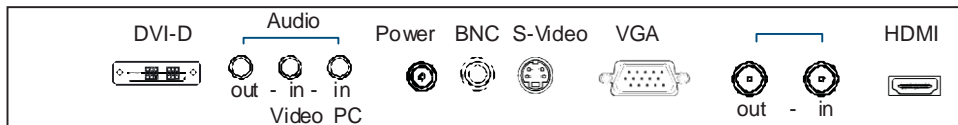

\*\*\* For **SDI** option, the AD board will be upgraded to AV3.0, and this comes standard with HDMI, DVI-D, VGA, S-Video, BNC and audio inputs.

<b>INPUT</b>	3G-SDI IN	BNC x 1 / 0.8Vp-p ( 75 ohm )
	3G-SDI OUT	BNC x 1 / Active through, equalized & relocked

<b>Standard Compliance</b>	Video	SMPTE 425M / 274M / 296M / 125M ITU-R BT.656
	Audio	SMPTE 299M / 272M-C

<b>Compatible Video Format</b>	3G-SDI	1080p @60 / 50Hz, 4:2:2
		1080p @30 / 25 / 24Hz, 4:4:4
		1080i @60 / 50Hz, 4:4:4
		720p @60 / 50Hz, 4:4:4
	HD-SDI	1080p @30 / 25 / 24Hz, 4:2:2
		1080i @60 / 50Hz, 4:2:2
720p @60 / 50Hz, 4:2:2		
SD-SDI	480i @60Hz, 4:2:2	
ITU-R BT.656	576i @50Hz, 4:2:2	

<b>Compatible Audio Format</b>	3G-SDI	48kHz, 16 / 20 / 24 bit, 2 CH, Synchronized Video
	HD-SDI	48kHz, 16 / 20 / 24 bit, 2 CH, Synchronized Video
	SD-SDI	48kHz, 16 / 20 / 24 bit, 2 CH, Synchronized / Asynchronized Video

<b>Max. Transmission Distance 75 ohm coaxial cable</b>	3G-SDI	150m at 2.97Gb/s
	HD-SDI	250m at 1.485Gb/s
	SD-SDI	480m at 270Mb/s

# RMW 6170

17" 1920x1080 Full HD LCD monitor  
6U Rackmount Display Panel

## < 3.2 > Options : MCS ( Multi-display Control )



More control is always good. Especially when it is necessary and easy. Acnodes Corp. provides MCS solution to control the **OSD** of various LCD display up to 64 units.

The RS-232C is used for the communication between the PC and the first display via a 15 feet serial cable while the CAN bus is used for the various LCD displays cascade together via CAT 5/6 cable, and daisy chain up to 1,000 meters.

Designed for use with various LCD displays, Acnodes provides a MCS input module without using additional space or power and it comes standard with a 2-year warranty.

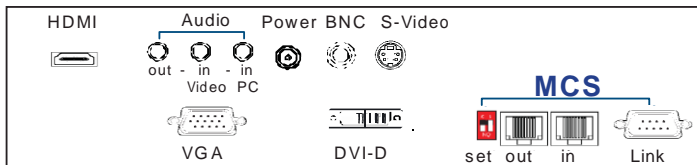

\*\*\* Please download the protocol of MCS control at :

\*\*\* For **MCS** option, casing depth will be changed.

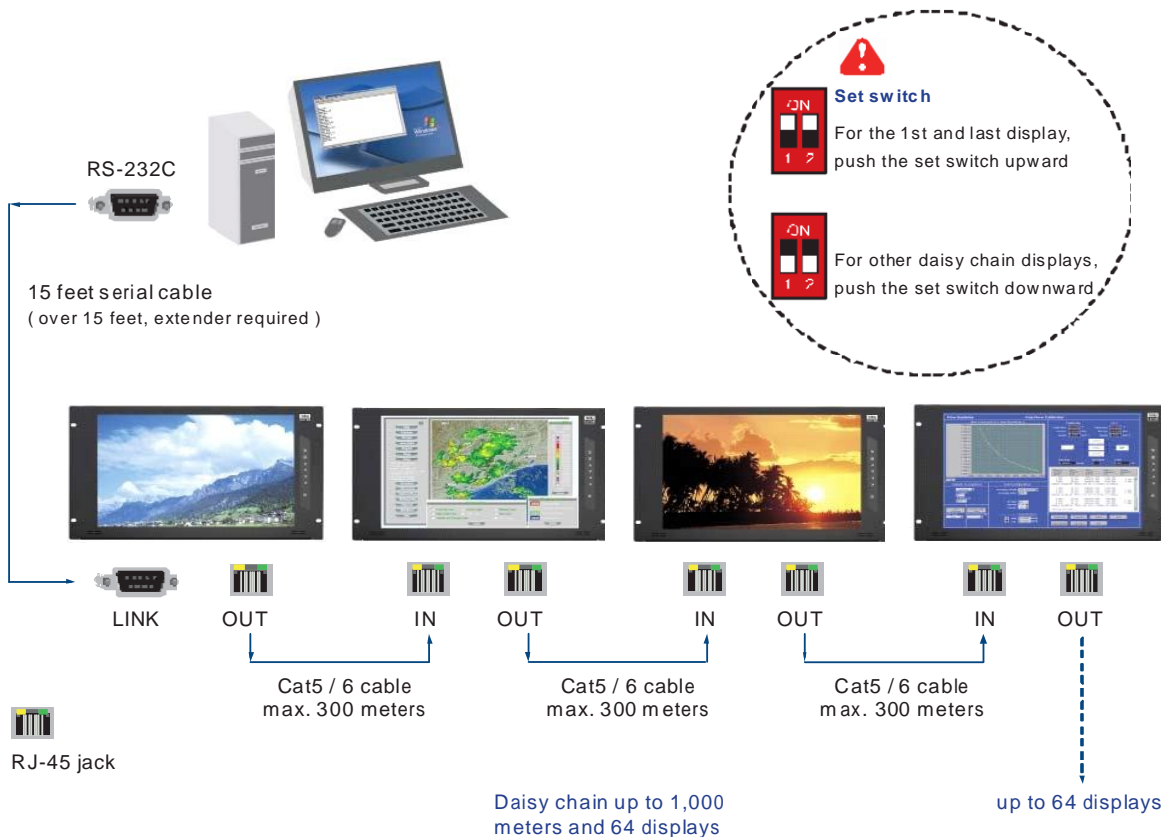



# RMW 6170

17" 1920x1080 Full HD LCD monitor  
6U Rackmount Display Panel

## < 3.3 > AV3.0 Upgrade Options :

- **AV** ( S-Video + Composite, BNC )
- **Audio** ( 3.5mm audio jacks for audio in & out, and 2W + 2W speakers

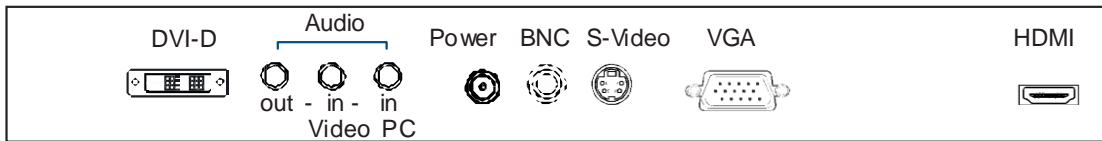

## < 3.4 > Options : Touchscreen & driver



### F17" USB Touchscreen Specification

Model	TRB e-Resistive
Technology	5-Wire Resistive
Touch Point	Single
Method	Stylus or Finger
Activation Force	= 50g / Stylus=R0.8
Durability Response	10 million touches
Time Optical	15 ms
Transmittance Surface	80% ± 3%
Hardness Haze	3H
Glass	8% ± 3%
Connector	2.2 ± 0.2 mm
Compatibility	USB Type A
	Windows 7 / XP / Vista, Linux

- USB touchscreen package includes 1 x 6ft USB cable, quick reference guideline and CD disc
- For detailed information, please refer to the attached CD disc
- As the touchscreen unit is not made of toughened glass, please handle it carefully

## USB Touchscreen



# RMW 6170

17" 1920x1080 Full HD LCD monitor  
6U Rackmount Display Panel

## Please follow the below steps to setup the touch screen:-

**Step 1.** Run the bundled CD disc

**Step 2.** Double click the Setup.exe

**Step 3.** Follow the installation instruction to finish the setup

**Step 4.** After installation, run the TouchKit program & the "4 point calibration"



Please do the initial calibration  
after the first setup

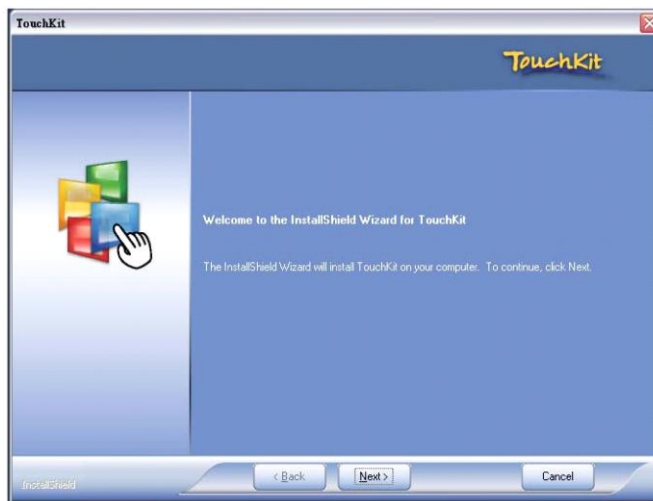



# RMW 6170

17" 1920x1080 Full HD LCD monitor  
6U Rackmount Display Panel

## < 3.5 > Options : DC Power

Model	12V	24V	48V
<b>Input rating</b>			
Input voltage:	12-Volt	24-Volt	48-Volt
Input range:	9 ~ 18V	18 ~ 36V	36 ~ 75V
Input current			
- No load	50 mA	50 mA	50 mA
- Full load	4950 mA	2450 mA	1220 mA
<b>Output rating</b>			
Output voltage:	12-Volt	12-Volt	12-Volt
Output current:	4.16A	4.16A	4.16A
<b>Efficiency</b>	84%	85%	85%



# RMW 6170

17" 1920x1080 Full HD LCD monitor  
6U Rackmount Display Panel

## < 3.6 > Options : MIL-type or Lockable Connector

	Input	Part no.	MIL Standard
MIL - type Connector	DC Power *** ( Male )	MS3470W8-33P 	MIL - DTL - 26482
	VGA *** ( Male )	MS3470W14-15P 	MIL - DTL - 26482

\*\*\* There are several additional MIL DC and VGA connector types with varying design characteristics to meet cost considerations and to provide users with the most design flexibility possible. For more information, please contact us.

	Input	Part no.	Standard
Lockable Connector	DC Power ( Male )	YM-Ext-461CP001 	D-type 3W3
	USB	LUSB - A111 - 00 	-

\*\*\* MIL - type or Lockable connectors above can be integrated with our LCD displays. Sale service just for connectors not provided.