



APW5173

Industrial Panel Mount Monitor

User Manual

APW5173: 17.3" 1920x1080 Widescreen Industrial
Panel Mount Monitor

Legal Information

First English printing, October 2002

Information in this document has been carefully checked for accuracy; however, no guarantee is given to the correctness of the contents. The information in this document is subject to change without notice. We are not liable for any injury or loss that results from the use of this equipment.

Safety Instructions

Please read all of these instructions carefully before you use the device. Save this manual for future reference.

- Unplug equipment before cleaning. Don't use liquid or spray detergent; use a moist cloth.
- Keep equipment away from excessive humidity and heat. Preferably, keep it in an air-conditioned environment with temperatures not exceeding 40° Celsius (104° Fahrenheit).
- When installing, place the equipment on a sturdy, level surface to prevent it from accidentally falling and causing damage to other equipment or injury to persons nearby.
- When the equipment is in an open position, do not cover, block or in any way obstruct the gap between it and the power supply. Proper air convection is necessary to keep it from overheating.
- Arrange the equipment's power cord in such a way that others won't trip or fall over it.
- If you are using a power cord that didn't ship with the equipment, ensure that it is rated for the voltage and current labeled on the equipment's electrical ratings label. The voltage rating on the cord should be higher than the one listed on the equipment's ratings label.
- Observe all precautions and warnings attached to the equipment.
- If you don't intend on using the equipment for a long time, disconnect it from the power outlet to prevent being damaged by transient over-voltage.
- Keep all liquids away from the equipment to minimize the risk of accidental spillage. Liquid spilled on to the power supply or on other hardware may cause damage, fire or electrical shock.
- Only qualified service personnel should open the chassis. Opening it yourself could damage the equipment and invalidate its warranty.
- If any part of the equipment becomes damaged or stops functioning, have it checked by qualified service personnel.

What the warranty does not cover

- Any product, on which the serial number has been defaced, modified or removed.
- Damage, deterioration or malfunction resulting from:
 - Accident, misuse, neglect, fire, water, lightning, or other acts of nature, unauthorized product modification, or failure to follow instructions supplied with the product.
 - Repair or attempted repair by anyone not authorized by us.
 - Any damage of the product due to shipment.
 - Removal or installation of the product.
 - Causes external to the product, such as electric power fluctuation or failure.
 - Use of supplies or parts not meeting our specifications.
 - Normal wear and tear.
 - Any other causes which does not relate to a product defect.
- Removal, installation, and set-up service charges.

Regulatory Notices Federal Communications Commission (FCC)

This equipment has been tested and found to comply with the limits for a Class B digital device, pursuant to Part 15 of the FCC rules. These limits are designed to provide reasonable protection against harmful interference in a residential installation.

Any changes or modifications made to this equipment may void the user's authority to operate this equipment. This equipment generates, uses, and can radiate radio frequency energy and, if not installed and used in accordance with the instructions, may cause harmful interference to radio communications.

However, there is no guarantee that interference will not occur in a particular installation. If this equipment does cause harmful interference to radio or television reception, which can be determined by turning the equipment off and on, the user is encouraged to try to correct the interference by one or more of the following measures:

- Re-position or relocate the receiving antenna.
- Increase the separation between the equipment and receiver.
- Connect the equipment into an outlet on a circuit different from that to which the receiver is connected.

Contents

< Part. 1 > APW5173

1.1	Package Content	P.1
1.2	Structure Diagram & Dimension	P.2 - 3
1.3	Mounting Hardware & Installation	P.4 - 5

< Part. 3 > Specifications / OSD / Remote Controller

3.1	Product Specifications	P.6 - 7
3.2	On-screen Display Operation (OSD)	P.8 - 9
3.3	Picture In Picture (PIP) / Picture By Picture (PBP)	P.10 - 11

< Part. 4 > Options

4.1	Option Table	P.12
4.2	3G / HD / SD-SDI Broadcast-grade input	P.13
4.3	MCS Multi-display control solution	P.14
4.4	AV3.0 Upgrade : S-Video + BNC & Audio	P.15 - 16
4.5	Resistive (single point touch)	P.17 - 18
4.6	48V, 24V or 12VDC power	P.19
4.7	MIL-type or lockable connector	P.20
4.8	TV (Analog)	P.21 - 22

Before Installation

- It is very important to mount the equipment in a suitable cabinet or on a stable surface.
- Make sure the place has a good ventilation, is out of direct sunlight, away from sources of excessive dust, dirt, heat, water, moisture and vibration.

Unpacking

The equipment comes with the standard parts shown in package content. Check and make sure they are included and in good condition. If anything is missing, or damaged, contact the supplier immediately.

How To Clean Your LCD Monitor



Caution :

- To avoid the risk of electric shock, make sure your hands are dry before unplugging your monitor from or plugging your monitor into an electrical outlet.
- When you clean your monitor, do not press down on the LCD screen. Pressing down on the screen can scratch or damage your display. Pressure damage is not covered under warranty.
- Use only cleansers made specifically for cleaning monitors and monitor screens. Cleansers not made to clean monitors and monitor screens can scratch the LCD display or strip off the finish.
- Do not spray any kind of liquid directly onto the screen or case of your monitor. Spraying liquids directly onto the screen or case can cause damage which is not covered under warranty.
- Do not use paper towels or abrasive pads to clean your monitor. Using an abrasive pad or any wood based paper product such as paper towels can scratch your LCD screen.

Cleaning Your Monitor

To clean your LCD safely, please follow these steps :

- ① Disconnect the power cord.
- ② Gently wipe the surface using a clean, dry microfiber cloth. Use as little pressure as possible.

Cleaning Tough Marks and Smudges

To remove tough marks and smudges, please follow these steps :

- ① Disconnect the power cord.
- ② Spray a small amount of non-abrasive cleanser on a microfiber cloth.



Caution : Do not spray or apply any liquids directly onto the monitor. Always apply the solution to your microfiber cloth first, not directly on the parts you are cleaning.

- ③ Gently wipe the surface. Use as little pressure as possible.
- ④ Wait until your monitor is completely dry before plugging it in and powering it up.

< Part 1 >

< 1.1 > Package Content

APW5173



17" FHD LCD display X 1

6ft VGA cable X 1

Power cord X 1

Remote controller X 1

Mounting hardware X 1 pack

- Mounting bracket x 4 pcs

- M4* 6mm screw x 8 pcs

- M4* 50mm screw x 8 pcs

Basic I/O

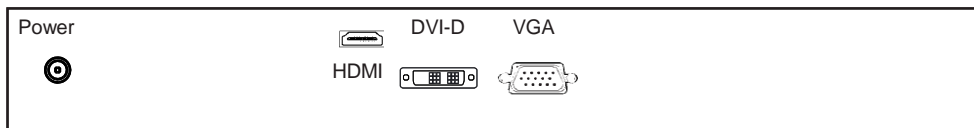

AV3.0 upgrade I/O with advanced features

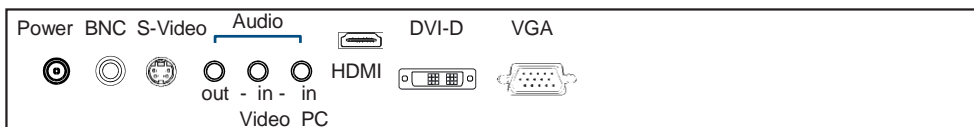

- An abundance of input connections that include HDMI, DVI-D, VGA, S-Video + BNC and audio
- On-chip Faroudja® DCDi Cinema processing

< 1.2 > Structure Diagram

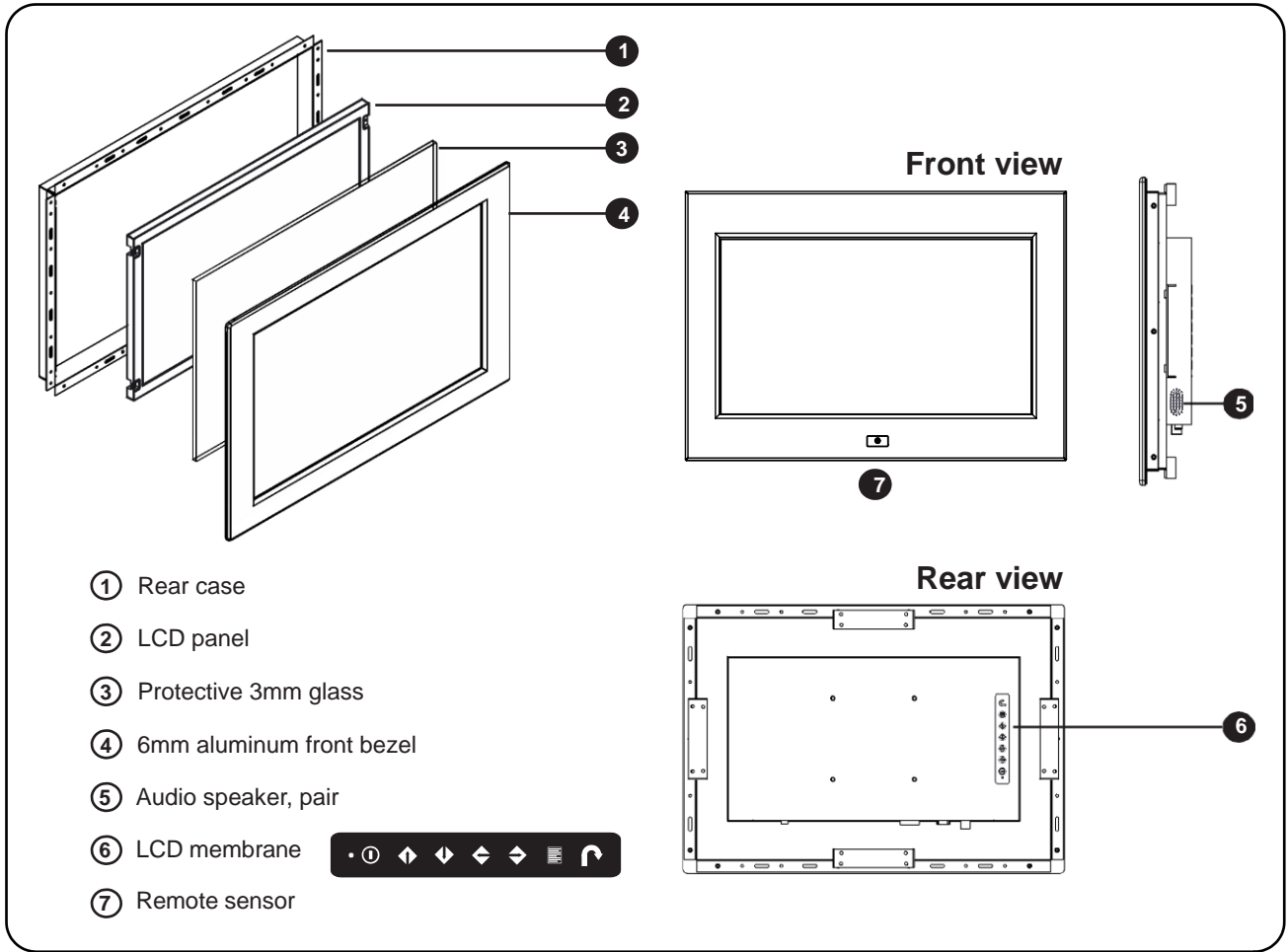

Model	Product Dimension (W x D x H)	Packing Dimension (W x D x H)	Net Weight	Gross Weight
APW5173	468.5 x 57.1 x 331 mm 18.4 x 2.2 x 13 inch	615 x 113 x 523 mm 24.2 x 4.4 x 20.6 inch	5.2 kg 11.4 lbs	8 kg 17.6 lbs

< 1.2 > Dimension

Front View

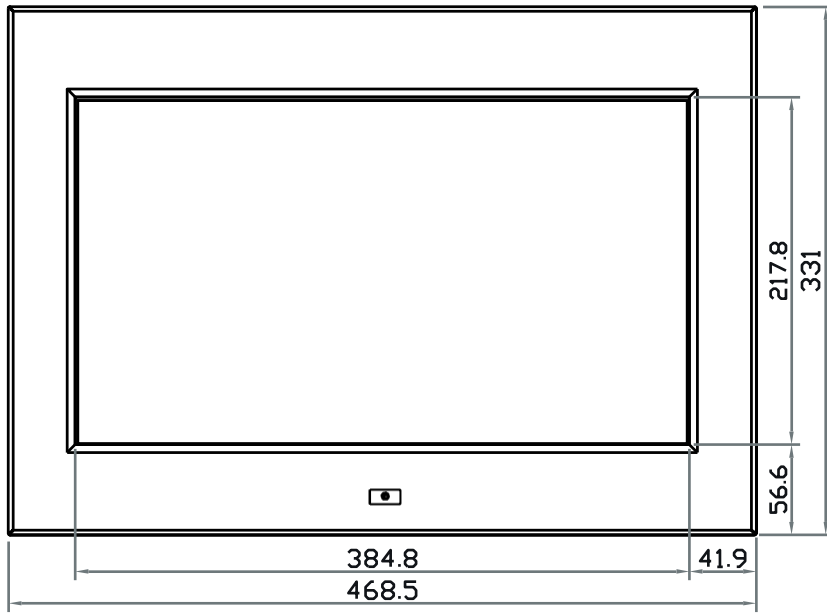

Side View

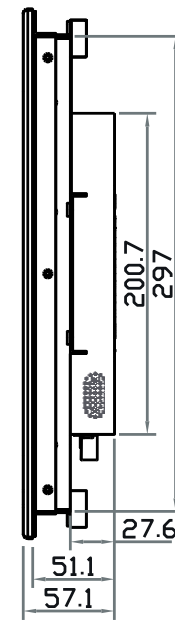

Rear View

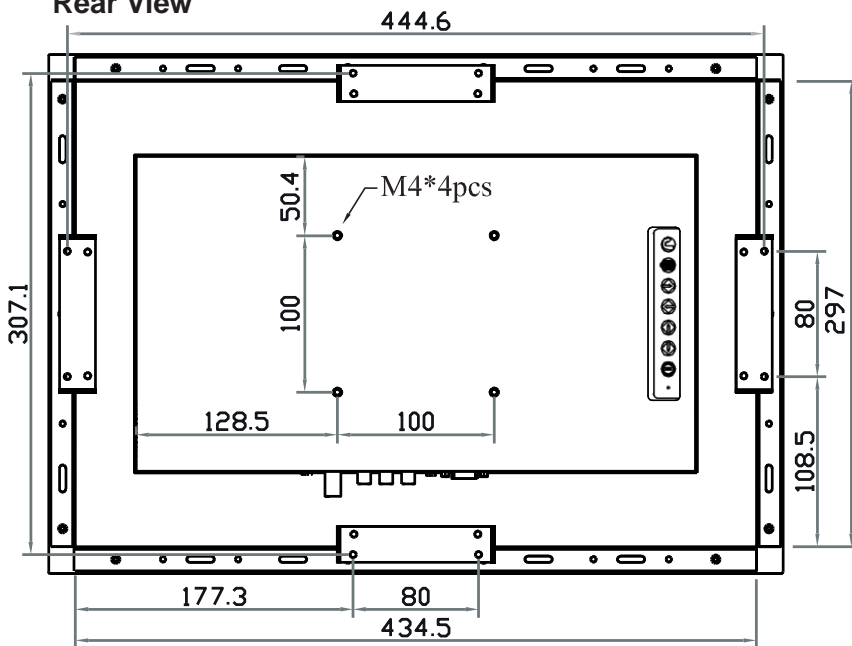

UNIT : mm
1mm = 0.03937 inch

Bottom View

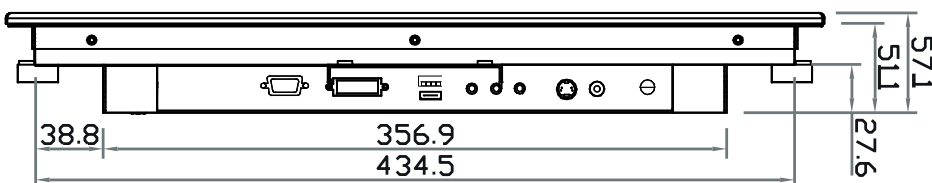

< 1.3 > Panel Mount Installation

- 1 Mounting bracket
x 4 pcs

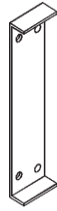

- 2 M4*6mm screw
x 8 pcs



- 3 M4*50mm screw
x 8 pcs

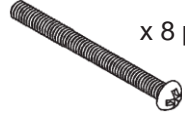

Hardware set part no. UV-BK#2

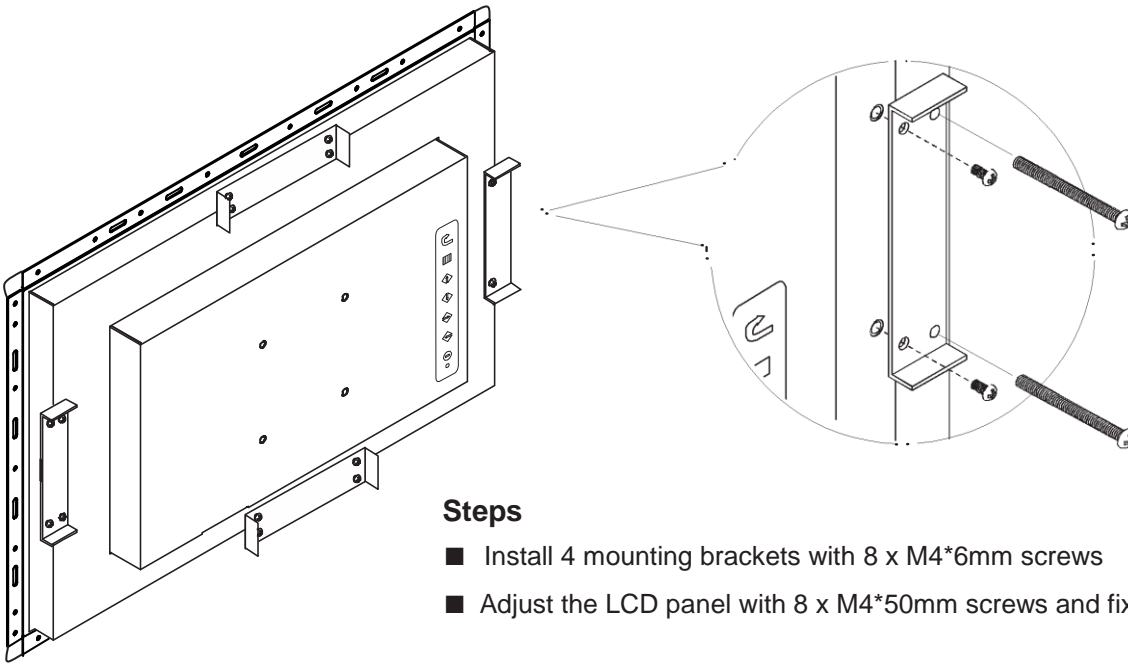

Steps

- Install 4 mounting brackets with 8 x M4*6mm screws
- Adjust the LCD panel with 8 x M4*50mm screws and fix it on the surface.

< 1.3 > VESA mount Installation

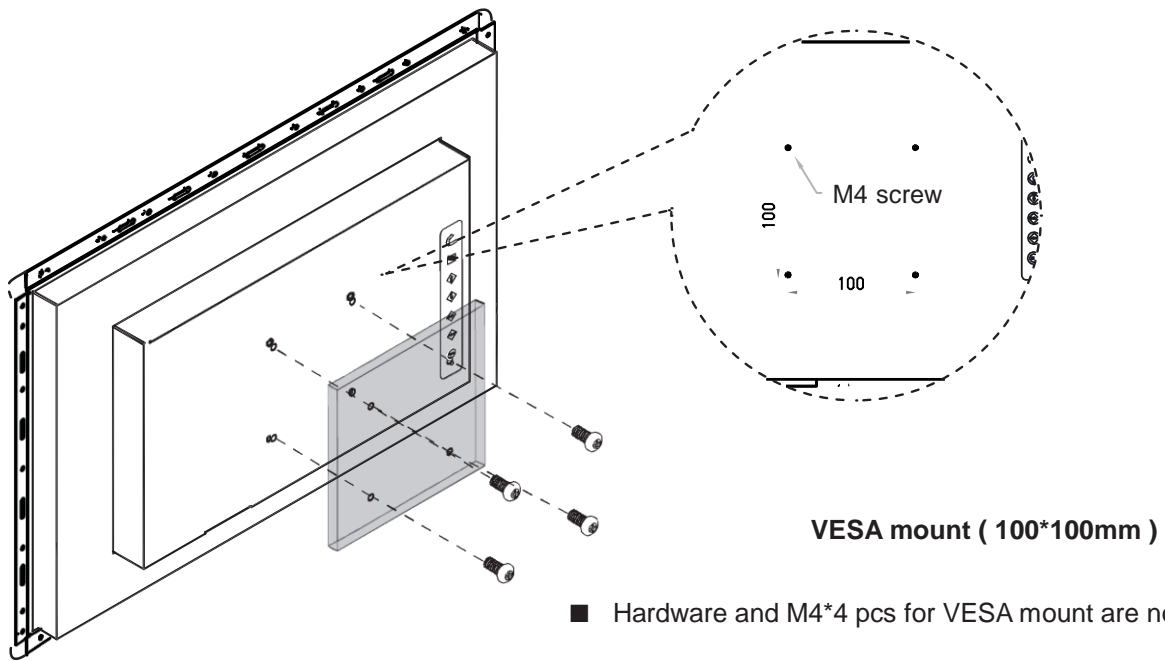

< Part 2 >

< 2.1 > Product Specifications

Mechanical Design	APW5173	
	Front Panel	Black, RAL 9005
	Rear Casing	Black, RAL 9005
	VESA Mounting	100 x 100mm
	Other Mounting	Panel mount
	Protection	3mm protective glass

LCD Panel	Panel Size (diagonal)	17.3-inch Widescreen TFT color LCD
	Display pixel (dots x lines)	1920 x 1080
	Brightness (typ.)	300
	Contrast Ratio (typ.)	600:1
	Color	1.07 Billion, 10-bit
	Viewing Angle (L/R/U/D)	89/89/89/89
	Response Time (ms)	35
	Dot pitch (mm)	0.199
	Display Area (mm)	381.9H x 214.8V
	Surface treatment	Anti-glare, Hard-coating
	Surface hardness	3H
	Backlight Type	LED
	MTBF (hrs)	20,000

Video Connectivity	Digital	HDMI	HDMI 1.1, CEA-861-D
		DVI	DVI-D, TMDS single link
	Analog	VGA	Analog 0.7Vp-p
		Composite (RCA)	NTSC & PAL
		S-Video (4-pin)	NTSC & PAL
	Plug & Play	DVI / VGA	VESA EDID structure 1.3
	Synchronization	VGA	Separate, Composite & SOG

Audio Connectivity	Audio Input	Connector	3.5mm stereo jack
		Impedance / Power level	30k Ω / 750mV
	Audio Output	Connector	3.5mm stereo jack
		Resistance / Power level	30k Ω / 2.8V
	Speaker Output	Power	2 x 2W

*When the audio output is connected, speaker output is OFF

Power	Power Supply	Range	Auto-sensing 100 to 240VAC, 50 / 60Hz
		Power Consumption	Screen display ON
	Power saving mode		4W or less
	Power button OFF		1W or less

Regulatory	Safety	FCC & CE certified
	Environmental	RoHS2 & REACH compliant

Environmental Conditions	Operating	Temperature	0 to 50°C degree
		Humidity	20~90%, non-condensing
	Storage	Temperature	-5 to 60°C degree
		Humidity	5~90%, non-condensing
		Shock	10G acceleration (11ms duration)
		Vibration	5~500Hz 1G RMS random

Physical Specification	Product (W x D x H)	468.5 x 57.1 x 331 mm 18.4 x 2.2 x 13 inch
	Packing (W x D x H)	615 x 113 x 523 mm 24.2 x 4.4 x 20.6 inch
	Net Weight	5.2 kgs / 11.4 lbs
	Gross Weight	8 kgs / 17.6 lbs

Applicable Format	DVI-D / VGA Input	PC Signal	1920 x 1080 x 60Hz
			1360 x 768 x 60Hz
			1280 x 1024 x 60 / 75Hz
			1280 x 960 x 60Hz
			1280 x 768 x 60 / 75Hz
			1152 x 864 x 75Hz
			1024 x 768 x 60 / 70 / 75Hz
			848 x 480 x 60Hz
			800 x 600 x 60 / 72 / 75Hz
			720 x 400 x 70Hz
			640 x 480 x 60 / 72 / 75Hz
			640 x 400 x 70Hz
	640 x 350 x 70Hz		
	HDMI Input	PC Signal	Same as VGA
			Video Signal
		Audio Signal	2ch Linear PCM (32 / 44.1 / 48 KHz)
Composite / S-Video Input		NTSC	525 lines, 60 fields / sec
	PAL	625 lines, 50 fields / sec	

< 2.2 > On-screen Display Operation (OSD)

- Power light
- Green = On
- Orange = Power saving

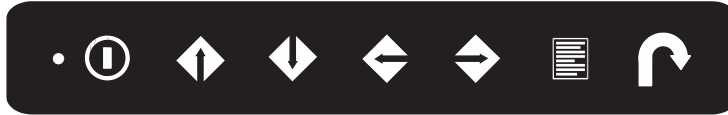

Membrane Switch	Function
	Power on / off LCD
	Display the OSD menu
	Scrolls through menu options and adjusts the displayed control (To auto adjustment by pressing the button for 5 seconds)
	Exit the OSD screen Toggle analog, digital & video connection (DVI-D and video options only)

① Picture

- Picture mode : Standard / Vivid / Soft / User mode to choose
- Brightness : Adjust background black level of the screen image
- Contrast : Adjust the difference between the image background (black level) and the foreground (white level)
- Hue: Adjust the screen hue value
- Saturation : Adjust the saturation of the image color
- Picture size : Adjust the image size
- Color temp : Standard / Cool / Warm / User to choose
- Noise reduce : Reduce the noise of the image
- Sharpness : Adjust the image from weak to sharp

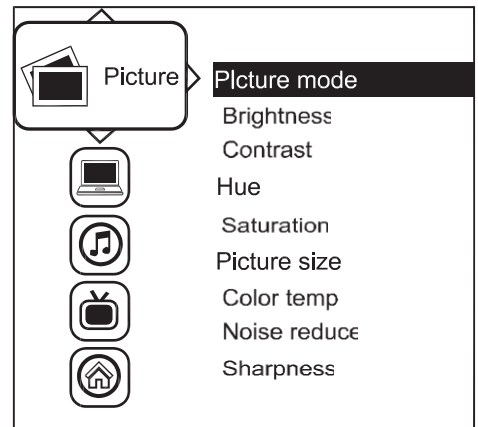

② PC

- Auto adjust : Automatically adjust sizes, centers and fine tunes the video signal to eliminate waviness and distortion.
- Clock : Adjust the clock value
- Phase : Adjust the phase value
- H. Position : Align the screen image left or right
- V. Position : Align the screen image up or down

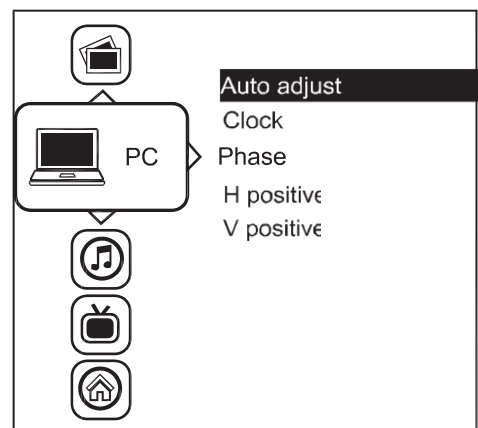

< 2.2 > On-screen Display Operation (OSD)

③ Audio

- Audio mode : Movie / Voice / Normal / Music mode to choose
 Volume : Adjust the volume of sound
 Bass : Set the value of bass sound
 Treble : Set the value of treble sound
 Balance : Set the balance value of treble and bass sound
 Analog TV audio : Set the value of analog TV audio sound
 Mute : Turn off the surrounding sound

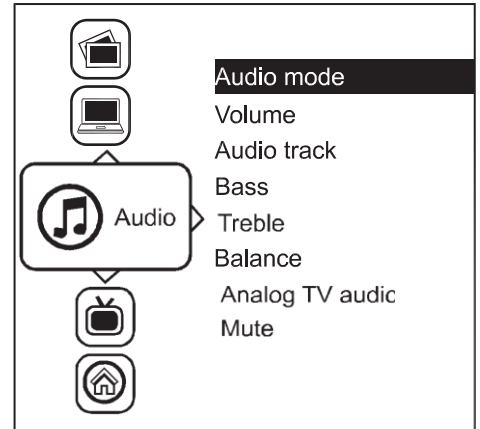

④ TV

- Auto search : Automatically search
 Manual search : Search the TV manual
 Fine tune : Fine tune the TV signal
 Color system : Adjust the TV color
 Sound system : Adjust the TV sound
 Channel edit : Edit the channel

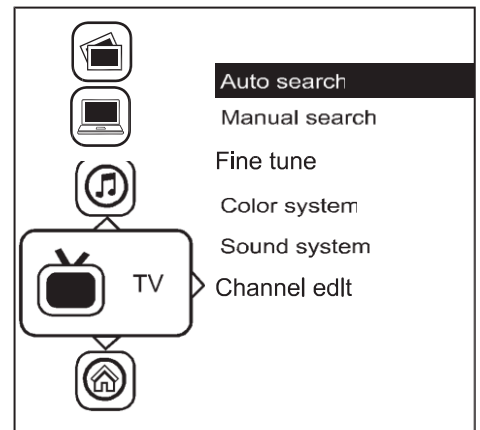

⑤ MISC

- Language : Select the language in which the OSD menu is displayed - English
 Sleep timer : Set the off time
 PIP mode : Adjust picture in picture setting
 PIP position : Enter into PIP position
 PIP source : Enter into the Sub source and sound source
 System reset : Return the adjustment back to factory setting
 Information : Select for Help

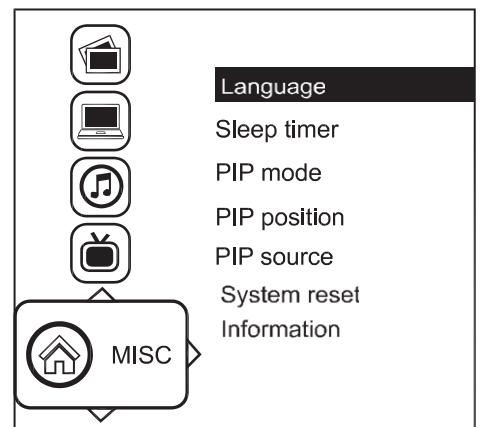

< 2.3 > How to Use Picture In Picture (PIP) / Picture By Picture (PBP)

< 2.3.1 > Picture in Picture (PIP)

Mode

Display the Sub screen in the Main screen.

OSD Menu → MISC → PIP Mode → Large / Small / OFF

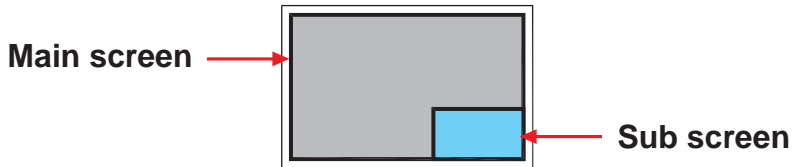

Position

Adjust the position of the Sub screen (top left, bottom left, top right, bottom right)

OSD Menu → MISC → PIP Position → top left / top right / bottom left / bottom right

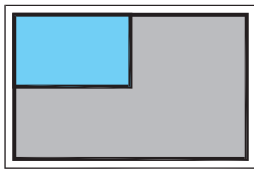

top left

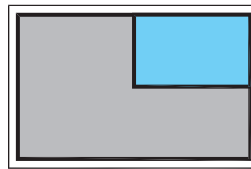

top right

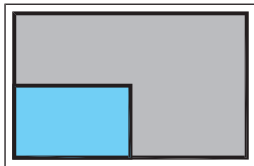

bottom left

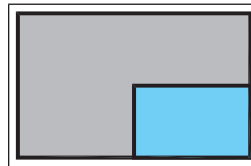

bottom right

Size

Adjust the size of the Sub screen (Large / Small)

OSD Menu → MISC → PIP Mode → Large / Small

Size of Sub screen

LCD Monitor	Large Sub screen	Small Sub screen
1920 x 1200	552 x 414	480 x 360
1920 x 1080	552 x 414	480 x 360
1440 x 900	414 x 310	360 x 270
1366 x 768	392 x 294	340 x 254
1280 x 1024	368 x 276	320 x 240

< 2.3.2 > Picture By Picture (PBP)

Mode

Display the Sub screen next to the Main screen.

OSD Menu → MISC → PIP Mode → PBP



Size

LCD Monitor	Main / Sub screen
1920 x 1200	955 x 716
1920 x 1080	955 x 716
1440 x 900	715 x 536
1366 x 768	678 x 508
1280 x 1024	635 x 476

< 2.3.3 > PIP / PBP Source

To select an input signal for PIP / PBP Sub screen.

OSD Menu → MISC → PIP Source → VGA / S-Video / Composite / DVI / HDMI / SDI / YPbPr / TV

The PIP / PBP is operable in the following table :

Main	Sub	VGA	S-Video	Composite	DVI-D	HDMI	SDI	YPbPr	TV
VGA		X	O	O	O	O	O	O	O
S-Video		O	X	X	O	O	O	O	X
Composite		O	X	X	O	O	O	O	X
DVI		O	O	O	X	X	O	O	O
HDMI		O	O	O	X	X	O	O	O
SDI		O	O	O	O	O	X	X	O
YPbPr		O	O	O	O	O	X	X	O
TV		O	X	X	O	O	O	O	X

< Part 3 > Options

< 3.1 > Option Table

Options	APW
SDI ***	✓
S-Video * + Composite (BNC)	✓
Audio	✓
Touchscreen	✓
MCS multi-display control	✓
DC Power	✓
MIL-type / lockable connector	✓
TV (Analog) *	✓



*** About SDI

The AD board comes standard with HDMI, DVI-D, VGA, S-Video, BNC, audio inputs and RC-1 remote controller.

* Remote Controller

TV option comes with RC-2 remote controller.

< 3.2 > Options : 3G / HD / SD-SDI input



Acnodes' SDI input is an ideal solution for the broadcast-grade video and high resolution CCTV market.

Designed for use with Full HD 1080p and ultra high resolution 1920 x 1200 LCD displays, Acnodes provides a SDI input module without using additional space or power and it comes standard with a 2-year warranty.

SDI

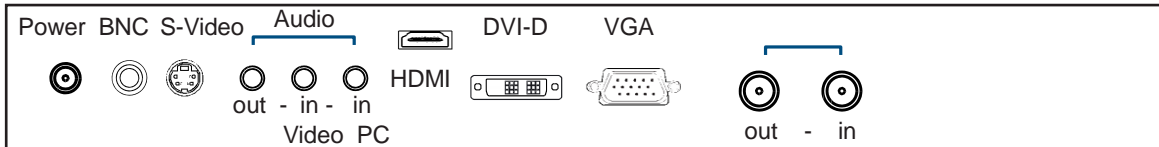

*** For **SDI** option, the AD board comes standard with HDMI, DVI-D, VGA, S-Video, BNC, audio inputs and RC-1 remote controller (please refer to P.17)

INPUT	3G-SDI IN	BNC x 1 / 0.8Vp-p (75 ohm)
	3G-SDI OUT	BNC x 1 / Active through, equalized & relocked

Standard Compliance	Video	SMPTE 425M / 274M / 296M / 125M ITU-R BT.656
	Audio	SMPTE 299M / 272M-C

Compatible Video Format	3G-SDI	1080p @60 / 50Hz, 4:2:2 1080p @30 / 25 / 24Hz, 4:4:4 1080i @60 / 50Hz, 4:4:4 720p @60 / 50Hz, 4:4:4
	HD-SDI	1080p @30 / 25 / 24Hz, 4:2:2 1080i @60 / 50Hz, 4:2:2 720p @60 / 50Hz, 4:2:2
	SD-SDI	480i @60Hz, 4:2:2
	ITU-R BT.656	576i @50Hz, 4:2:2

Compatible Audio Format	3G-SDI	48kHz, 16 / 20 / 24 bit, 2 CH, Synchronized Video
	HD-SDI	48kHz, 16 / 20 / 24 bit, 2 CH, Synchronized Video
	SD-SDI	48kHz, 16 / 20 / 24 bit, 2 CH, Synchronized / Asynchronized Video

Max. Transmission Distance 75 ohm coaxial cable	3G-SDI	150m at 2.97Gb/s
	HD-SDI	250m at 1.485Gb/s
	SD-SDI	480m at 270Mb/s

< 3.3 > Options : MCS

MCS (Multi-display Control)



More control is always good. Especially when it is necessary and easy. Acnodes provides MCS solution to control the **OSD** of various LCD display up to 64 units.

The RS-232C is used for the communication between the PC and the first display via a 15 feet serial cable while the CAN bus is used for the various LCD displays cascade together via CAT 5/6 cable, and daisy chain up to 1,000 meters.

Designed for use with various LCD displays, Acnodes provides a MCS input module without using additional space or power and it comes standard with a 2-year warranty.

MCS

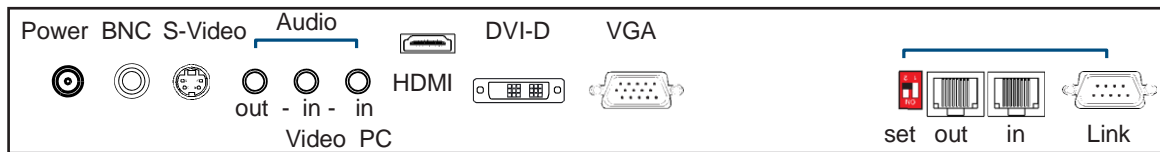

*** Please download the protocol of MCS control at :
<http://www.acnodes.com/files/downloads/MCS-UM.pdf>

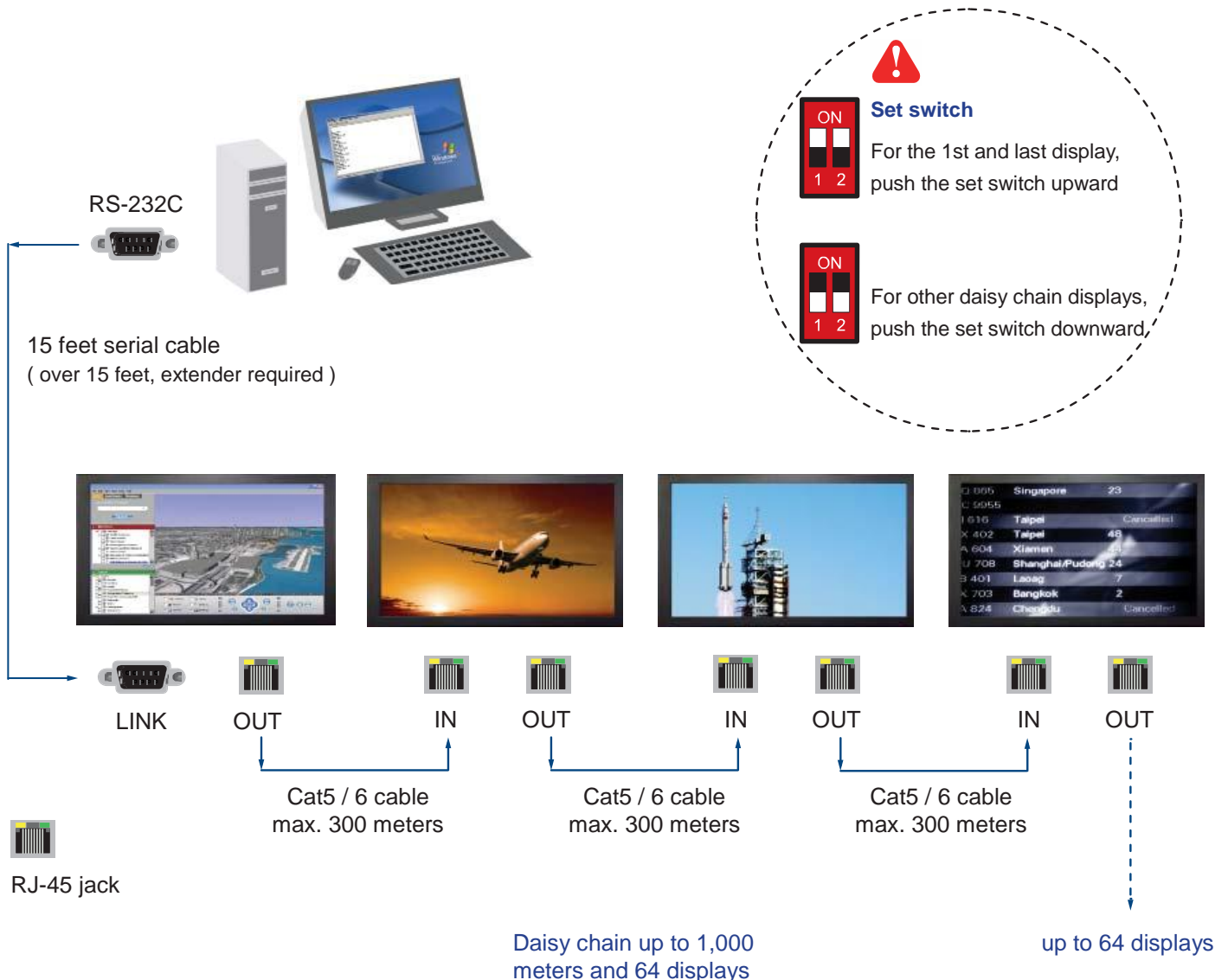

< 3.4 > AV3.0 Upgrade Options :

- **AV** (S-Video + Composite, BNC)
- **Audio** (3.5mm audio jacks for audio in & out, and 2W + 2W speakers)

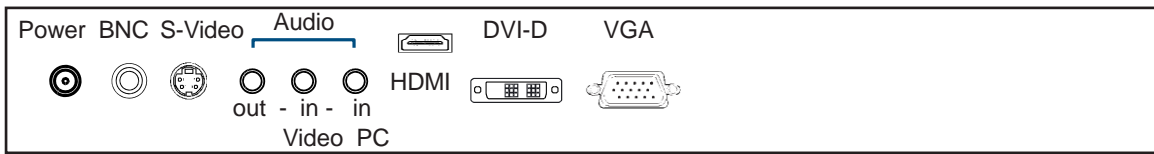

AV3.0 upgrade option comes with RC-1 remote controller x 1, please refer to P.17

How to Use RC-1 Remote Controller

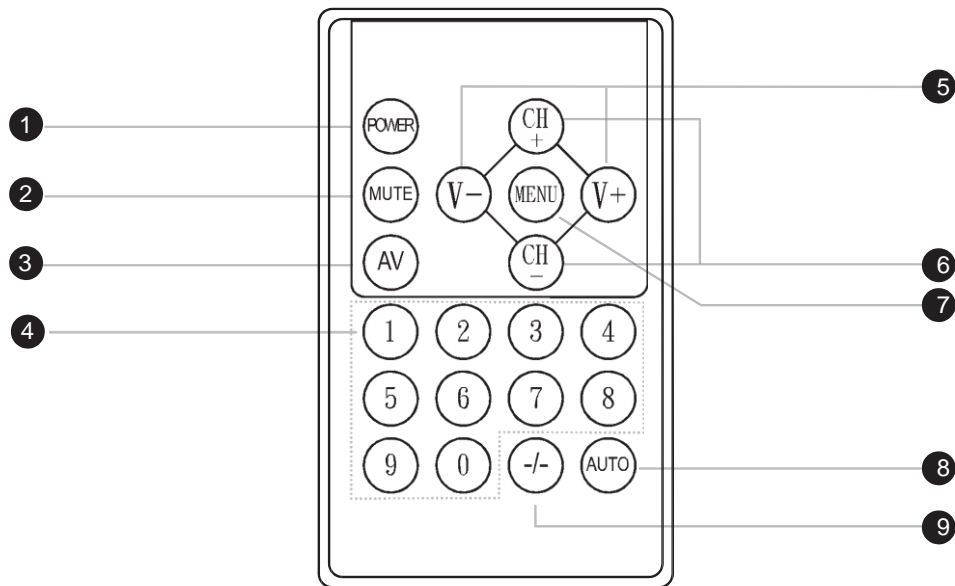

①	POWER	Switches on or off the TV
②	MUTE	Turn on or off the speaker
③	AV	Switch to AV mode
④	0-9	Select channels. For channel numbers 10 and above, enter the second digit within two seconds.
⑤	V +/-	Increase or decrease the speaker volume
⑥	CH +/-	Increase or decrease the channel number
⑦	MENU	Display the menu on the screen or go to the previous menu
⑧	AUTO	For auto searching
⑨	-/-	For setting one or two input digit

< 3.5 > Options : Touchscreen & driver



F17" USB Touchscreen Specification

Model	TRB e-Resistive
Technology	5-Wire Resistive
Touch Point	Single
Input Type	Finger or Stylus
Resolution	2048 x 2048
Touch Point Accuracy	-
Response Speed	15 ms
Activation Force	≤ 50 g
Surface Hardness	3H
Light Transmission	80% ± 3%
Haze	8% ± 3%
Durability Top	10 million touches
Layer Bottom	ITO Film
Layer	ITO Glass
Thickness	2.2 ± 0.2 mm
Connector	USB Type A
Compatibility	Windows 7 / XP / Vista, Linux

- USB touchscreen package includes 1 x 6ft USB cable, quick reference guideline and CD disc
- For detailed information, please refer to the attached CD disc
- As the touchscreen unit is not made of toughened glass, please handle it carefully

USB Touchscreen

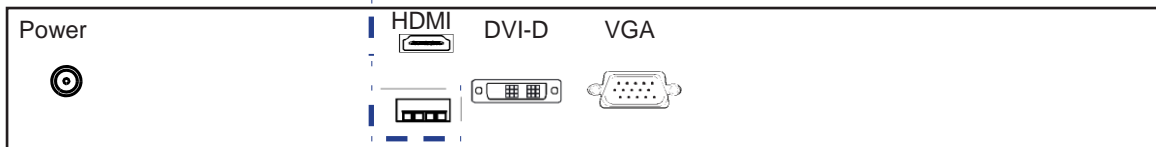

< 3.5 > Options : Touchscreen & driver



TRB Driver

Please follow the below steps to setup the touch screen:-

Step 1. Run the bundled CD disc

Step 2. Double click the Setup.exe

Step 3. Follow the installation instruction to finish the setup

Step 4. After installation, run the TouchKit program & the “4 point calibration”



Please do the initial calibration after the first setup

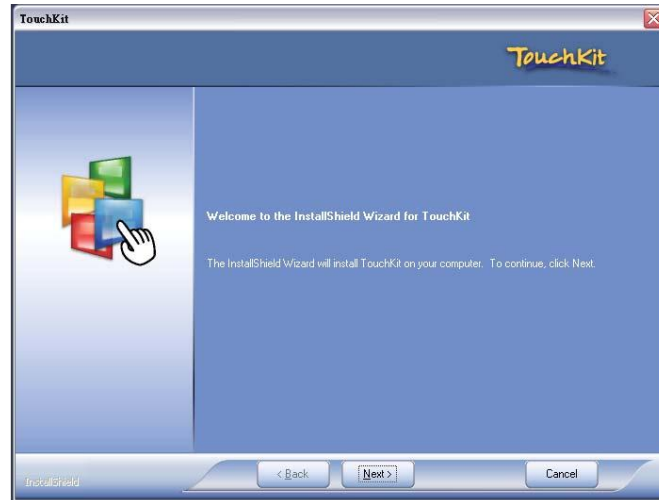

< 3.6 > Options : DC Power

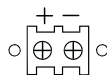



Model	12V	24V	48V
Input rating			
Input voltage:	12-Volt	24-Volt	48-Volt
Input range:	9 ~ 18V	18 ~ 36V	36 ~ 75V
Input current			
- No load	50 mA	50 mA	50 mA
- Full load	4950 mA	2450 mA	1220 mA
Output rating			
Output voltage:	12-Volt	12-Volt	12-Volt
Output current:	4.16A	4.16A	4.16A
Efficiency	84%	85%	85%

< 3.7 > Options : MIL-type or Lockable Connector

	Input	Part no.	MIL Standard
MIL - type Connector	DC Power *** (Male)	MS3470W8-33P 	MIL - DTL - 26482
	VGA *** (Male)	MS3470W14-15P 	MIL - DTL - 26482

*** There are several additional MIL DC and VGA connector types with varying design characteristics to meet cost considerations and to provide users with the most design flexibility possible. For more information, please contact us.

	Input	Part no.	Standard
Lockable Connector	DC Power (Male)	YM-Ext-461CP001 	D-type 3W3
	USB	LUSB - A111 - 00 	-

*** MIL - type or Lockable connectors above can be integrated with our LCD displays. Sale service just for connectors not provided.

< 3.8 > Options : TV (Analog)

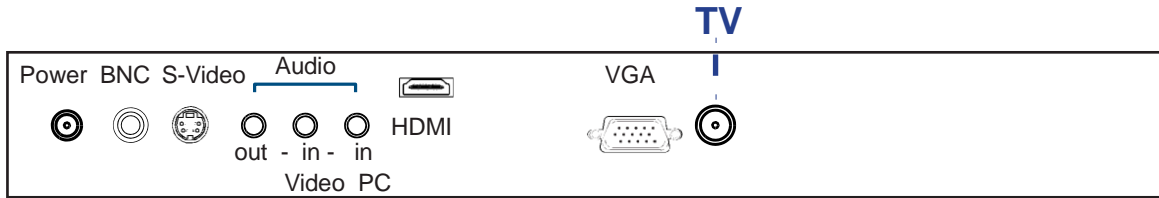

*** For TV option :

- (1) The AD board comes standard with HDMI, VGA, S-Video, BNC, audio inputs and RC-2 remote controller.
- (2) Casing dimensions will be changed.

How to Use RC-2 Remote Controller

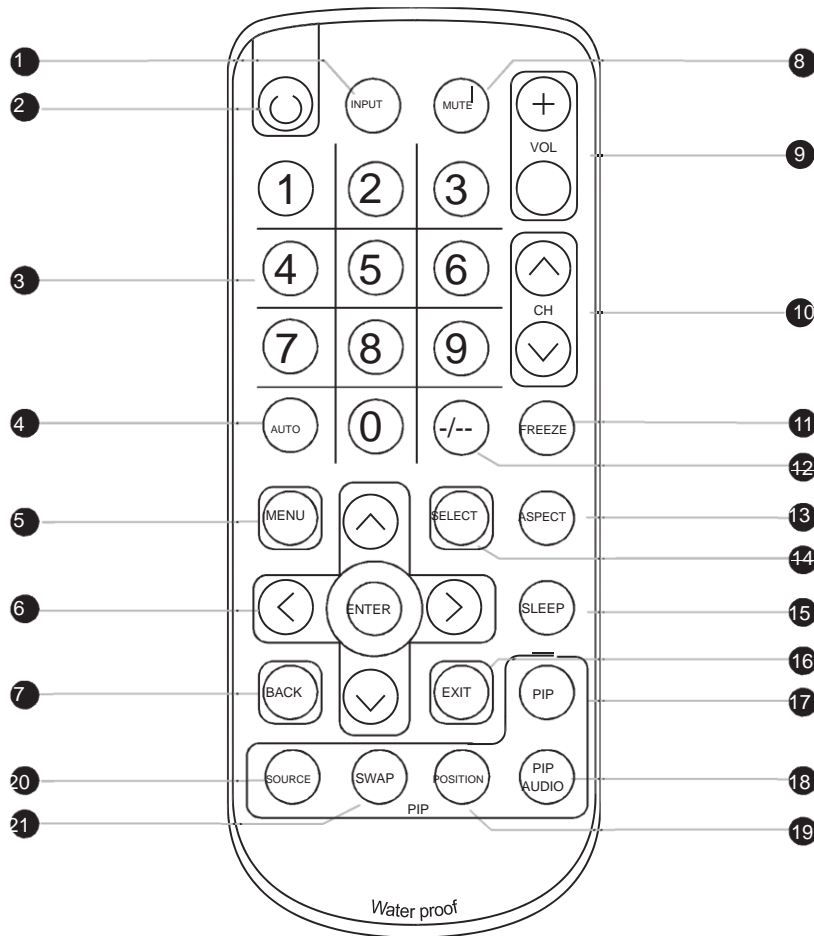

①	INPUT	Select the source
②		Switches on or off the TV
③	0 - 9	Only use in TV mode. Select channels. For channel numbers 10 and above, enter the second digit within two seconds.
④	AUTO	Auto adjust
⑤	MENU	Display the menu on the screen or go to the previous menu
⑥	ENTER	Go to the upper menu or select the previous value / Go to the next menu or select the next value / Decrease the setting value / Increase the setting value or enter to the select item setting Enter to the select item settings or excude the setting
⑦	BACK	Back to previous value
⑧	MUTE	Turn on or off the speaker
⑨	Vol + / -	Increase or decrease the speaker volume
⑩	CH + / -	For TV model only, increase or decrease the channel number
⑪	FREEZE	Reserve for OEM model
⑫	- / --	For setting input single or double digits
⑬	ASPECT	Adjust the screen size
⑭	SELECT	To select the existing item
⑮	SLEEP	Select the sleeping time
⑯	EXIT	Exit the menu or cancel
PIP functions		
⑰	PIP	Picture in picture
⑱	PIP AUDIO	To set the audio of in PIP mode
⑲	POSITION	To set the screen position in PIP mode
⑳	SOURCE	PIP Source
㉑	SWAP	Swap screen in PIP mode

