

ADPRO PRO Series

Passive Infrared Perimeter Intrusion Detector

Preliminary Data Sheet



The complete new portfolio of ADPRO PRO E-PIR Perimeter Intrusion Detectors (PID) were engineered to provide extraordinary reliability and accuracy. This new generation of PIRs evolved from the Xtralis defense-grade perimeter protection technology and our proven series of ADPRO PRO PIRs.

Utilising Passive Infrared (PIR) technology and combining it with precision mirror optics, employing the latest digital signal processing (DSP) and an environmental adaptive circuitry - this provides the exceptional reliability of detection while minimising nuisance alarms.

ADPRO PRO E-Series detectors achieve unsurpassed performance even under precarious environmental conditions. The ADPRO PRO E-Series PIR detectors are available in a variety of models to optimally address your perimeter, performance, and budget needs.

PRO E-Series - Extraordinary Features

Complete New Housing Design

- Designed for wall and pole mounting - no additional adaptors required
- Integrated cable management - no visible cable routing directly from mounting surface
- Designed for one-man installation with the iCommission tool which allows for wireless control of the PIR detectors via the iCommission application installed on a smartphone or tablet PC
- Simple on-site exchange of the filter module (window) - no detector factory overhaul
- Sophisticated 3D-tamper (pan/tilt/move) protection including a compass (slow panning)
- Detection of attempted removal from mounting surfaces also includes cable managed bracket
- Prepared for further enhancements and options - such as IP connectivity, wireless communication or even battery operation (in combination with renewable energy sources)

“360PROtect™” Technology - Near Surrounding Area Surveillance

- Special tamper protection of the detector - eliminating creep zones
- Creep zone surveillance starts 1m behind the detector (back sight)

Detector Masking

- Manipulation, vandalism, and/or tampering of the detector’s input capability with objects such as metal, plastics, paper or sprayed paints or lacquers in close proximity to the detector are detected and indicated as required by upcoming IEC- and EN-standards for perimeter detectors

Quick Setup

- No hardware programming via DIP-switches – just select the appropriate detector and turn the rotary switch to the right position and all default settings are done
- Via standard RS-485-communication all parameters can be adapted

Product Highlights

PRO E-Series detectors deliver exceptional savings of time and total cost of ownership.

- Designed to be compliant to prEN 50606 Grade 3
- IP65-rated housing for all models
- iCommission enabled for one man commissioning and installation
- Integrated Cable Management Invisible cable routing for tamper protection
- Remote configuration and alarm management via RS485-communication
- Auto-sensing supply voltage 10.5-30 V_{DC} and 24 V_{AC}
- Low power consumption - ideal for wireless and solar applications

Providing maximum tamper protection

- “360PROtect™” Technology - near surrounding area surveillance, as a special tamper protection of the detector - from 1 m behind the pole/ wall up to 8m - eliminates all creep zones
- Detects attempted removal from mounting surface
- Advanced 3D-tamper detection signals an alarm if detector alignment is altered, in addition to traditional housing cover switch
- Detector masking detection
- Up to 4 m (13 ft) mounting height to minimise the risk of vandalism

Highest reliability of detection — minimising nuisance alarms

- Directional discrimination for additional 60% nuisance alarm reduction (De-models only), allowing for right-to-left or left-to-right intrusion alarms only
- Heater and heavy-duty silicon wafer front window for -40° to +60° C (-40° to 140°F) operating temperature, ideal for extreme environments (standard for H-models)
- Detection of intruders crawling, walking or running at speeds from 0.2 to 5 m/s (0.7 to 16 ft/s)
- Ultra-low nuisance alarm rate thanks to advanced digital signal processing (DSP), and adaptive threshold discrimination
- Low cost per unit of coverage cutting edge and manufactured precision engineering results in a highly reliable, cost efficient product

Accessories

- iCommission - One-Man-Commissioning-Tool including iCommission-App for remote controlled tilt adjustment
- PRO E-Tool - configuration, commissioning, analysis and remote control software
- IFM-485-ST - PC interface module including PRO-E-Tool software for PC-based installation, commissioning, maintenance and alarm management of all PRO detectors
- CT PRO 2 - wireless walk-tester (2.4 GHz) for all PRO detectors
- AD 851 - alignment telescope for all models

360PROtect™ - Near Surrounding Area Surveillance

This Xtralis technology provides special tamper protection for all ADPRO PRO E-detectors. This innovation provides protection from 1 m behind the pole/wall installation up to 8 m - completely eliminating all creep zones. Cost savings and superior protection are realized with one ADPRO PRO E-detector; creep zones are eliminated and the areas behind and aside the detector are monitored.

Regarding tamper security 360PROtect™ technology puts ADPRO PRO E-detectors unambiguous on leading position.

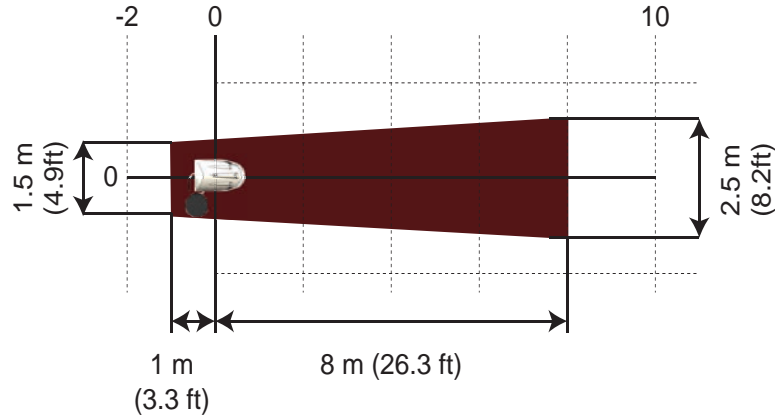

ADPRO PRO E-Wireless Detectors - powered by Inovonics EchoStream®

Based on same technical specifications as wired models, Xtralis offers a supplemental range of wireless ADPRO PRO-E detectors with Inovonics' built-in RF module EN1941:

**PRO E-18WRFe, PRO E-18WRFn,
PRO E-45RFe, PRO E-45RFn,
PRO E-100RFe, PRO E-100Rfn**

[-RFe = 868 MHz (EU) / -RFn = 911 MHz (USA)]

These detectors transmit alarms and fault messages one way wireless to an Inovonics receiver e.g. EE4232MR/EN4232MR or EE4216MR/EN4216MR.

The Inovonics Commercial Mesh Network has been specifically developed for commercial applications to provide the most cost-effective solution for a wide range of applications, while setting new standards for performance and reliability in a wireless sensor network.

Reliability

Inovonics EchoStream 868/900MHz radio utilizes a unique frequency hopping, spread spectrum technology to meet the demands of an increasingly cluttered wireless world.

Flexibility

The flexibility of wireless is a necessity in today's dynamic commercial environments. The self-configuring EchoStream Commercial Mesh Network allows you to adapt to changing floor plans and requirements in a matter of minutes. New sensors can be added to the network as fast as they can be mounted.

Scalability

The EchoStream Commercial Mesh Network's backbone of intelligent repeaters EE5000/EN5000 can extend coverage to thousands of sensors across entire commercial campuses.

Battery-Life-Time of 2-years

Under normal conditions a battery-life-time of 2 years is achievable, this is dependent on structure and environmental conditions of operation, number of events and other site-specific influences.

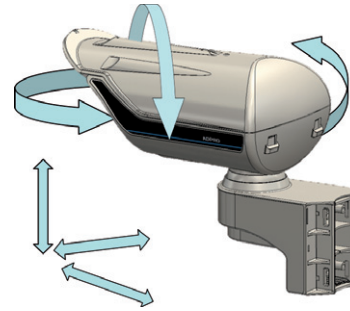

Sophisticated Tamper Protection

All ADPRO PRO E-detectors monitor:

- opening of detector housing and mounting bracket cover
- horizontal, vertical and pitch alignment
- slow horizontal movements with the help of an integrated switchable digital compass
- removal from mounting surface

These features fulfill the highest tamper protection requirements and ensure reliable operation in the highest graded security applications.

ADPRO PRO-E Detector Outputs

All ADPRO PRO E-detectors have 3 free programmable outputs for alarms from:

- PIR-sensor, 360PROtect™ or masking detection
- fault events caused by the power supply, exceeded temperatures, faulty heating device, masking detection or watch-dog
- tamper alarms of housing cover, cable managed bracket cover, misalignment and removal from mounting surface attempts

All high-performance detectors (H-versions) offer additionally two independent outputs for alarms from:

- 360PROtect™, masking or alarm zone or other events

For plug & use, all outputs are set to standard compliant default settings, which can be changed easily with the ADPRO PRO E-Tool software.

Applications

- Outdoor perimeter and area detection:
 - solar fields
 - pipelines
 - logistic centers
 - scrap merchants
 - warehouses
- Fence-line protection
- Anticipating and proactive video surveillance
- Providing reliable detection for remotely monitored and detector activated CCTV systems for maximum Central Monitoring Station profitability
- Conditional triggering of CCTV, PTZ and dome cameras
- Conditional triggering of video-switchers for event-driven CCTV

Recommended Ranges and Positioning

ADPRO PRO E-series detectors offer the best value per foot of coverage when compared to similar effective intrusion detection technologies. ADPRO has pushed the limits of the PIR technology to new frontiers, thus making it the ideal choice for cost conscious decision makers unwilling to compromise on security. Longer perimeters are easily divided into sections not exceeding the nominal range of the chosen detectors. The PRO E-detectors are designed to provide gap-free coverage in, around and behind the mounting location.

Mounting

Recommended mounting height is 2.5 – 4 m (8 – 13ft). All PRO E-detectors are ready-to-use on walls or poles without any adaptors and have an integrated tamper-monitored cable managed bracket.

iCommission™

All detectors can be vertically aligned with a smartphone or tablet PC e.g. during walk-test remotely with the optional use of iCommission. With the help of iCommission one engineer can mount, align, and fine-adjust a detector - one man commissioning for noticeable cost and time savings.



Remote Service

All detectors are equipped with a two-way data port. Using the ADPRO PRO E-Tool software via the IFM-485-ST interface, configuration details and live signals, as seen by the detectors, can be changed and reviewed remotely.

The IFM-485-ST interface module and the ADPRO PRO E-software are very helpful during both the installation process, but also during operation later on. For example, detector configuration changes can be applied in real time without climbing any ladders.

System Design Considerations

It is considered good design practise to terminate a detector's field of view with a barrier if the PIR field of view exceeds the desired detection zone, especially if it borders onto unknown or busy terrain. Wire mesh fence alone will not work, a closed surface area is necessary, wood or plastic materials are perfectly suitable.

For more details and a professional system design we strongly recommend to refer to the "Planning and Commissioning Manual" on:

www.xtralis.com/ADPRO_PRO_E_Detectors



Technical Specifications — Preliminary

Specification / Model	PRO E-18	PRO E-18H	PRO E-18W	PRO E-18WH	PRO E-30	PRO E-40	PRO E-45	PRO E-45H	PRO E-45D	PRO E-45DH	PRO E-51	PRO E-85	PRO E-85H	PRO E-100	PRO E-100H
Item Code	CH10055001	CH10055101	CH10053001	CH10053101	CH10063001	CH10073001	CH10023001	CH10023101	CH10023201	CH10023301	CH10083001	CH10043001	CH10043101	CH10033001	CH10033101
Detection principle	Volumetric medium-range		Volumetric wide-angle		Volumetric medium-range	Volumetric medium-range	Curtain, medium-range	Curtain, directional, medium-range		Volumetric, long-range			Curtain, long-range		
Nominal range (L x W), width at nominal range	24 m x 21 m (80 ft x 70 ft)	30 m x 27 m (100 ft x 90 ft)	21 m x 24 m (70 ft x 80 ft)	27 m x 30 m (90 ft x 100 ft)	30 m x 20 m (100 ft x 65 ft)	40 m x 10 m (130 ft x 33 ft)	50 m x 3.3 m (165 ft x 11 ft)	60 m x 3.9 m (200 ft x 13 ft)	50 m x 3.6 m (165 ft x 12 ft)	60 m x 4.2 m (200 ft x 14 ft)	50 m x 22 m (165 ft x 72 ft)	60 m x 18 m (200 ft x 60 ft)	75 m x 23 m (250 ft x 75 ft)	120 m x 2.9 m (400 ft x 9 ft)	150 m x 3.3 m (500 ft x 11 ft)
Angle of beam (angle of aperture, AA)	50°		90°		50°	15°	3.8°	3.8°	4°		26°	17°			1.3°
360PROtect™ - Near Surrounding Area Surveillance	-1 m up to +8 m (-3 ft up to +26 ft)														
Spectral response	8-14μ, double filtered														
Filter (Front Window)	Standard versions: HDPE-Filter, IR transmissive / H-Versions: Silicon Wafer														
Pyroelectric Sensor (differential)	single-channel					dual-channel					six-channel			triple-channel	
Detection speed range	0.2 - 5 m/s (0.7 - 16 ft/s)														
Alarm output (free programmable)	1x Alarm = IR-Alarm, 360PROtect™-alarm, masking														
Fault output (free programmable)	1x Fault = power supply, temperature, heating, masking, watch-dog,														
Tamper output (free programm.)	1x tamper = housing cover, alignment, CMB cover, removal from mounting surface														
Free programmable output (360PROtect™, masking, zone alarm or other events)	2x 360PROtect™ or masking or zone alarm or other events														
Alarm indicator	Internal LED														
Data-Interface	RS-485, 9600 baud/s // on-board														
Default Settings - Sensitivity	40%, 75%, 100% (% of standard)										n.a.				
- Range	n.a.										30/40/50 m	30/45/60 m	40/60/75 m	60/84/120 m	75/105/150 m
Adjustments via Tool-Software - Sensitivity	20% -140% (% of standard)										Sensitivity 50–150 (% of standard)				
- Range	n.a.										30/40/50 m	30/45/60 m	40/60/75 m	60/72/84/96/108/120 m	75/90/105/120/135/150 m
Cable feed (diameter)	2 x 4-7 mm (0.16" - 0.27")														
Cable termination	Removable screw terminals 0.34 mm ² to 1,5 mm ² (AWG 28 -16)														
Supply voltage	10.5 - 30 V _{DC} , 24 V _{AC} ±15% auto-sensing, excluding heater														
Supply current	approx. 18 mA @ 12 V _{DC} , 12 mA @ 24 V _{DC} , 30mA @ 24 V _{AC} (@ +25°C)														
Outout load (max.)	Solid State Relais 75 mA max. @ 60 V _{DC}														
Heater power (H-versions only)	approx. 2 W / 176 mA @ 12 V _{DC} at -40°C (40°F)														
Operating temperature and temperature compensation	HDPE-filter versions without heater: -20 °C to +60 °C (-4 °F to +140 °F)					// Silicon Wafer versions with heater: -40 °C to +60 °C (-40 °F to +140 °F)					// Full compensation over entire operating temperature range				
Housing material	Luran® S (ASA)														
IP-Rate	IP 65														
Environmental classification	Designed to fulfill EN50131-1 / IEC 62642-1:2010 ¹ Environmental Classification (Class IV - Outdoor)										¹ Scope of EN 50131-/ IEC 62642-standards are for indoor I&HAS only - not for outdoor perimeter detection!				
Mounting	Wall and pole mounting — cable managed bracket (CMB) included														
Weight	approx. 980 g (2.1 lbs), incl. cable managed bracket														
Dimensions (L x W x H)	358 mm x 188 mm x 290 mm (14.1" x 7.4" x 11.4")														
Country of Origin	Designed in Switzerland // Made in China														
CE (incl. RoHS II, REACH, WEEE)	All ADPRO PRO E-Series products fulfill EU-Directive 2011/65/EU (RoHS II), EC 1907/2006+2011 (REACH), EU-Directive 2002/96/EG (WEEE) or do not fall under the scope of these directives.														
HTS-Harmonised Tariff Schedule	8531 9095														
ECCN-Export Control Classif. Number	EAR-99														
Security Grading	Designed to fulfill EN50131-1 / IEC 62642-1:2010 ¹ Security Grades 1-4 (Grade 4 in combination with ADPRO					FastTrace/IntrutionTrace, only)					¹ Scope of EN50131-x-/ IEC 62642- standard are for indoor I&HAS only - not for outdoor perimeter detection!				
Perimeter Detection Standards	Designed to fulfill upcoming European prEN50606-x and IEC standards (in preparation - not published)														
Other Standards & Regulations	British Standards: designed to fulfill BS 8418:2010					VdS: Designed to fulfill VdS 3143 (PIR), VdS3456 and VdS classes B and C (Class C in combination with ADPRO FastTrace/IntrutionTrace, only)									

Detector Overview

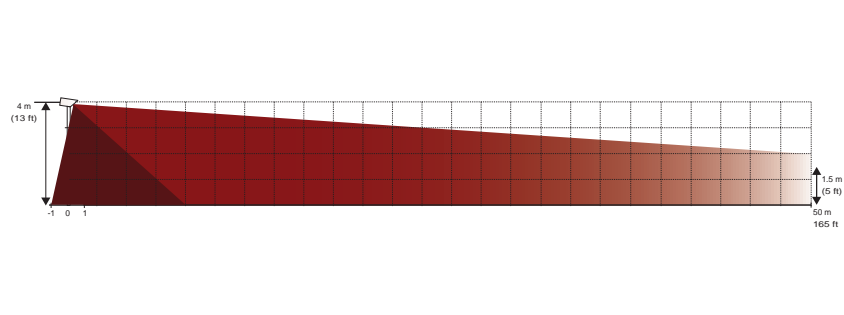
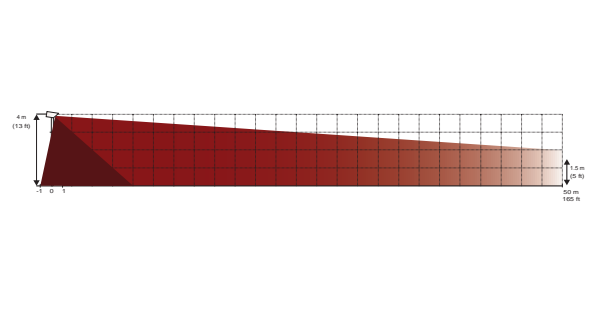
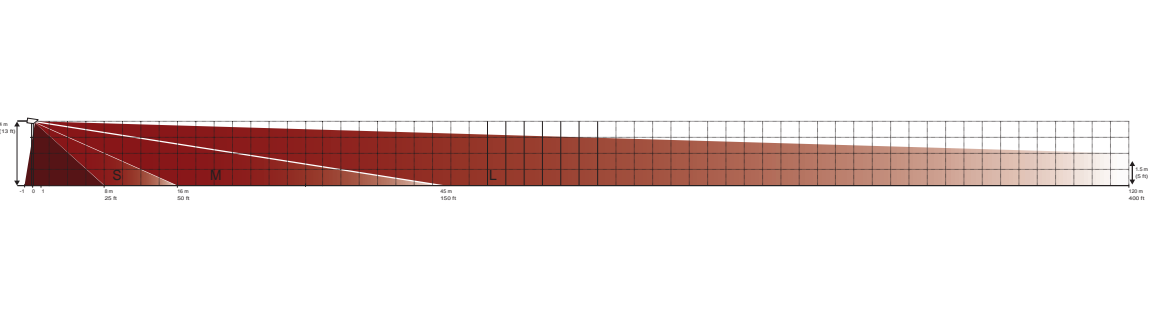
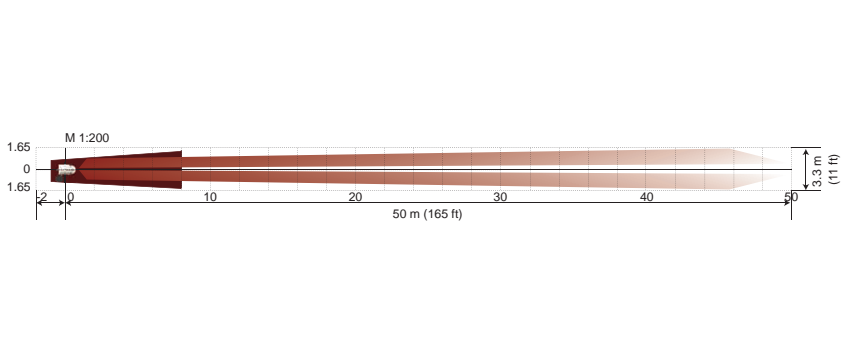
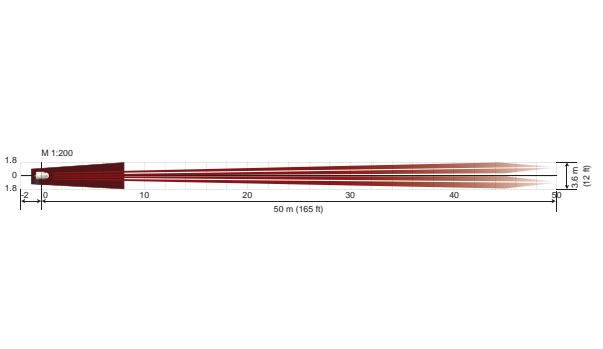
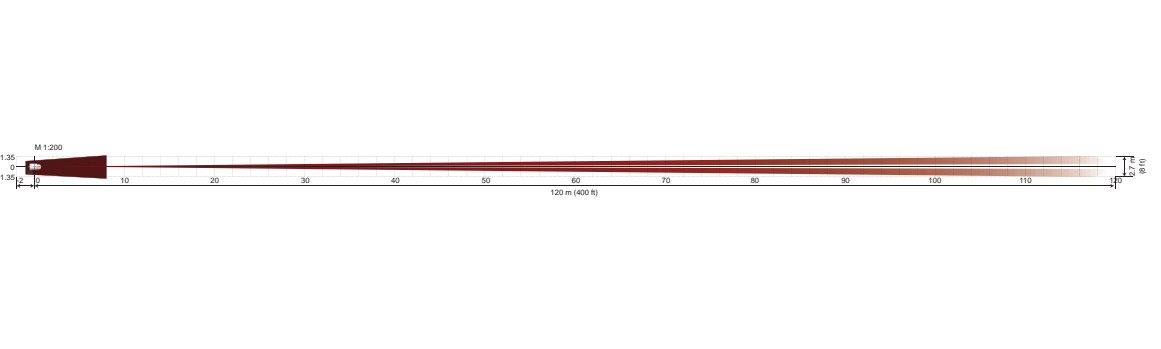
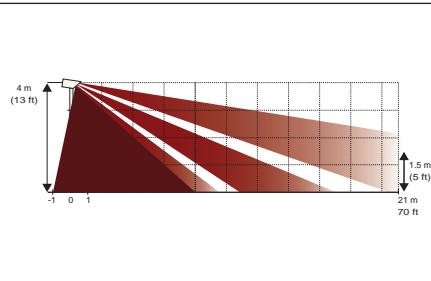
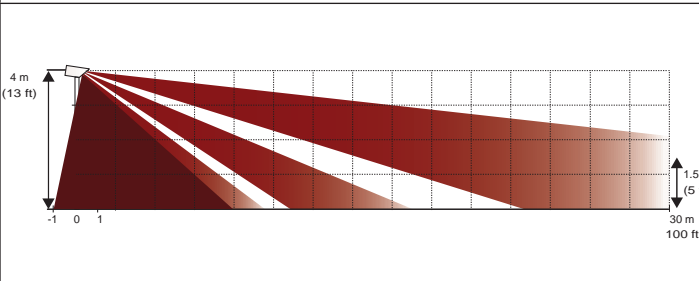
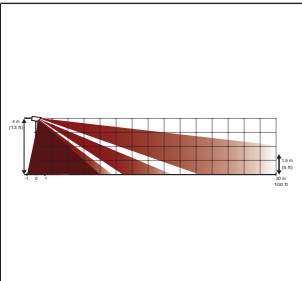
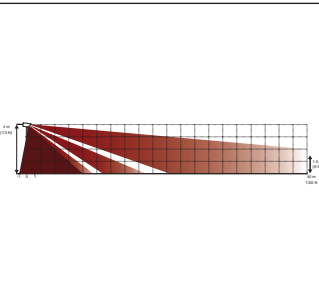
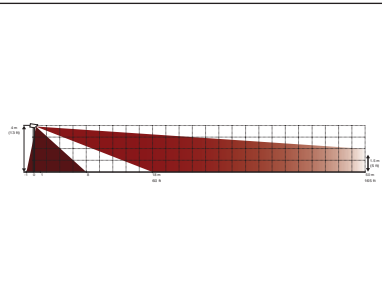
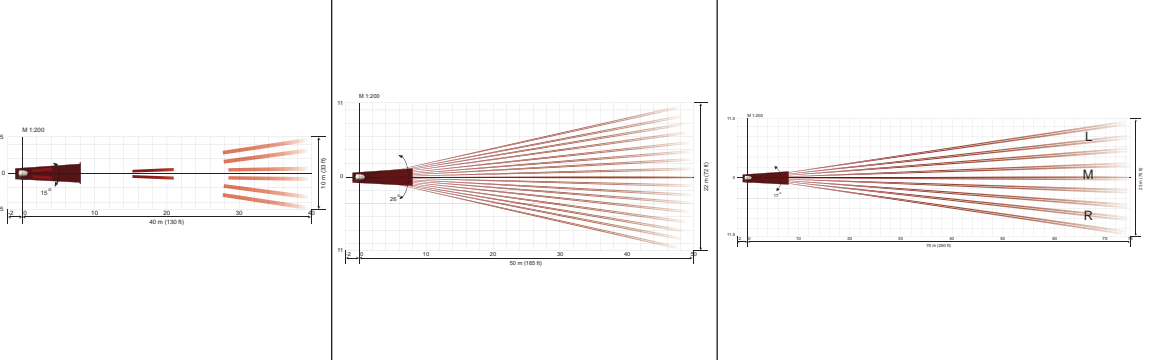
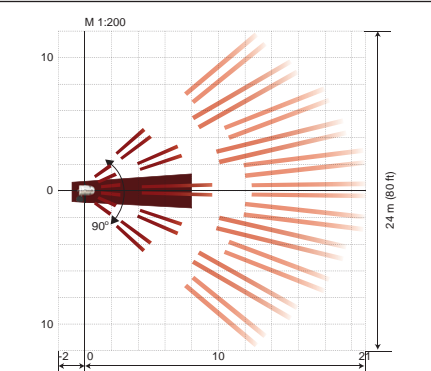
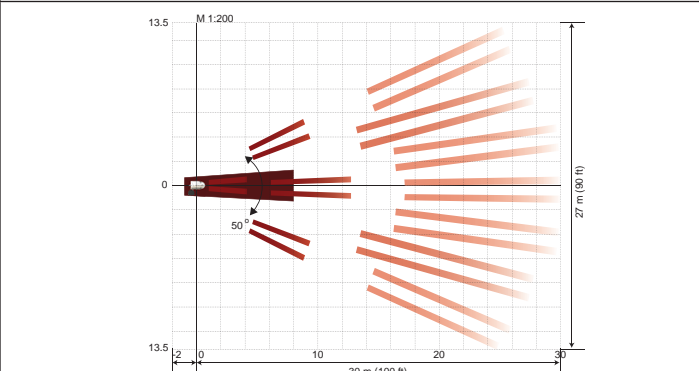
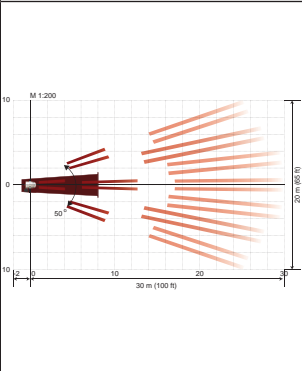
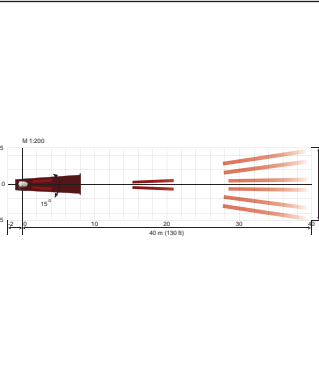
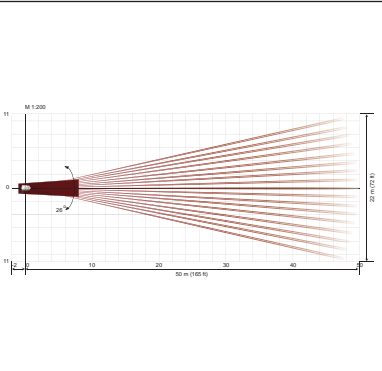
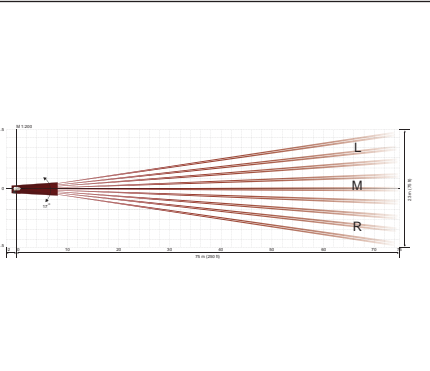
Curtain Models	Medium-range curtain		Directional medium-range curtain		Long-range curtain				
Detector	PRO E-45	PRO E-45H	PRO E-45D	PRO E-45DH	PRO E-100	PRO E-100H			
Coverage L x W (H-Version)	50 m x 3.3 m (165 ft x 11 ft)	60 m x 3.9 m (200 ft x 13 ft)	50 m x 3.6 m (165 ft x 12 ft)	60 m x 4.2 m (200 ft x 14 ft)	120 m x 2.7 m (400 ft x 9 ft)	150 m x 3.3 m (500 ft x 11 ft)			
Optics	Segmented Precision Mirror		Segmented Precision Mirror		Precision Glass Mirror				
Side View Standard Version (H-Version)									
Top View, Width at Nominal Range Standard Version (H-Version)									
Volume Models	Volumetric Wide-Angle		Volumetric Medium-Range			Volumetric Long-Range			
Detector	PRO E-18W	PRO E-18WH	PRO E-18	PRO E-18H	PRO E-30	PRO E-40	PRO E-51	PRO E-85	PRO E-85H
Coverage L x W (H-Version)	21 m x 24 m (70 ft x 80 ft)	27 m x 30 m (90 ft x 100 ft)	24 m x 21 m (80 ft x 70 ft)	30 m x 27 m (100 ft x 90 ft)	30 m x 20 m (100 ft x 65 ft)	40 m x 10 m (130 ft x 33 ft)	50 m x 22 m (165 ft x 75 ft)	60 m x 18 m (200 ft x 60 ft)	75 m x 23 m (250 ft x 75 ft)
Optics	Segmented Precision Mirror		Segmented Precision Mirror			Precision Glass Mirror			
Side View Standard Version (H-Version)									
Top View, Width at Nominal Range Standard Version (H-Version)									

Benefits and Value Propositions

Intrusion detection - an “electronic fence” - in combination with alarm verification - video surveillance - protects property and prevents sabotage. Technologies from Xtralis anticipate disasters by giving users time to respond before life, critical infrastructures or business continuity is compromised.

- **“360PROtect™”**: Near Surrounding Area Surveillance for earliest detection of sabotage attempts and elimination of creep zones. 360PROtect™ results in less detectors, less poles and thus **lowest total cost of ownership (TCO)**
- **“Detector Masking Detection”**: Efficient means to detect attempts to defeat the detector by manipulating (masking) with material impermeable to infrared energy, such as paper, tape, film, or spray, typically during normal business hours when the security system is disarmed. **“CMB Integrated”**: The integrated cable managed bracket (CMB) allows completely hidden cable routing and makes tamper attacks very difficult
- **“PA Integrated”**: The completely new PRO E-detector housing is designed to be mounted directly onto a wall or a pole - no pole adaptors (PA) needed resulting in less installation cost
- **“Best-in-Class by FAR”**: Delivers the lowest nuisance alarm rates, thus best alarm rate
- **Remote access** for configuration and management (via RS-485 databus) even over IP
- **“Compass Inside”**: An integrated switchable compass enhances the 3D-anti-vandal feature to detect alignment changes
- **4 metre (13 ft) mounting height** for minimal risk of vandalism
- **Wide power supply range** 10.5 to 30 V_{DC} or 24 V_{AC} (auto-sensing)
- **Easy on-site enhancement** of all none-H-types with a silicon wafer filter module
- All H-models have an **internal heater with temperature compensation** to prevent condensation on internal components
- No need for separate transmitter and receiver units - PIR-technology allows for single-ended operation for lower installation cost
- **Low installation and maintenance cost**

Advanced Passive Infrared Detection Technology

After 25 years of positive results in favor of durable performance and longevity in harsh environments from PIR outdoor detector technology, it is now widely accepted to be well suited for perimeter protection in harsh environments.

- The area protected by the detector cannot be identified by an intruder due to the passive nature of the unit
- It's easily adaptable for small single detector installations up to large, high security multi-detector applications

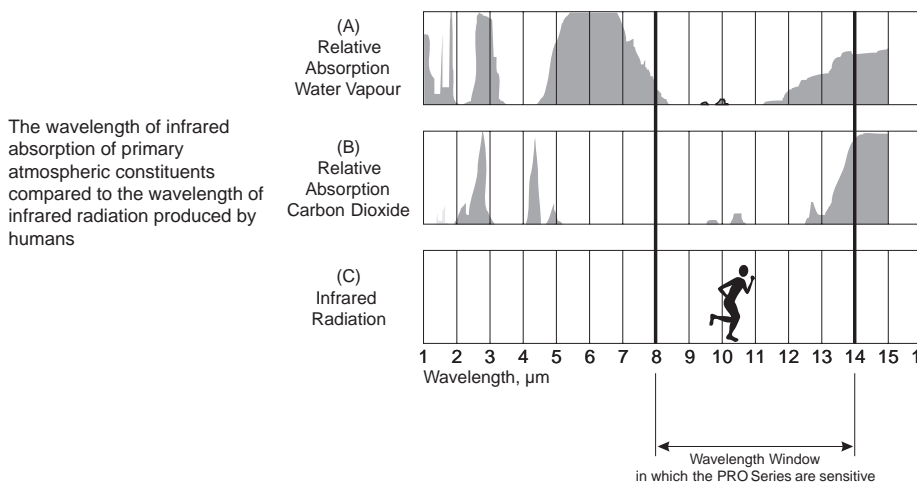

Xtralis Security Solutions Overview

Xtralis offers a powerful portfolio of perimeter, multi-site and enterprise security solutions that lead the industry in reliability and value. ADPRO by Xtralis technologies deliver unparalleled situational awareness from the edge of your facility to its very core, transforming your security program from reactive monitoring to proactive threat detection.

- Intrusion Detection and Perimeter Security
- Video Recording, Transmission and Storage
- Remote Monitoring/Central Monitoring Stations
- Access Control
- Enterprise Security
- Traffic Detection
- Mobile Security Solutions