

# evluma

AreaMax™

available with  
**ConnectLED™**



2014

evluma

## AREAMAX™

The AreaMax is the Utility Standard in LED area and security lighting. The AreaMax introduces a revolutionary new way to deliver dusk-till-dawn efficiency by reducing your dependence on the traditional photocontrol. Affordable and easy to install, the AreaMax slides onto the existing pole arm typically used by NEMA Type V dusk-till-dawn fixtures. As high as 93 lm/W for the entire system, the AreaMax is a recommended LED replacement for the average 100-200W HID fixture. Order the AreaMax with ConnectLED and take advantage of additional maintenance and energy savings with dimming features and remote commissioning/decommissioning.

## Photocontrol Failsafe Mode™

The AreaMax introduces a revolutionary new way to deliver dusk-till-dawn efficiency with a built-in Photocontrol Failsafe Mode. Compatible with NEMA standard twist-lock photocontrols, place the AreaMax in the field with a photocontrol installed. Over time, an internal processor will calibrate the AreaMax to its unique geographic times for sunrise and sunset. Should the photocontrol fail, the AreaMax will take over based on the information it has collected eliminating a maintenance visit and guaranteeing continuous operation. The AreaMax is compatible with low cost, affordable photocontrols. No need for expensive 'LED' specific photocontrols, often a hidden cost when it comes to other fixtures.

## ConnectLED™

ConnectLED is a software application that communicates with the AreaMax via BLE (Bluetooth Low Energy) to:

- commission /decommission the fixture
- create brightness settings
- upload custom dimming algorithms
- read FaultCast™ status transmissions
- activate motion detection (pending).

Run ConnectLED on a Windows 7 laptop with a licensed dongle at a range of 150' from the AreaMax.

CONNECTLED™ SOFTWARE	
37598451	25 UNIT LICENSE PACK*
41058338	PC DONGLE
39140436	AMAX, BLE REMOTE (commission/decommission only)

\*Delivery methods for ConnectLED may vary depending on quantity and preference. Please contact your sales agent for current information.

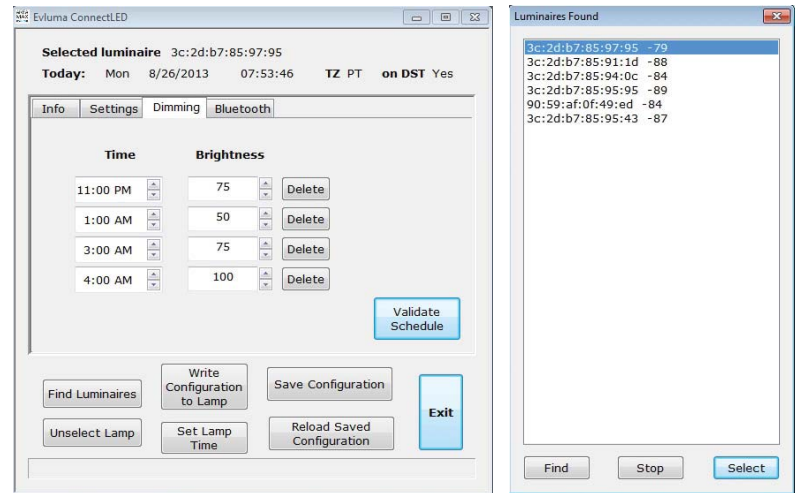

Setting the dimming schedule for a luminaire in ConnectLED

## Thermal Management

Evluma designed the AreaMax with two critical things in mind: maximum lumens per watt and maximum cooling. Low temperatures are key to LED long life and brightness. Critical components were selected for their minimum thermal resistance and paired with a custom light engine and casting design effectively executing this strategy.

In addition, LED life is assured by thermal management protection circuitry that controls current levels to the LEDs based on temperature. Temperature is measured at the LED package, often referred to as the solder point temp, or  $T_{SP}$ . At 65°C the fixture begins to cut back on the current to the LEDs to either maintain, or reduce the temperature back down to 65°C.

## 10 Year Warranty

Isofootcandle Lines at 25 ft mounting heights  
70W AreaMax = Solid Lines  
40W AreaMax = Dashed Lines

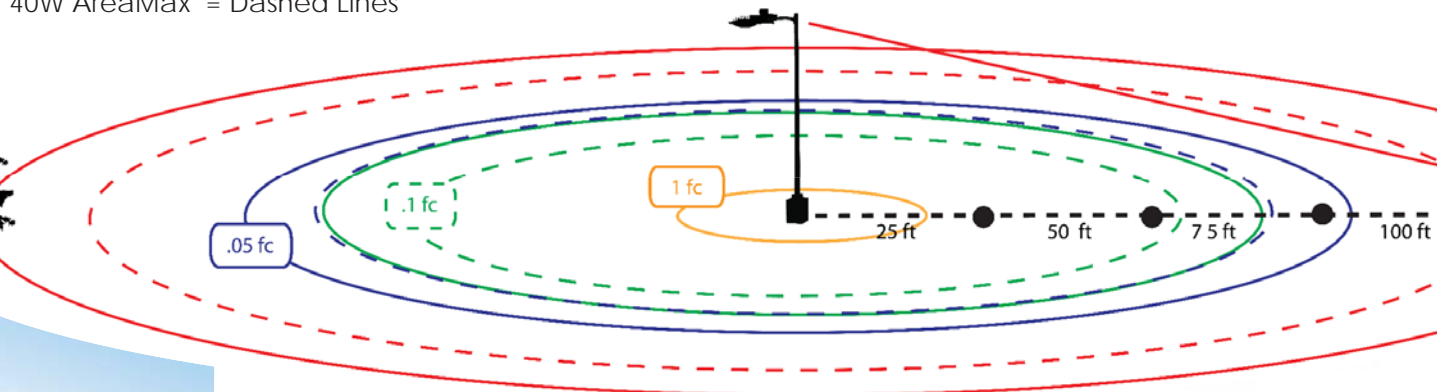

# A M A X - - - - -

PRODUCT ID	WATTS	PERFORMANCE CODES	PHOTOMETRIC TYPE	LENS
AMAX = AreaMax	40 = 40 watts**	4K-6 5K-6	V = Type V	C = Full Cut-Off D = Dome
	70 = 70 watts	5K-6	V= Type V	C = Full Cut-Off D = Dome **

**FC** Part 15 Class A



## PERFORMANCE CODES 40W

Code	CCT	CRI	Lumens	LED mA	BUG	IES File Numbers
4K-6 (D)	4500K	>70	>3000	700mA	B2-U2-G1	ITL75686+75689
5K-6 (D)	5500K	>65	>3500	700mA	B2-U2-G1	ITL75687+75690
4K-6 (C)	4500K	>70	>3000	700mA	B1-U0-G1	ITL75688+75691
5K-6 (C)	5500K	>65	>3500	700mA	B1-U0-G1	ITL75688+75690

## PERFORMANCE CODES 70W

5K-6 (D)	5500K	>65	>6000	700mA	B3-U3-G2	ITL79755+79776
5K-6 (C)	5500K	>65	>6000	700mA	B2-U0-G1	ITL80748+80749

## ELECTRICAL PERFORMANCE

- 90-277 VAC 50/60 Hz (.32 Amps at 120VAC)
- Power Factor >95%
- THD <10% at 120 VAC, <20% at 277 VAC
- **Replaceable** high capability surge protection for 20kV/10kA per IEEE/ANSI C62.42.2 - 2002. Location Category C-High
- <1/2 W Off-state power (not including photocontrol)

89076826 SURGE BOARD REPLACEMENT KIT, AREAMAX  
 26171146 LENS REPLACEMENT KIT, AREAMAX

## COMBINED PAYBACK MODEL

	40W AreaMax	100W HPS
Purchase Price (MSRP)	\$225.00	\$90.00
Asset Life	20 years	10 years
Maintenace Cost: 10 years	\$0.00	\$750.00***
Energy Cost: 10 years @ .08/KwHr	\$132.48	\$331.20
Cost of Ownership: 10 years incl. 3% finance charge for 5 years	\$414.42	\$1357.74
Annualized Cost: 10 years	\$41.44	\$135.77
Monthly Rental Rate @ Break Even	\$3.45	\$11.31
***HID photocontrol and lamp service calls		
<b>Simple Payback at HPS rental rate</b>	<b>3.05 years</b>	

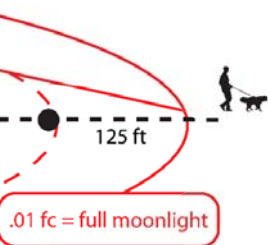

L70 at >100,000 Hours.  
 \*\*DLC Qualified. RoHS Compliant  
 Temperature rated at -40°C to 50° C  
 LM-79, IES & In-Situ Files Available  
 Thermal Management Protection Circuitry  
 Made in the USA of US and Imported Parts



Photocontrol and mounting arm are not included.

## POLAR CANDELA DISTRIBUTION

Vertical Plane (1) and Horizontal Cone (2) through maximum candela

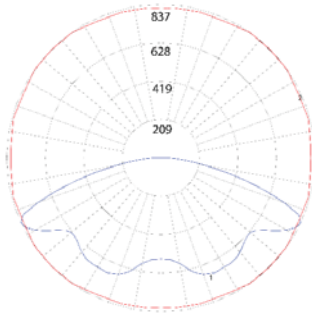
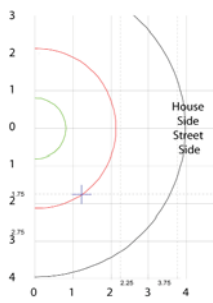

40W Dome Lens: Max Candela: 837 at 65° Angle  
.01 fc at 4 25' mtg htgs B2-U2-G1. ITL75687

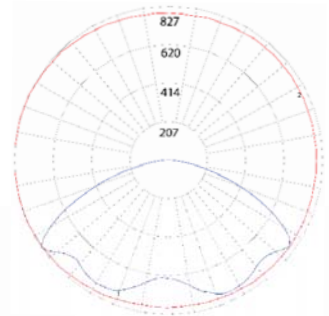
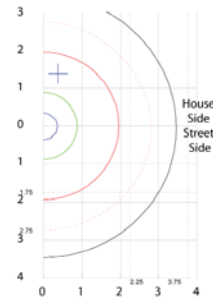

40W Flat (Full-Cutoff) Lens Max Candela: 811 at 55° Angle  
.01 fc at over 3 25' mtg htgs. B1-U0-G1. ITL75688.

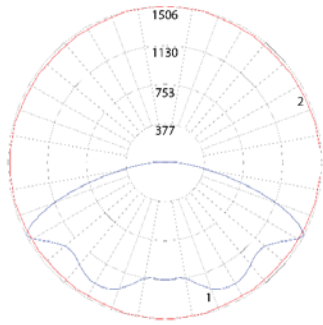
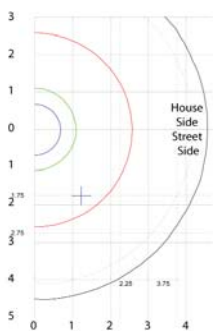

70W Dome Lens: Max Candela: 1506 at 62° Angle  
.01 fc at >4 25' mtg htgs B3-U3-G2. ITL79755

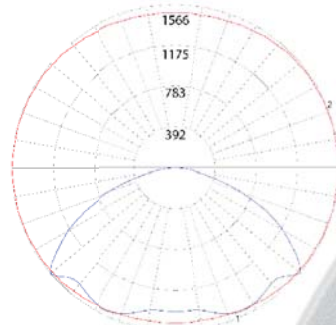
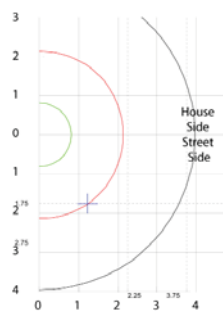

70W Flat (Full-Cutoff) Lens: Max Candela: 1566 at 50° Angle  
.01 fc at over 3 25' mtg htgs B2-U0-G1. ITL80748

## DIMENSIONS

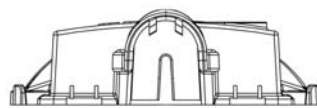
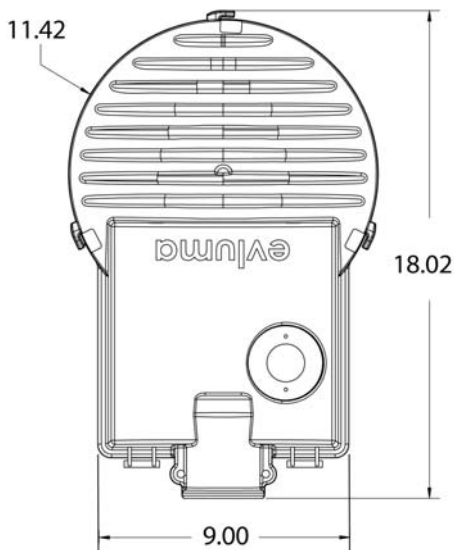

accepts 2" or 1 1/4" arm

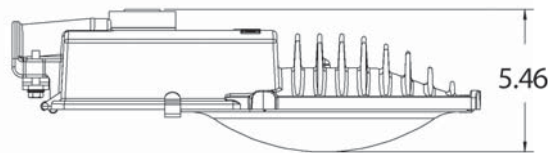

## CONSTRUCTION

- 16-32 long life LEDs: CREE XTEAWT
- high efficiency reflective optics
- textured & tempered glass lens
- die cast aluminum housing with grey powder coat
- accepts 2" or 1 1/4" arm
- performs to IP66 standards
- factory installed 66" pigtail
- weight = 9lbs