

ULTRA LOW CAPACITANCE STEERING DIODE/TVS ARRAY

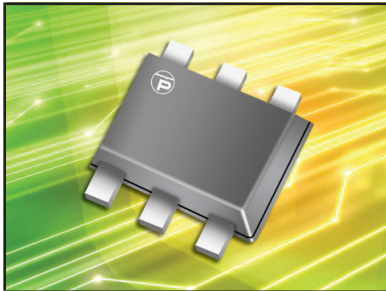

SC-89 PACKAGE

DESCRIPTION

The PLR0502-6 is an ultra low capacitance (0.7pF typical) steering diode and TVS array combo. This device provides circuit protection for interfaces and wireless bus applications and portable electronics. The PLR0502-6 is ideally suited to protect USB(1.0-3.1), Gigabit Ethernet, HDMI (2.0 & 4K) data I/O ports against the effects of ESD and EFT.

The PLR0502-6 meets the requirements of IEC 61000-4-2 (ESD) and IEC 61000-4-4 (EFT). At higher operating frequencies or faster edge rates, insertion loss and signal integrity are a major concern. The PLR0502-6 offers a ultra low capacitance and low leakage current in a SC-89 package.

FEATURES

- IEC 61000-4-2 (ESD) Compliant: Air ± 15 kV, Contact ± 8 kV
- IEC 61000-4-4 (EFT) Complaint
- IEC 61000-4-5 (Surge): 3A, 50W, 8/20 μ s
- Low Clamping Voltage
- Low Leakage Current
- Unidirectional Configuration
- Protects 2 I/O Ports and Power Supply
- Ultra Low Capacitance: 0.7pF (Typical I/O - I/O)
- RoHS Compliant
- REACH Compliant

APPLICATIONS

- USB (1.0 to 3.1)
- HDMI (2.0 & 4K)
- Gigabit Ethernet
- DVI
- IEEE 1394 FireWire

MECHANICAL CHARACTERISTICS

- Molded JEDEC SC-89 Package
- Approximate Weight: 3.05mg
- Lead-Free Pure-Tin Plating (Annealed)
- Solder Reflow Temperature:
Pure-Tin - Sn, 100: 260-270°C
- 8mm Tape and Reel Per EIA Standard 481
- Flammability Rating UL 94V-0

PIN CONFIGURATION

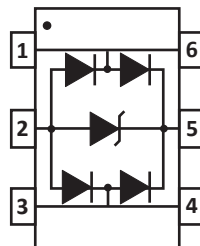

TYPICAL DEVICE CHARACTERISTICS
MAXIMUM RATINGS @ 25°C Unless Otherwise Specified

PARAMETER	SYMBOL	VALUE	UNITS
Operating Temperature	T_J	-55 to 125	°C
Storage Temperature	T_{STG}	-55 to 150	°C
Peak Pulse Power ($t_p = 8/20\mu s$) - See Figure 1	P_{PP}	50	Watts
ESD per IEC 61000-4-2 (Air)	V_{ESD}	±25	kV
ESD per IEC 61000-4-2 (Contact)	V_{ESD}	±15	kV

ELECTRICAL CHARACTERISTICS PER LINE @ 25°C Unless Otherwise Specified

PART NUMBER	DEVICE MARKING	RATED STAND-OFF VOLTAGE V_{WM} VOLTS	MINIMUM BREAKDOWN VOLTAGE @1mA $V_{(BR)}$ VOLTS	MAXIMUM CLAMPING VOLTAGE (Fig. 2) @ $I_p = 1A$ V_C VOLTS	MAXIMUM CLAMPING VOLTAGE (Fig. 2) @ $I_p = 3A$ V_C VOLTS	MAXIMUM LEAKAGE CURRENT @ V_{WM} I_D μA	MAXIMUM CAPACITANCE I/O - I/O (Note 1) @0V, 1MHz C_J pF
PLR0502-6	P26	5.0	6.0	11.0	17.0	1	0.7

NOTE

1. Maximum capacitance between I/O to GND is 0.9pF.

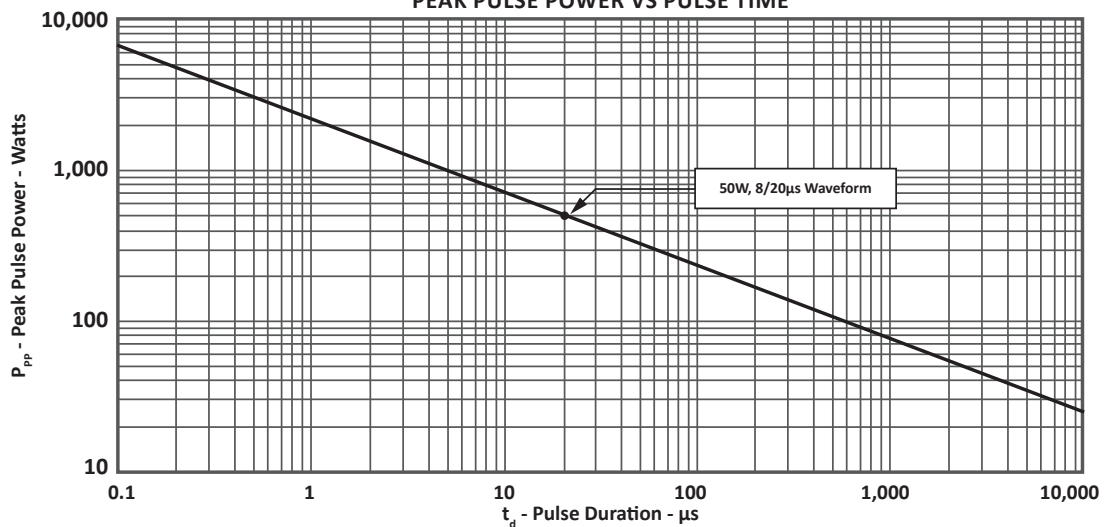
**FIGURE 1
PEAK PULSE POWER VS PULSE TIME**

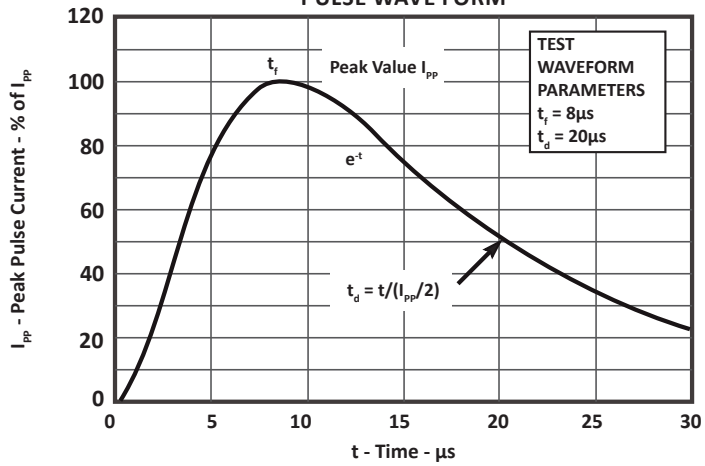
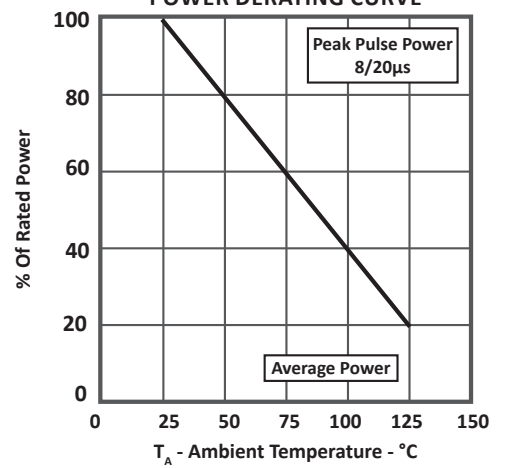
TYPICAL DEVICE CHARACTERISTICS
**FIGURE 2
PULSE WAVE FORM**

**FIGURE 3
POWER DERATING CURVE**

SC-89 PACKAGE INFORMATION

OUTLINE DIMENSIONS

DIM	MILLIMETERS		INCHES	
	MIN	MAX	MIN	MAX
A	0.50	0.60	0.019	0.024
B	0.15	0.30	0.005	0.012
c	0.10	0.18	0.003	0.007
D	1.50	1.70	0.059	0.067
E	1.55	1.70	0.061	0.067
E1	1.10	1.25	0.043	0.049
e	0.50 BSC		0.020 BSC	
L	0.10	0.30	0.003	0.012
L1	0.10	0.20	0.003	0.008

NOTES

1. Controlling dimension: millimeters.
2. Dimensioning and tolerances per ANSI Y14.5M, 1985.
3. Dimensions are exclusive of mold flash and metal burrs.

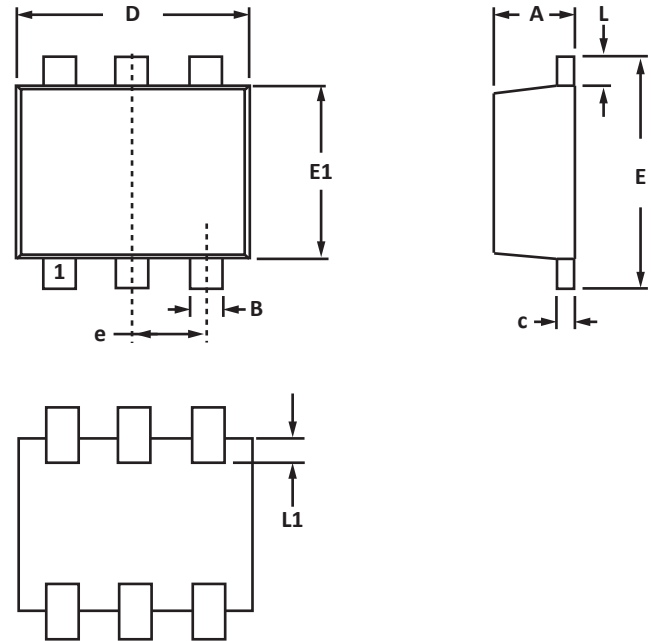

PAD LAYOUT DIMENSIONS

DIM	MILLIMETERS	INCHES
	NOMINAL	NOMINAL
C	1.45	0.057
P	0.50	0.020
G	0.60	0.024
X	0.30	0.012
Y	0.85	0.033
Z	2.30	0.090

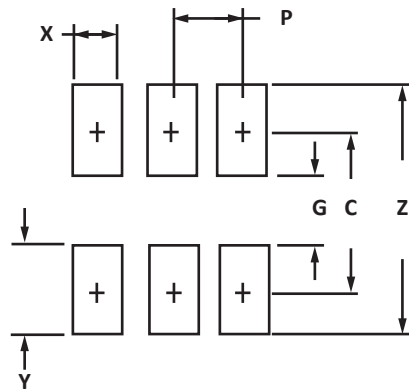

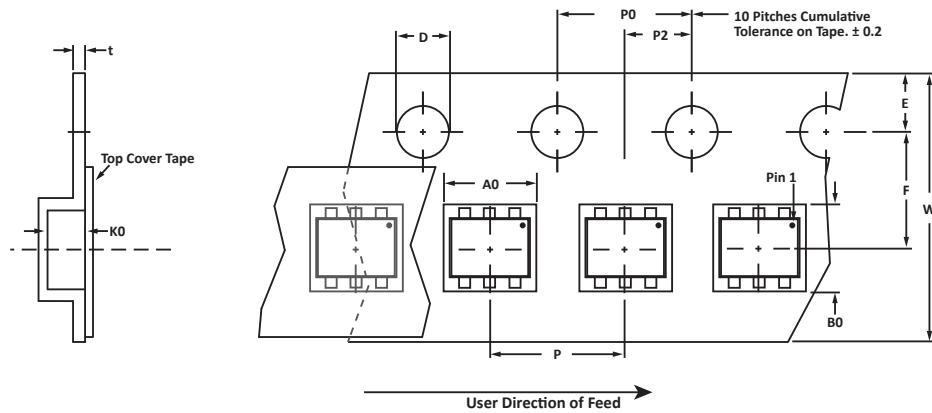
TAPE AND REEL

SPECIFICATIONS

REEL DIA.	TAPE WIDTH	A0	B0	K0	D	E	F	W	P0	P2	P	tmax
178mm (7")	8mm	1.77 ± 0.05	1.78 ± 0.05	0.67 ± 0.05	1.50 ± 0.10	1.75 ± 0.10	3.50 ± 0.05	8.00 ± 0.30	4.00 ± 0.10	2.00 ± 0.05	4.00 ± 0.10	0.25

NOTES

- Dimensions are in millimeters.
- Surface mount product is taped and reeled in accordance with EIA-481.
- Suffix - T7 = 7" Reel - 3,000 pieces per 8mm tape.
- Marking on Part - marking code (see page 2) and pin one defined by dot on package.

ORDERING INFORMATION

BASE PART NUMBER	LEADFREE SUFFIX	TAPE SUFFIX	QTY/REEL	REEL SIZE	TUBE QTY
PLR0502-6	N/A	-T7	3,000	7"	N/A

This device is only available in a Lead-Free configuration.

COMPANY INFORMATION

COMPANY PROFILE

In business more than 20 years, ProTek Devices™ is a privately held semiconductor company. The company offers a product line of overvoltage protection and overcurrent protection components. These include transient voltage suppressor array (TVS arrays) avalanche breakdown diode, steering diode TVS array and electronics SMD chip fuses. These components deliver circuit protection in electronic systems from numerous overvoltage and overcurrent events. They include lightning; electrostatic discharge (ESD); nuclear electromagnetic pulses (NEMP); inductive switching; and electromagnetic interference (EMI) / radio frequency interference (RFI). ProTek Devices also offers LED wafer die for ESD protection and related high frequency products.

CONTACT US

Corporate Headquarters

2929 South Fair Lane
Tempe, Arizona 85282
USA

By Telephone

General: 602-431-8101
Sales: & Marketing: 602-414-5109
Customer Service: 602-414-5114
Product Technical Support: 602-414-5107

By Fax

General: 602-431-2288

By E-mail:

Asia Sales: asiasales@protekdevices.com
Europe Sales: europesales@protekdevices.com
U.S. Sales: ussales@protekdevices.com
Distributor Sales: distysales@protekdevices.com
Customer Service: service@protekdevices.com
Technical Support: support@protekdevices.com

ProTek Devices (Asia Pacific) Pte. Ltd.

8 Ubi Road 2, #06-19
Zervex
Singapore - 408538
Tel: +65-67488312
Fax: +65-67488313

Web

www.protekdevices.com

COPYRIGHT © ProTek Devices 2016 - This literature is subject to all applicable copyright laws and is not for resale in any manner.

SPECIFICATIONS: ProTek reserves the right to change the electrical and or mechanical characteristics described herein without notice.

DESIGN CHANGES: ProTek reserves the right to discontinue product lines without notice and that the final judgement concerning selection and specifications is the buyer's and that in furnishing engineering and technical assistance. ProTek assumes no responsibility with respect to the selection or specifications of such products. ProTek makes no warranty, representation or guarantee regarding the suitability of its products for any particular purpose, nor does ProTek assume any liability arising out of the application or use of any product or circuit and specifically disclaims any and all liability without limitation special, consequential or incidental damages.

LIFE SUPPORT POLICY: ProTek Devices products are not authorized for use in life support systems without written consent from the factory.