

# PS SERIES

Vertical Machining Centers





You are painfully aware of the limitations of your existing vertical machining centers. Your customers are demanding faster turnaround of the job, lower costs per part, while **requiring** better quality. Each new job has new challenges.

Competition comes not just from across town, but from across the globe.

Your future depends on finding a better solution. How can you overcome the challenges of faster cycle times, tighter tolerances and difficult materials with your existing machines and methods? How can you reach new markets, diversify and grow your business?

Makino is well known for bringing high performance, quality and reliability through its innovative machining centers, technologies and process know-how.

Now there is a new production standard, to help you compete and reach the production goals you have established.

The Makino PS-series vertical machining centers.

The PS-series sets a new production standard by combining the productivity of a Makino horizontal machining center with the versatility, flexibility and ease of use typical of a VMC. The PS-series has been designed with the perfect blend of speed, power, torque and accuracy to create a new standard of performance in a vertical machining center.

The machine construction, high performance spindle technology, ergonomic design and powerful control let you cut what you need to without limitations. Parts are easily loaded and unloaded. Data is effectively managed, programs run fast, tools last longer, chips and coolant aren't a problem. Now you can produce parts more efficiently, more effectively at a lower cost.

Set your new production standard, achieve your goals with Makino's new PS-series VMCs.

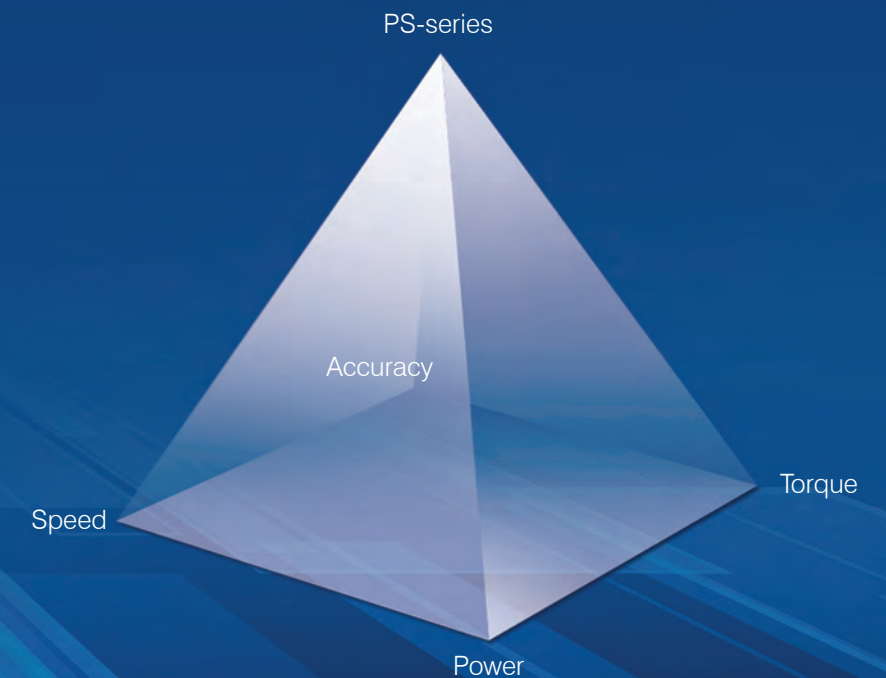

# POWERFUL STRUCTURE

A pyramid is the most stable geometric structure. It is sturdy, stiff and rigid. It derives its natural strength from each of the three sides which support the other two against lateral pressures. The pyramid will not change shape, bend, buckle, twist, warp or deform.

Likewise, the PS-series machine is designed – from the ground up – to provide outstanding stiffness, rigidity, thermal stability, speed, power and accuracy to tackle even the toughest production part materials and tolerances. Based upon a traditional C-frame approach and using heavy cast iron construction, the structure insures the quick, efficient transfer of the cutting forces through the various elements of the machine – from spindle into the column and ultimately the bed of the machine. Finite Element Analysis (FEA) design techniques were employed to perfect the massive cast bed, column, saddle, carrier and table components which provide optimal rigidity and torsional stiffness for ultimate performance characteristics and consistent results. The C-frame configuration provides the most effective utilization of machine mass offering the largest workzone in the smallest machine structure and footprint size. The design produces a lighter weight machine – with faster, quicker movements – leading to the highest level of productivity.

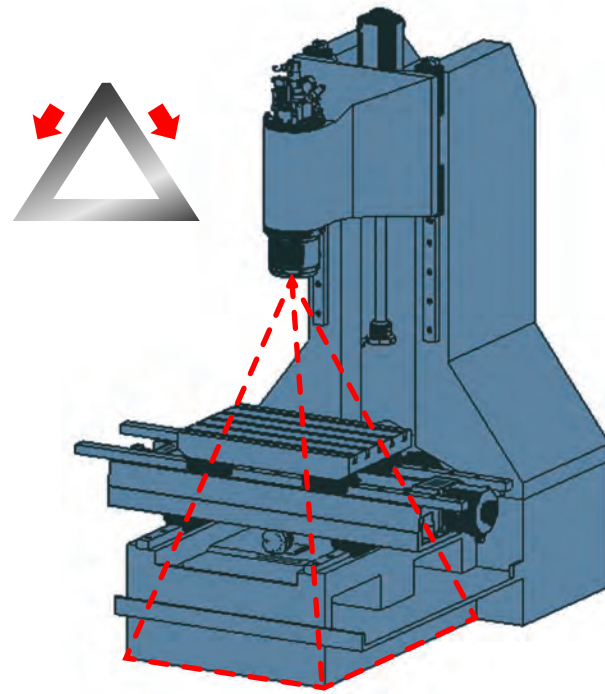

It all starts with the large machine bed casting which is the foundation for superior cutting performance, provides damping against vibration, and supports sustained accuracy for the life of the machine. The large, symmetrically designed bed casting maintains machine basic geometries and uniform thermal characteristics – even in shops with changing temperatures and provides a wide stance for the machine structure. An optimized leveling system provides pinpoint support for the workload and cutting forces. The design insures uniform loading on the leveling pads, facilitates optimized leveling, less deviation in loading, better support to the structure, more stability during motion, enhanced straightness and accuracy as well as providing smooth, quick, stable axis motion.

The spindle carrier blends a unique shape profile with strategically placed internal structure to create a stiff and rigid mounting for the spindle. The column is ribbed to provide strength and stability for vibration-free, chatter-free heavy machining. Wide at the bottom – to match the bed – the column stance assures stiffness, rigidity and dynamic stability for even, consistent Z – axis motion. Similarly, the saddle and table are heavily reinforced to provide support, stability and precise tracking throughout the workzone for the heaviest of workpieces.

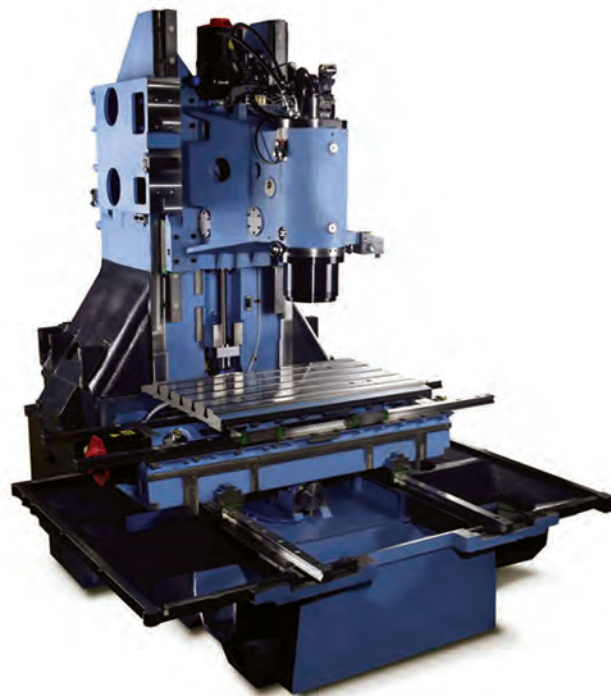

# PROCESS STABILITY

High performance linear guideways (utilizing “caged ball” technology) provide extremely precise, anti-friction motion. Optimum spread and stance of the linear guides provide outstanding, uniform full support across the entire axis travel, ease of motion, straightness of movement and provides a stable cutting platform. The design insures that the machine movements never extend beyond the underlying support providing stability, rigidity and precision of motion – even with the heaviest of workpieces and engaged in the most challenging of cuts. In addition, pre-tensioned, dual supported, large diameter ballscrews and powerful, direct-coupled, digital servo motors - tuned for peak performance - provide the axis thrust and performance characteristics for the most challenging applications. Quick “to-speed” and “from-speed” motion minimizes non-productive time on positioning moves that reduces cycle times and cuts part costs.

To insure highest functionality and productivity, with minimal operator intervention and associated downtime, the PS-Series machines are equipped with an automatic lubrication system for the guideway and ballscrew systems.

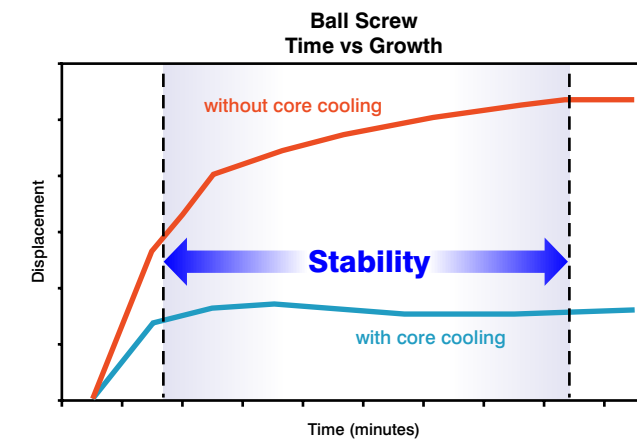
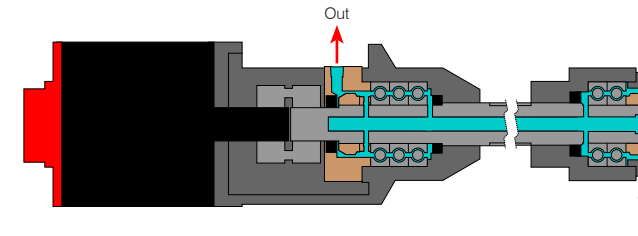
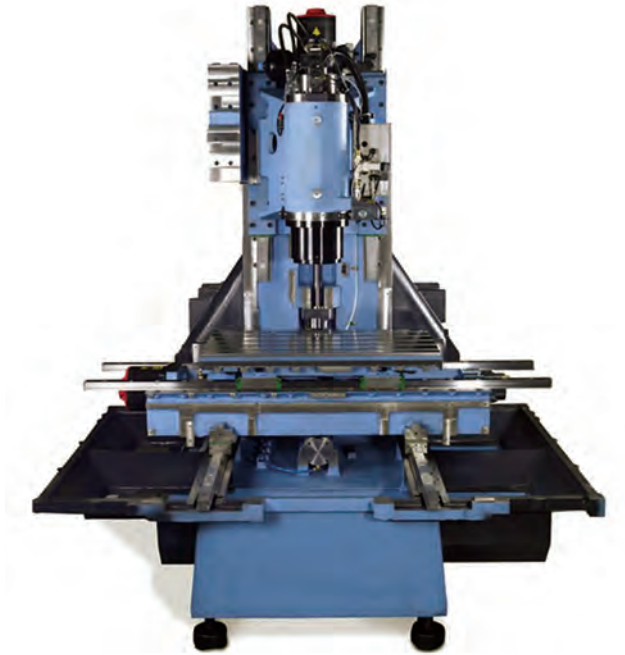

To control thermal growth within the ballscrew and drive systems, the PS-Series machine is equipped with core-cooled ballscrews. Temperature controlled oil is circulated through the ballscrew support bearings and the center of the ballscrews. This process manages and reduces thermal growth, significantly shortens the thermal saturation time – virtually eliminating “warm-ups”, maintains a lower system operating temperature, controls thermal drift and enhances accuracy. The PS-Series machines are ideally suited to provide consistent quality and precision for those long, demanding production runs. Combined with the cooled ball screws and support bearings and a closed-loop temperature compensation system, the symmetrical nature of the casting secures the tightest tolerance and minimal variations during long production part runs.

Together with absolute million pulse per revolution Fanuc servo motors, these machine design features reduce variability for hours of continuous, tight tolerance machining - providing the PS-Series machines with outstanding production tolerance performance:

- Linear Positioning Accuracy:  $\pm 0.000100''$  ( $\pm 0.0025$  mm)
- Repeatability:  $\pm 0.000078''$  ( $\pm 0.0020$  mm)

Makino's leadership in spindle technology is renowned throughout the world. Spindle rigidity, higher rpm, constant pre-load, multi-plane balancing, minimizing vibration, and controlling thermal growth are all issues that Makino has solved through years of experience and application of spindle design, manufacture, and assembly.

Fashioned after the a51 Horizontal Machining Center spindle, designed for flexibility and high productivity, the PS-Series' standard 14,000-rpm, CAT40 spindle offers the ideal blend of speed, power and torque. Duty rated at 33.5 HP (24.2 HP continuous) and 130 ft-lbs/175.1 Nm peak torque (70.5 ft-lbs/95.5 Nm continuous) the spindle offers efficient, highly productive machining characteristics to address a wide range of materials typical of the production environment. The two-range, cartridge design spindle provides stiffness and rigidity at the lower ranges – for roughing operations in tough materials - yet, offers the vibration and chatter-free, high spindle speed cutting capability needed to be productive in aluminum applications. Large diameter bearings, air – oil lubrication and jacket-spindle temperature-control provide long-term thermal stability and stiff, rigid, chatter-free cutting.

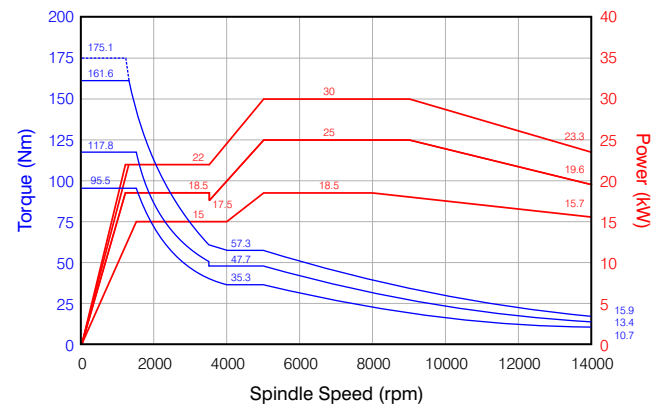
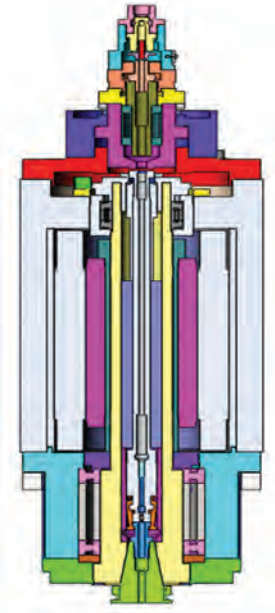

The incorporation of a large capacity, heat dissipating spindle chiller (or Oilmatic Unit) closed – loop linked with a thermocouple that monitors the machine bed temperature, maintains the thermal stability of the entire system. Controlled oil is circulated in a jacket surrounding the spindle and then routed through the ballscrew support bearings and center of the ballscrews – creating an “on machine” ambient manufacturing zone that minimizes the thermal impact and provides process consistency.

The PS - Series rigid construction, thermal stability and wide-ranging spindle are ideal for a variety of applications, including automotive, aerospace, medical and other production part manufacturing applications.

As an optional configuration, the PS-Series, standard 14,000 rpm spindle, can be configured with an HSK-A63 spindle interface. For even more productivity in aluminum and other higher spindle speed applications, the PS-Series is also available with an optional 20,000 rpm, HSK-A63 spindle.

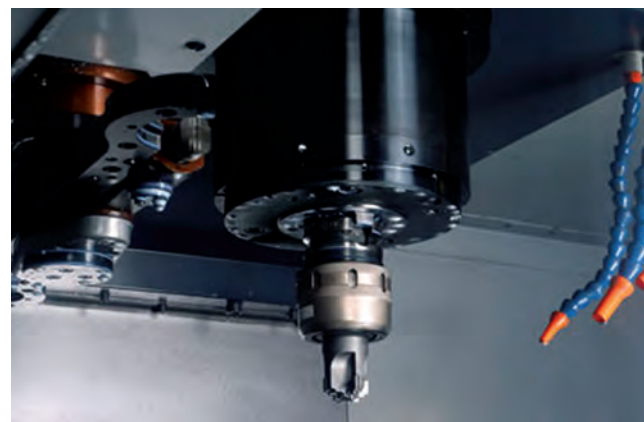

Equipped with a 30-tool magazine, the PS – Series machine offers sufficient capacity for a wide variety of production applications. The Automatic Tool Changer (ATC) is a highly reliable, field-proven bi-directional, random access design that provides a very quick and reliable tool exchange. A mechanically linked, cam driven tool exchange arm and double gripper system is the source of very quick and efficient tool exchange. In addition, the tool change offers “special” tool change functionality for large, heavy and fixed tool processing. The intelligent, ATC encoder design also provides auto – recovery capability.



An integral ATC shutter separates the machine cutting zone from the tool magazine, assuring that chips and coolant from the machining area do not migrate into the tool magazine



The tool changer door provides ready access for easy loading and unloading of tooling to the machine magazine. An ATC control panel is located adjacent to the tool changer door to assist the operator in manual operation of the tool magazine – permitting exchange and maintenance of tooling while maintaining spindle utilization. Two tooling queue spots are located within the ATC cabinet to assist the operator with tool replenishment and upkeep.





Created with the production environment in mind, the PS-Series chip and coolant systems enhance the productivity of the machine. Configured with flood, overhead-shower, flush and through spindle coolant as standard features, chips are efficiently and effectively removed from the cutting zone. Spiral chip augers located in the front and rear of the worktable quickly and efficiently evacuate chips and coolant from the machining zone and into a standard lift-up chip conveyor (LUCC). A variety of LUCCs are integrated with the machine to tailor the chip handling to the specific need of the application.

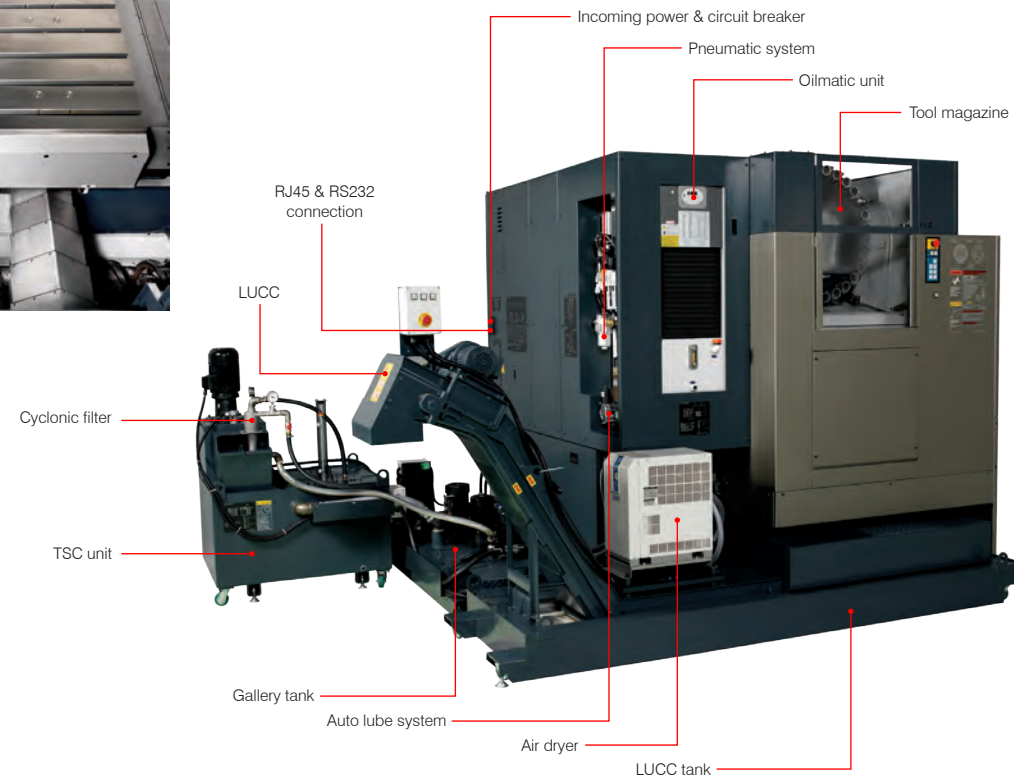
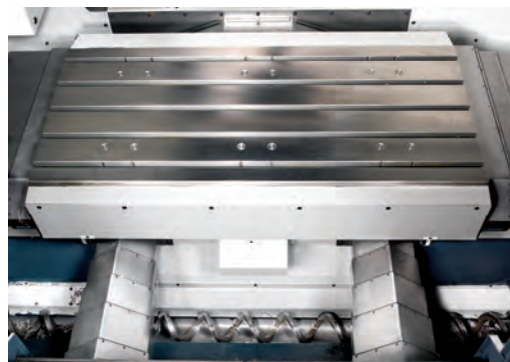

The chip and splashguard fully encloses the machining area to prevent flying chips and coolant from escaping outside the machine during manufacturing operations. The large, front operator windows provide outstanding visibility of the entire workzone.



Combined with the "toward the operator" movement of the table and the convenient table loading height, the PS-series machines offers outstanding ergonomics which significantly reduces part exchange load times and operator fatigue.

The machine control is on a pivot that provides 90° of swing. This assures the operator will always have easy access to the control during set-up, program prove-out, operation and even manual tool loading through the front of the machine.

The chip and splashguard doors are strategically designed wider than the respective X – axis travel thereby insuring that full-size workpieces can be easily accommodated. In addition, the machine ceiling opens, together with the operator doors, to facilitate easy handling of large, heavy workpieces and fixtures that require an overhead crane.



# PROGRAM SELECTION

The PS-Series features Makino's new Professional P control software configured to support a wide variety of applications in the job-shop and production environment. With a large color LCD, menu-driven, touch-sensitive screen, information is only a "touch" away. Configured with generous program storage (4,200-foot), 400 registerable programs, 400 tool-offset pairs and 48 pairs of work coordinate systems, the Professional P provides ample standard capabilities for production shops of all sizes.

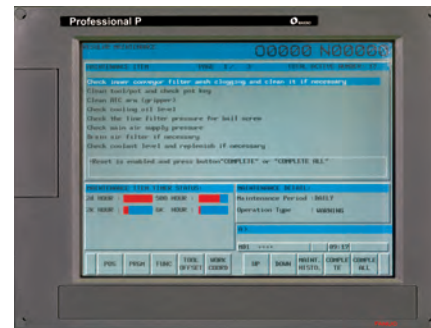

# POPULAR SOLUTIONS

The PS-Series is an ideal choice for shops looking to get fully configured, wide-ranging, "top shelf" machining performance and superior machining results at a reasonable investment - a true value proposition. However, from time-to-time, optional content may be added to the machine to enhance the capability and performance. These may include 4th axis tables, tool length measurement, spindle probe, 20,000 rpm spindle, palm buttons, light curtain, auto doors, and a variety of other features.

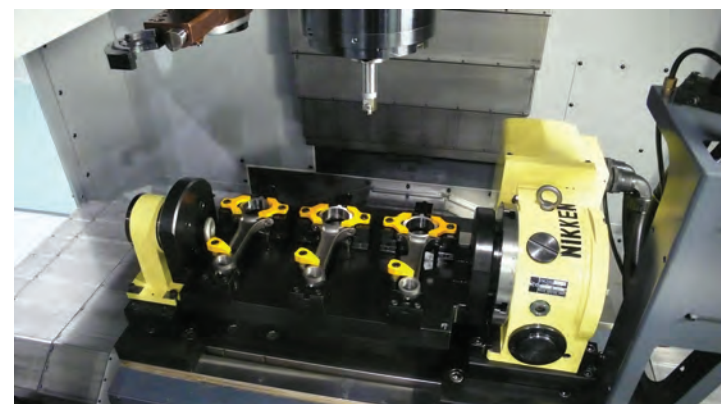

# PRODUCT SPECIFICATIONS

	PS65	PS95
<b>Travels:</b>		
X:	660 mm (26.0")	920mm (36.2")
Y:	510 mm (20.0")	510 mm (20.0")
Z:	460 mm (18.1")	460 mm (18.1")
<b>Table:</b>		
Width:	510mm (20.0")	510mm (20.0")
Length:	920mm (36.2")	1,170mm (46.0")
Load Capacity:	600 kg (1,323 lbs)	800 kg (1,763 lbs)
Type of Axis Drives:	AC Absolute Digital Servo Motors	AC Absolute Digital Servo Motors
Bed Construction:	Meehanite Cast Iron	Meehanite Cast Iron
<b>Axis Design:</b>		
Linear Guides		
<b>Size &amp; Number of Trucks:</b>		
X:	45mm x 4	45mm x 6
Y:	45mm x 4	45mm x 4
Z:	55mm x 4	55mm x 4
<b>Ballscrew:</b>		
Core-cooled		
Diameter:	45mm (1.77")	45mm (1.77")
<b>Rapid Rate:</b>		
X&Y Axes:	36m/min (1,417 ipm)	36m/min (1,417 ipm)
Z Axis:	30m/min (1,181 ipm)	30m/min (1,181 ipm)
Feed Rate:	0 to 30m/min (0 to 1,181 ipm)	0 to 30m/min (0 to 1,181 ipm)
<b>Spindle Taper:</b>		
Standard:	CAT #40	CAT #40
Optional:	HSK-63A	HSK-63A
Spindle Speed:	50 to 14,000 rpm	50 to 14,000 rpm
<b>Spindle Speed Ranges:</b>		
2 Electronic		
<b>Spindle Drive Motor (hp):</b>		
Duty (30 minute):	25 kW (33.5 hp)	25 kW (33.5 hp)
Continuous:	18 kW (24.2 hp)	18 kW (24.2 hp)
<b>Spindle Torque:</b>		
Peak (15% ED):	175.1 Nm (130 ft-lbs)	175.1 Nm (130 ft-lbs)
15 minute:	117.8 Nm (86.9 ft-lbs)	117.8 Nm (86.9 ft-lbs)
Continuous:	95.5 Nm (70.4 ft-lbs)	95.5 Nm (70.4 ft-lbs)
<b>Spindle Lubrication:</b>		
Air - Oil		
Temperature Controller:	Spindle & Core-cooled Ballscrews	Spindle & Core-cooled Ballscrews
Spindle Nose to Table:	150mm to 610mm (5.9" to 24")	150mm to 610mm (5.9" to 24")
<b>Automatic Tool Changer:</b>		
Capacity (standard):	30	30
Capacity (option):	50	50
<b>Maximum Tool Sizes:</b>		
All pockets full:	76mm (3.0")	76mm (3.0")
Adjacent pockets empty:	125mm (4.92")	125mm (4.92")
Maximum tool length:	300mm (11.8")	300mm (11.8")
Maximum Tool Weight:	8 kg (17.6 lbs)	8 kg (17.6 lbs)
<b>Tool Change Time:</b>		
Tool-to-tool:	1.2 seconds	1.2 seconds
Chip-to-chip:	3.8 seconds	3.8 seconds
<b>Positioning Accuracy:</b>		
Standard:	±0.0025mm (±0.000100")	±0.0025mm (±0.000100")
Optional Moiré Scales:	±0.0015mm (±0.000060")	±0.0015mm (±0.000060")
<b>Repeatability:</b>		
Standard:	±0.002mm (±0.000078")	±0.002mm (±0.000078")
Optional Moiré Scales:	±0.001mm (±0.000040")	±0.001mm (±0.000040")
Coolant Capacity (all):	870 liters (230 gallons)	870 liters (230 gallons)
Machine Weight:	6,600 kg (14,550 lbs)	6,800 kg (14,987 lbs)

## General Arrangement

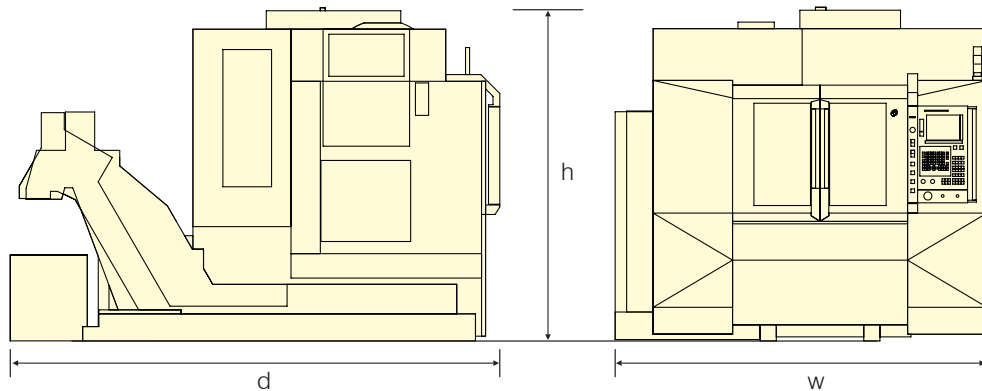

	Height (h)	Width (w)	Depth (d)
<b>PS65</b>			
with scraper & hinged belt LUCC	2,479mm (97.6")	2,467mm (97.1")	3,503mm (137.9")
with scraper - drum LUCC		2,552mm (100.5")	3,553mm (139.9")
<b>PS95</b>			
with scraper & hinged belt LUCC	2,479mm (97.6")	2,677mm (105.4")	3,503mm (137.9")
with scraper - drum LUCC		2,762mm (108.7")	3,553mm (139.9")



**Die/Mold Technology Center**  
2600 Superior Court  
Auburn Hills, MI 48326  
248-232-6200

**Makino USA**  
7680 Innovation Way  
Mason, Ohio 45040  
513-573-7200

**Makino Southern California**  
17800 Newhope Street, Suite K  
Fountain Valley, CA 92708  
714-444-4334

**Makino Midwest**  
1135 Jansen Farm Drive  
Elgin, IL 60123  
847-468-1295

**Makino Wichita**  
2333 S. West St. Bldg #100, Suite #103  
Wichita, KS 67217  
316-729-2610

**Makino Wisconsin**  
W229 N2510 Duplainville Rd. Unit 2  
Waukesha, WI 53186  
262-574-7554

**Makino Canada (Montreal)**  
2820 De Miniac  
St. Laurent, QC H4S 1K9  
514-333-5793

**Makino Canada (Toronto)**  
170 Ambassador Drive Unit #1  
Mississauga, ON L5T 2H9  
905-565-6886

**Makino South**  
26762 Success Drive  
Madison, AL 35756  
256-301-0040

**Makino Mexico**  
Retorno El Marques #3  
Parque Industrial El Marques  
Querétaro, México CP 76240  
442-253-1003

**Makino Mexico**  
Ave. Universidad #1080-10 Col. Universidad  
Saltillo, Coahuila, Mexico CP 25260  
442-101-6000

This document and its contents are the property of Makino Inc. No disclosure, duplication, or use of any portion of this document or its contents for any purpose contrary to the interests of Makino Inc. may be made without prior written consent of Makino Inc.

Manufacturer's specifications are accurate as of the date of publication and may be changed without prior notice to incorporate improvements resulting from ongoing R&D programs.

©Copyright 2011 Makino