



**Blaze Aisle Lighting**  
ELEGANT PERFORMANCE

## Blaze Aisle Lighting - Product Range

### ★ DALI



DALI stands for Digital Addressable Lighting Interface. Connected with a computer / tablet / mobile phone you can control the lighting terminal through operational software. We can accurately control each lamp in a certain area.

Part Numbers	GEL-AL-30W	GEL-AL-60W	GEL-AL-90W
Lumen Output	3,300 Lumens	6,600 Lumens	9,900 Lumens
Power	30 Watts	60 Watts	90 Watts
Efficacy	110 Lm / W (CCT = 5000K)		
CCT	3000K, 4000K, 5000K		
CRI	70 Ra, 80 Ra, 90 Ra		
Beam Angle	30° x 70° , 60° x 90° , 120°		
Nichia LED Chips	28 pcs	56 pcs	84 pcs
Input Voltage	AC 100-277 Volts, 47-63Hz, PF ≥ 0.93		
IP Rating	IP65 Weatherproof		
Driver	Meanwell Driver		

Part Numbers	GEL-AL-120W	GEL-AL-150W	GEL-AL-180W
Lumen Output	13,200 Lumens	16,500 Lumens	19,800 Lumens
Power	120 Watts	150 Watts	180 Watts
Efficacy	110 Lm / W (CCT = 5000K)		
CCT	3000K, 4000K, 5000K		
CRI	70 Ra, 80 Ra, 90 Ra		
Beam Angle	30° x 70° , 60° x 90° , 120°		
Nichia LED Chips	112 pcs	140 pcs	168 pcs
Input Voltage	AC 100-277 Volts, 47-63Hz, PF ≥ 0.93		
IP Rating	IP65 Weatherproof		
Driver	Meanwell Driver		

### Blaze LED Aisle Lighting - Mounting Options

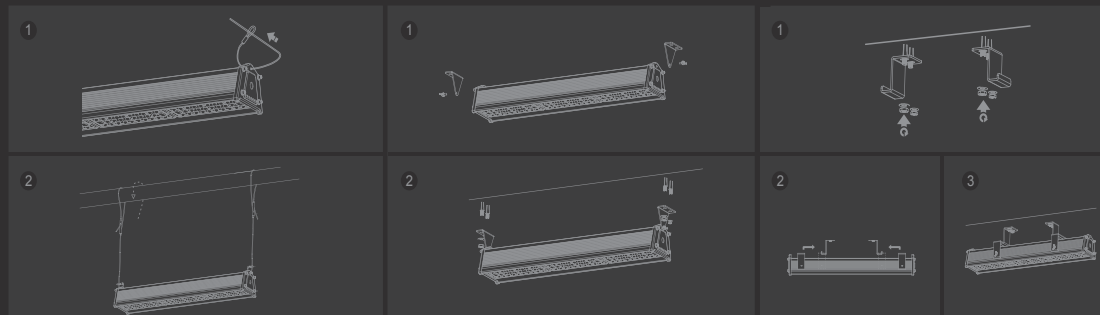

## Global Energy & Lighting

**Executive Offices:**  
439 East Shore Drive  
Eagle, Idaho 83616

**R&D:**  
560 South Winchester Boulevard Suite 500  
San Jose, California 95128

**Toll Free:**  
1 (800) 992-7370

www.GEL-USA.com

**GLOBAL**  
ENERGY & LIGHTING



# Blaze Aisle Lighting

THE LED LIGHT FOR WAREHOUSE AISLES  
INTELLIGENT INTEGRATED OCCUPANCY SENSOR & CONTROL INTERFACE

Blaze LED Aisle Lighting was born for warehouse aisles, generating rectangular lighting patterns and providing an intelligent high bay solution, ideal for this environment.

## ★ Lumen Efficacy

110 Lm / W

Eos



85 Lm / W

Standard High Bay



Global Blaze LED Aisle lighting has a high system efficacy, up to 110 Lm / W. Compared to general COB and HID, Blaze saves more than 80% energy.

## ★ Beam Angle

The Blaze LED Aisle family has various wattage options (30W-180W) available in different beam angles: 30x70°, 60x90° or 120°.

Blaze LED Aisle Lighting

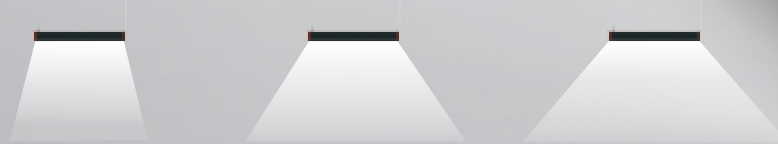

Lighting Pattern



Beam Angle                      30° x 70°                      60° X 90°                      120°

Application                      Warehouse Aisles                      Warehouse & Workplane                      Docking Areas



## ★ Wireless Controls

You can remotely control the Blaze lighting system on / off and dimming using your mobile phone / tablet at home or on the go, or by remote control.



REMOTE



PHONE

DALI Control App

## ★ Motion Sensor



»» WHEN ENTERING

The sensor automatically turns lights on when motion is detected.

## ★ Daylight Sensor

100% SUNNY DAY

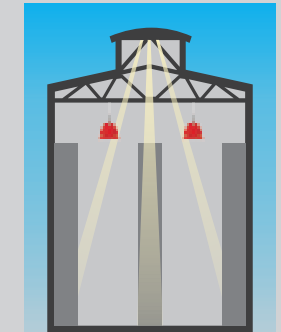

With sufficient sunlight, the daylight sensor will turn lamp(s) off, even when motion detection is enabled.

50% CLOUDY DAY

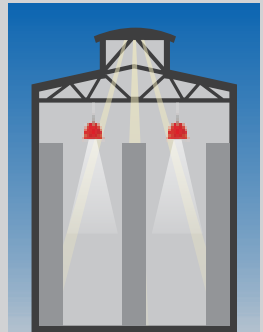

If ambient light goes down to 50% of the preset illumination level, lamp(s) will switch on.

0% NIGHT TIME

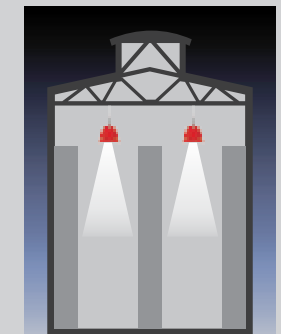

When ambient light goes below the preset illumination level, or down to 0%, lamps switch on automatically.

HOLD TIME

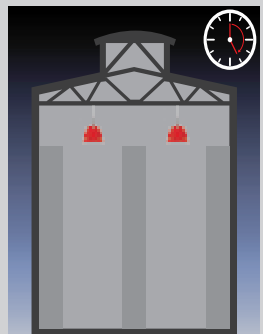

If no motion is detected for the preset time period lamps will shut off.

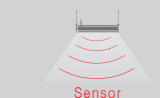

Sensor



Slaves

»» WHEN LEAVING



When people leave the detection area, light will dim to a preset illumination level or can turn off completely.