

LCR-Reader[®]

All-in-One

Digital Multimeter Tweezers



L-C-R 0.1% Basic Accuracy
AC/DC Voltage/Current
LED/Diode/Continuity Test
Oscilloscope
Frequency, Pulse Period, Duty Cycle
Signal Generator
Super Cap Testing

Test Frequency: 100 Hz to 100 kHz
Test Signal Level: 0.1, 0.5, 1.0 Vrms

Model LCR-MPA
User Manual

 **SIBORG**
SYSTEMS INC

1	Device Use	2
1.1	Main Features	2
2	What is included in the package	3
3	Symbols and Abbreviations	3
4	Principle of Operation	3
4.1	Calculation of Parameters:	4
5	Safety Measures and General Instructions	5
6	Device Controls	6
6.1	Turning on the Device	6
6.2	Turning Off the Device	6
6.3	Controlling Device Using Its Orientation	6
6.4	Charging the Battery	7
6.5	Main and System Menu	7
7	Modes of Operation	8
7.1	R-L-C-D Mode	8
7.1.1	Measurements	9
7.1.2	Quick Controls	10
7.1.3	Relative (Tolerance) Measurements	10
7.1.4	Open/Short Calibration	10
7.1.5	Capacitance Offset Calibration Board	11
7.2	R-L-C-D mode menu	11
7.2.1	Primary Parameter	11
7.2.2	Secondary Parameter	12
7.2.3	Test Frequency	12
7.2.4	Test Signal Level	12
7.2.5	Period	12
7.2.6	SER/PAR Mode	12
7.2.7	Sound	13
7.2.8	Cap-Voltage	13
7.2.9	Sample Hold	13
7.2.10	Default	13
7.2.11	Large Cap	14
7.2.12	Large Cap (0.5 μ F to 40 mF) Settings	14
7.2.13	Super Large Cap > 40 mF Measurement	14
7.3	RDC+LED Mode	15
7.3.1	Auto Mode	15
7.3.2	Diode Mode	15
7.3.3	R test at 1.3 V and R test at 100mV	15
7.4	Voltage Mode	16
7.4.1	Controls	16
7.5	Transient Voltage Waveforms (Oscilloscope Mode)	17
7.5.1	Oscilloscope mode settings	17
7.6	Frequency Meter Mode	17
7.6.1	Changing the sub-mode	17
7.6.2	Frequency, Period control	17
7.7	Signal Generator Mode	18
7.7.1	Controls	18
7.8	System Menu Entries	18
7.8.1	Power	18

7.8.2	Sound	18
7.8.3	Display	18
7.8.4	Serial Number	19
7.8.5	Default	19
8	Device Troubleshooting	19
8.1	<i>If the device does not turn on</i>	19
8.2	<i>If there are no initial readings on the screen</i>	19
8.3	<i>Technical Support</i>	19
9	Maintenance	20
9.1	<i>General care of the device</i>	20
9.2	<i>Repairs</i>	20
10	Storage Conditions	20
11	Transportation	20
12	Warranty	20
13	Specifications	21
13.1	<i>Overview</i>	21
13.2	<i>FCC Compliance</i>	22
13.3	<i>General Information</i>	22
13.4	<i>Details of the Measurement Modes</i>	22
13.4.1	Test Signal Generator	22
13.4.2	Resistance	22
13.4.3	DC Resistance	23
13.4.4	Capacitance	23
13.4.5	DC Capacitance Measurement	24
13.4.6	Inductance	24
13.4.7	DC Voltage	24
13.4.8	AC Voltage	24
13.4.9	Low Frequency DDS Signal Generator	25
13.5	<i>Supplement A</i>	25
13.6	<i>Supplement B</i>	26

1 Device Use

1.1 Main Features

- Automatic component recognition L-C-R-Diode
- Basic Accuracy of 0.1%
- DC measurement of Resistance and Capacitance up to 1 F
- Pass/No Pass Electrolyte Cap indication with Built-in Rejection table
- Automatic/manual frequency setting 100, 120 Hz, 1, 10, 20, 30, 40, 50, 60, 75, 100 kHz
- Automatic adjustment of test signal to 0.1 V peak-to-peak for in-circuit measurements
- Designated ESR measurements
- Easy Open/Short calibration for better measurement accuracy
- Automatic detection of diode polarity and short circuit
- AC/DC voltage measurements
- Frequency meter

- Oscilloscope waveform display for AC voltage measurements
- Four-way joystick control
- Multiple Parameter Display: primary/secondary, etc.
- Automatic/Manual Right/Left hand screen orientation
- Sound indication
- Battery discharge warning, full charge indication
- Automatic power off
- Battery charge indicator
- Backlit LCD

2 What is included in the package

LCR-Reader MPA

Case

Capacitance Offset Calibration Board

Spare Ergonomic Bent Test Leads*

Spare Battery*

Kelvin Probe Connector*

* *Optional Accessories*

3 Symbols and Abbreviations

DUT – Device Under Test

ESR - Equivalent Series Resistance

Low ESR - Ultralow Equivalent Series Resistance

R_s - Series Resistance

L_s - Inductance *in series connection*

C_s - Capacitance *in Series Connection*

X_s - Reactance in Series connection

R_p - Resistance in Parallel connection

L_p - Inductance in Parallel Connection

C_p - Capacitance in Parallel Connection

X_p - *Reactance* in Parallel Connection

Q - Quality Factor

D - Loss Tangent

ϑ – Phase angle

RMS - *RMS value*

TRMS – *True RMS Value*

LF - Low Frequency

Z - Impedance

$|Z|$ - Impedance Module

DDS - Direct Digital Frequency Synthesis

DC - DC Voltage

AC - Alternating Voltage

4 Principle of Operation

Fig. 1 shows the LCR meter block-diagram. Voltage from the voltage source through a limiting 100 Ω resistor is applied to the DUT connected at points A and B. The amplitude and frequency of the Test Signal *V* are adjustable. It is *also possible to apply*

either positive or negative DC voltage to the DUT. A voltage drop on the DUT is measured by DAu. The voltage drop on resistor Rj measured by DAj is proportional to the current flowing through the measured component. After digitizing the ADC signals the impedance is calculated according to the formula DUT impedance $Z = R_j \cdot V_{au} / V_{aj}$.

Initial values of Impedance (offsets) obtained during calibration with Open and Short probes are stored in the non-volatile memory of the device and are considered in the calculation of the impedance of the measured component thus eliminating the offsets due to the device internal parasitics.

The measured component can be represented as one of the following equivalent circuits:

(1) and (2): AC measurement series circuits, (3) and (4): AC parallel circuits, (5,6,7) DC measurement of diodes, resistance and capacitance.

Impedance in series circuits is $Z = R_s + iX_s$ and in parallel circuits is $Z = 1 / (1/R_p + 1/iX_p)$ where $X_s (X_p) < 0$ if the reactance is Capacitive and at $X_s (X_p) > 0$ the reactance is Inductive.

4.1 Calculation of Parameters:

Capacitance $C = 1 / (2\pi f |X_s|)$ where f is the test frequency.

Inductance $L = X_s / (2\pi f)$. $Q = |X_s| / R_s$. $D = 1/Q$. $|Z| = \sqrt{R_s^2 + X_s^2}$

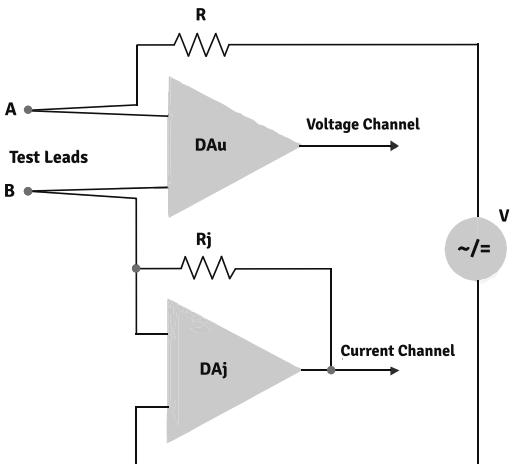

In automatic mode the device automatically selects the optimum frequency and the equivalent circuit for measurements. Users can also manually select measurement mode and frequency of

the test signal can be selected a range of fixed values from 100 Hz to 100 kHz. Test voltage can be set to 1.0, 0.5 and 0.1 Vrms.

By passing direct current through the measured component, the voltage and current can be measured. Using Ω 's law, the DC current Resistance (RDC) is calculated.

By applying the DC voltage in forward and reverse direction, the diodes are detected, and the polarity of p-n junction is determined.

For capacitors larger than 40 mF the capacitance is calculated using the voltage variation on the measured capacitor when it is charging for a certain time interval and applied current.

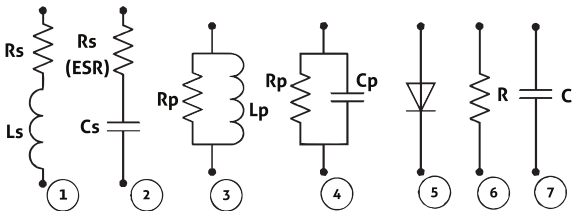

The principle of the frequency meter is based on the counting of pulses of the reference generator between the two ramps of the input signal for a certain period of time (by default about 1 second). At the same time, the quantity of periods of the input signal is counted too. Then the frequency f is calculated by the formula $f = M/N * f_r$, where M is the number of periods of the input signal, N is the number of pulses from the reference generator and f_r is the frequency of the reference generator.

The principle of measuring the voltage is based on comparing the input signal with the reference voltage.

5 Safety Measures and General Instructions

For safe and reliable operation of the device, follow these rules:

1. Exercise additional caution when measure the capacitance, inductance, resistance and diodes in a live circuit
2. Never apply voltage to the probes when the device is in the R-L-C-D, RDC+LED or Generator mode.
3. Never apply more than 20 V DC or 14 Vrms to the probes when the device is in Voltage, Frequency or Oscilloscope mode.
4. Never measure Charged Capacitors
5. Do not make measurements while the device is charging
6. Charge the battery using a USB port of a computer or a DC charger 5 V +/- 5%. Do not use damaged cables or chargers.

7. Do not stretch the handles for more than 20mm between the test leads.
8. This device is designed for indoor use only.
9. To prevent injury from sharp ends of the test leads, transport the device in the case provided.
10. Do not touch non-insulated test lead surfaces during measurements, it will affect the result. Keep fingers on the insulated surfaces of the handles.
11. Replacement of the battery must be carried out by a specialist. Batteries must be recycled or disposed of separately from regular household waste. Do not burn the battery.

6 Device Controls

The device is controlled by a 4-way joystick. Joystick functions are different when it is held for 1, or 2 beeps. Figure below shows the joystick location on the housing with arrows indicating the push directions and the number of beeps required to call the function.



The arrows show the direction of the joystick push. A single arrow denotes holding for one beep, two arrow heads denote holding for two beeps before releasing.

6.1 Turning on the Device

Press the joystick and hold for 1 beep.

6.2 Turning Off the Device

1. The device will turn off in the following cases:
2. Press the joystick and hold it until the display shows "Shutdown".
3. Hold with screen faced down for 3 beeps (may be disabled via the menu).
4. The device turns off if it has been inactive for 120 seconds (default). The automatic turn-off time setting can be changed in the menu: *System /Power/Time Off*
5. If you rotate and hold the device the screen will flip orientation to the hand being used.

6.3 Controlling Device Using Its Orientation

1. If you rotate and hold the device the screen will flip orientation to the hand being used. *
2. If you place the device on a flat surface with the screen facing up, after a few seconds the device will go into

Economy mode. The display shows the battery voltage and the firmware version. *

- If you place the device on a flat surface with the screen down, after 3 beeps the device will automatically turn off. *

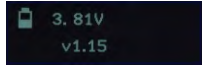

*Function can be enabled/disabled through the device menu: *System/Power*

6.4 Charging the Battery

The device is powered by a Li-Po battery with 3.7 V rated voltage. The battery icon on the display shows the remaining charge of the battery. This icon will blink when the device's power is below 3.6 V and will automatically turn off at 3.5 V. Information about the battery voltage can be displayed by selecting: *System/Power/Battery Voltage*

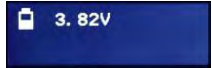

⚠ Charge the battery by connecting it via a micro-USB cable to a USB DC voltage source of 5V +/- 5%. The device screen is lit when the device is charging, and it turns off when the charging is complete.

6.5 Main and System Menu

The main menu is shown when the joystick is pressed. The main menu is multi-levelled. Select the appropriate menu item by moving the joystick up or down and pressing down to select. To set the default operating mode (R-L-C-D, RDC+LED, Voltage, etc.), press and hold the joystick for two beeps. This mode is then stored in the device memory and will be activated when the device is powered on next time.

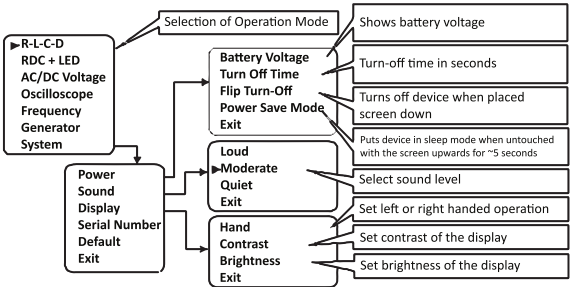

7 Modes of Operation

7.1 R-L-C-D Mode

R-L-C-D mode is the default device mode and it is designated for measurement of Resistors, Capacitors, Inductances and Diodes. To select the mode, select R-L-C-D in the main menu. In order to get access to the mode parameters (hidden sub-menu) push the joystick to the right for one beep. A typical screen for R-L-C-D mode looks as follows:

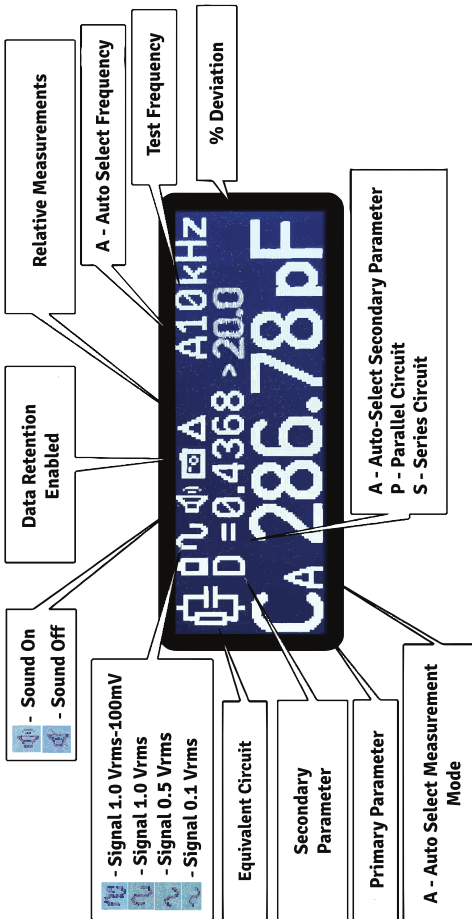

7.1.1 Measurements

When the measured component is connected to the test leads, the screen displays information depending on the component and the selected settings in the R-L-C-D mode menu.



Inductance



Capacitance



Resistance



Diode

In automatic mode, measurement of capacitance larger than 0.9 μF by default is made at 120 Hz, while ESR is measured at 100



kHz. In this case the display looks as follows. The frequency is not shown on the screen, but two

additional numbers are displayed indicating the capacitor parameters described below.

The main criterion for rejection of electrolytic capacitors is the value of ESR that varies amongst the types of capacitors and manufacturers. Two ESR tables have been compiled with typical ESR values for various capacitances/voltages, one for regular electrolytic capacitors and the other for Low ESR capacitors (presented below in Supplement A and B). These are indicative values and should only be used for a rough estimation of the capacitor performance. In this case besides the measured ESR value, two additional numbers are displayed in the right top portion of the screen. The first number indicates quality of the capacitor measured as a $\ln(R_s/R_t)$ where R_s is the measured ESR value and R_t is the value from the table. For standard aluminum capacitors a positive number indicate rejection, and for **Low ESR** values above -10. The 2nd number is the selected operating voltage of the capacitor. It should be specified in the menu item **Large Cap/C-voltage**. It should also be kept in mind that the measured capacitance may be significantly lower than the original data from the data sheet due to evaporation of the electrolyte and other degradation mechanisms. In such cases the table cannot be used for accurate capacitor evaluation.

If you wish to measure capacitance larger than 0.9 μF at a specific frequency you have to adjust frequency by pushing the joystick to the left for one beep or select frequency in the R-L-C-D parameter sub-menu by pushing the joystick to the right for one beep to activate the hidden sub-menu. In this case both the

capacitance and the secondary parameter (ESR or D) are measured at the same selected frequency.

 *Discharge Capacitor!*

7.1.2 Quick Controls

- Push the joystick up and hold for 1 beep to change the primary impedance type (more info below, Section 7.2.1)
- Push the joystick to the right and hold for 2 beeps to make Open/Short calibration and eliminate the offsets.
- Push the joystick left and hold for 1 beep to change the test frequency. The frequency changes cyclically Auto-100Hz-120Hz-1kHz-10kHz-100kHz. If the frequency is selected from the menu in the range 20-75kHz, the frequency changes cyclically 20kHz-30kHz-40kHz-50kHz-60kHz-75kHz-100kHz
- Push the joystick down and hold for 1 beep to change the test signal level cyclically Auto-1.0-0.5-0.1 Vrms



7.1.3 Relative (Tolerance) Measurements

In order to initiate Relative (Tolerance) measurement mode, connect the measured reference component to the probes, push the joystick up and hold for 2 beeps. The reference value will be recorded, and further measurements will show the measured value as well as the percentage deviation from the reference value. To cancel Relative measurements, push the joystick down for two beeps.

7.1.4 Open/Short Calibration

Before the first use, the device must be calibrated with Open and Short probes for both RDC+LED (for a correct diode parameter extraction) and R-L-C-D mode for each test frequency. When the device is set to Auto-frequency the device is automatically calibrated at 100Hz, 120 Hz, 1 kHz, 10kHz, and 100kHz.

If the probes are shorted, parasitic resistance is obtained. If the probes are open, parasitic capacitance is obtained. Please use LCR-Reader Capacitance Calibration Board to set a proper distance between the test leads for Open circuit calibration (according to the component size) because the parasitic capacitance depends on the distance between the test leads. Short circuit calibration is very crucial for small resistance and inductance and large capacitance. Open circuit calibration is crucial for small capacitance and large resistance.

To eliminate the offset, push the joystick to the right, hold for 2 beeps and release. When measuring small capacitances less than 100 pF, use LCR-Reader Offset Calibration Board included in the package for the open calibration. Insert the test leads at the

distance of the size of the component and calibrate with open probes. Only then measure the capacitor.

Before measuring small inductances (less than 10 μH) and resistances (less than 10 Ω) wipe off the tips of any dirt and oxides and calibrate with short probes.

7.1.5 Capacitance Offset Calibration Board

The Capacitance Offset Calibration Board provides a reliable method of determining the parasitic offset between the test leads. The dummy PCB uses holes to represent various sizes of components.

To use the calibration board, place the test leads into the holes corresponding to the size of component under test; make open



calibration by pushing the joystick to the right, hold for 2 beeps and release.

7.2 R-L-C-D mode menu

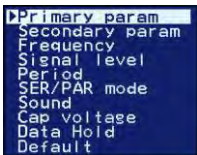

To open the hidden R-L-C-D mode settings push the joystick to the right and hold for 1 beep, the following menu will appear. The menu tree is shown in detail in the following diagram:

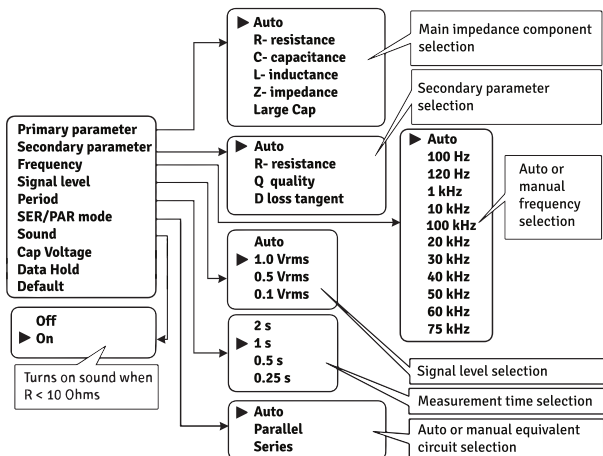

7.2.1 Primary Parameter

In Auto mode the type of measured component is determined automatically: R: Resistor, L: Inductance, C: Capacitor, D: Diode.

In addition to the component type selection test signal level is also adjusted when in-circuit measurements are made (see below 7.2.4). Measurement mode can also be set manually to R, L, C, Z and Large Cap. The last mode is only for measuring capacitance values larger than 0.5 μF (see section 7.2.10 below).

7.2.2 Secondary Parameter

In Auto mode for inductors quality Q factor is displayed for $Q > 1$ and series Resistance R_s for $Q < 1$, and for capacitors, loss tangent for $C < 0.5 \mu\text{F}$ and ESR for $C > 0.5 \mu\text{F}$. Automatic secondary parameter selection does not work if the Test Signal is set to Auto, R_s or R_p are used as the secondary parameter in this case.

7.2.3 Test Frequency

This menu item allows to manually select the frequency of the test signal. In Auto mode, the device automatically selects a frequency of 100Hz, 1 kHz or 10 kHz, depending on the rating and type of the component. For electrolytic capacitors 120 Hz is used for capacitance measurements and 100kHz for ESR. Users can also manually select the test frequency. A higher frequency should be used for measuring small values of capacitances and inductances as well as ESR. Lower frequencies are used to measure large inductance and capacitance values. Resistance measurements are always made at 1 kHz unless **RDC+LED** mode is selected.

7.2.4 Test Signal Level

For more stable readings, select 1.0 V_{rms} or Auto signal level. Auto is best for measuring loose components and in-circuit measurements of R, C, L. When measuring a component on a PCB, high test signal may open p-n junctions of semiconductor components. This, in turn, may cause error in the measurements. In order to avoid effect of the p-n

junctions, the signal level is automatically reduced to 0.1 V peak-to-peak and the impedance is re-measured. In this case, the screen shows the diode symbol and the direction of the p-n junction as shown below.



7.2.5 Period

Increased measurement time results in more stable readings, reduced time results in faster updates on the screen.

7.2.6 SER/PAR Mode

This is used to select the equivalent circuit depending on the characteristics of the element. For Capacitance measurements in Automatic equivalent circuit regime and Auto signal level Serial circuit is used for impedance values lower than 100 Ohms. If signal level is not in the Auto regime, serial equivalent circuit is

used for impedance values lower than 1 kOhm. For inductance only serial mode is used unless parallel mode is explicitly specified.

7.2.7 Sound

The device will beep when the resistance is less than 10 Ω , or a short circuit is found.

7.2.8 Cap-Voltage

This setting must be selected in the menu when evaluating electrolytic capacitors for rejection by ESR value. The

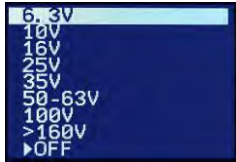

voltage value should be taken from the capacitor's housing. If OFF is selected, the capacitor parameters such as the capacitor quality according to the table and nominal voltage will not be shown on the display

7.2.9 Sample Hold

When selected, the device will hold measurement data on the screen. A beep will sound when the measurement is made, and the values are held on the screen after the component has been disconnected from the device. The device will only reset when a new component is measured, or the test probes are shorted.

In order to set a default measurement mode that will be activated when the device is turned on next time, select the mode, press the joystick and hold for 2 beeps. This measurement setting will be stored in the device's non-volatile memory for all other measurements until selecting other parameters or Default in the menu.

7.2.10 Default

By selecting Default, the R-L-C-D mode parameters are reset to:

- Primary Parameter is Auto
- Secondary Parameter is Auto
- Frequency is Auto
- Signal Level - 1.0 Vrms
- Measurement Time: 0.5 seconds
- Equivalent Scheme is Auto
- Sound is On
- C-voltage is Off
- Data Hold is Off

If you hold the joystick up to 2 beeps, then all parameters are stored in the non-volatile memory and will be loaded when the device is powered on.

7.2.11 Large Cap

In this mode, there are two sub-modes, one for capacitance values from 0.5 μF to 40 mF and the other from 40 mF to 1 F. In the first mode the capacitance is measured at a frequency of 120 Hz, and the capacitor's ESR is measured at the frequency of 100 kHz. The other mode is for capacitance values from 40 mF to 1 F and the capacitance is measured using DC while ESR is still measured at 100 kHz. To toggle between the modes, push the joystick left for 1 beep.



ESR=0.2167 Ω -05 16
C 401.06 μF

Discharge Capacitor!

Before the first application in this sub-mode it is necessary to additionally calibrate the device with both open and shorted probes.

For the rejection of electrolytic capacitors based on ESR, two tables are stored in the memory of the device, one for standard aluminum capacitors and the other for **Low ESR** capacitors (Supplement C and D, Section 14.2 and 14.3). Two additional numbers are displayed at the top-right corner of the screen in this case: the first number is the quality of the capacitor. For standard aluminum capacitors, positive values indicate rejection, and for **Low ESR** rejected values are above -10. The second number is the selected operating voltage of the capacitor in menu under C voltage: 6.3, 10, 16, 20, 30, 50-63, 100, and 160+ Volts.



ESR=0.2167 Ω -05 16
C 401.06 μF



CALIBRATION
OPEN

7.2.12 Large Cap (0.5 μF to 40 mF) Settings

- Push Joystick right for 2 beeps to make calibration eliminating the offset. Only short calibration is required.
- Push Joystick to the left to toggle between lower than 40 mF and higher than 40 mF capacitance measurements. To speed up the settling of the readings, short the capacitor leads for 2-3 seconds before the measurements.
- Push Joystick down for 1 beep to toggle the test signal level between 1.0 Vrms and 0.1 Vrms



ESR=335.74k Ω
C < 0.50 μF

7.2.13 Super Large Cap > 40 mF Measurement

- Push Joystick right for 2 beeps to make calibration eliminating the offset. Only short calibration is required.
- Push Joystick to the left to



ESR=526.07k Ω
C > 40.0 mF

toggle between lower than 40 mF and higher than 40 mF capacitance measurements. To speed up the settling of the readings, short the capacitor leads for 2-3 seconds before the measurements.

- Push Joystick down for 1 beep to toggle the test signal level between 1.0 Vrms and 0.1 V Vrms  *Discharge Capacitors*

7.3 RDC+LED Mode

This mode is designed to measure DC resistance, parameters of Diodes/LEDs, and diode leakage currents. Besides, it allows measuring a shunt resistor on a board that can be used for evaluating the current via that shunt in a live circuit.

- Press joystick to open the main menu, select RDC+LED mode and press the joystick again.
- Before making any measurement, push the joystick to the right for 2 beeps to calibrate with open and short probes to eliminate the offsets.

Four sub-modes can be selected: Auto, Diode, R test at 1.3 V DC, R test at 100 mV DC.

7.3.1 Auto Mode

To select the Auto Mode push the joystick down.

In the Auto mode resistances and diodes are automatically detected. For resistors the bottom line displays the resistance of the connected element, at the top the current I_r flowing through it. For diodes, the polarity of the diode, the voltage drop in the open state and the reverse current I_r are displayed.



7.3.2 Diode Mode

To select the Diode Mode push the joystick left. If you push left once again, the diode polarity reverses.

Diode mode is used for LED/diode parameter extraction using DC bias. It is recommended for in-circuit characterization of p-n junctions. The screen displays the voltage drop in the open state when the forward bias is applied. If the reverse bias is applied, OL is displayed instead. Push the joystick to the left and hold for 1 beep to change the polarity of the probes.



7.3.3 R test at 1.3 V and R test at 100mV

To select the R-test Mode push the joystick up, resistor symbol will be displayed in the top left corner. If you push up again, the

test voltage toggles between 1.3 and 0.1 Volts. The applied voltage is indicated by the pulse height in the top row of the screen.

These modes are used to measure DC resistance, recommended for in-circuit detection of resistors. It also allows measuring the selected shunt resistor on the board that could be later used for current measurements. In order to set the shunt resistor value, push the joystick down until 2 beeps while measuring the shunt resistor.



7.4 Voltage Mode

This mode is to measure DC and AC voltage. The device automatically detects the polarity of the DC voltage. The upper line of the display shows the values of the RMS voltage that is equal to the DC voltage for a DC bias. The second line shows the peak-to-peak voltage range which is zero for a DC bias.

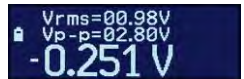

7.4.1 Controls

- Push Joystick up for 1 beep to toggle the current/voltage measurement mode.

In this mode, the voltage value measured on the shunt resistor is converted into a current and displayed on the screen. In the upper line of the screen the value of shunt resistance is displayed, taking into account the input resistance of the device, and the lower line shows the value of the current. To enter the resistance of the shunt into the device memory, go to the RDC+LED mode and select the 1.3 V mode. With the circuit de-energized, connect the shunt resistor and push the joystick down, hold for 2 beeps.



- Push the joystick to the left for 1 beep to turn on and off the capture mode of the maximum and minimum voltage values. In this mode the device continuously records and displays minimum and maximum values of the voltage/current as well as the instant value.



7.5 Transient Voltage Waveforms (Oscilloscope Mode)

In this mode, you can view the voltage waveform. On the right side of the screen, the horizontal scale (T / pixel), vertical scale (V / div), signal frequency and signal span are displayed.

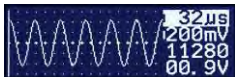

7.5.1 Oscilloscope mode settings

Usually automatic parameter settings are sufficient. The two parameters that can be adjusted manually are the time scale (T/pix) and the voltage scale (V/div).

- Push the joystick to the right for 1 beep to increase parameter.
- Push the joystick to the left for 1 beep to decrease parameter.
- Push the joystick up or down for 1 beep to select the parameter to change: T/pix or V/div.
- Push the joystick to the left for 2 beeps to automatic selection of T/pix (V/div).

7.6 Frequency Meter Mode

In this mode, it is possible to measure frequency, pulse duration, duty cycle, period and count the number of pulses.

7.6.1 Changing the sub-mode

Push the joystick to the right for 1 beep to open menu to select the desired sub-mode: frequency, period, counter, duty cycle and pulse duration. When the mode is selected, hold for 2 beeps to make it the default sub-mode for the Frequency meter.



7.6.2 Frequency, Period control

Push the joystick to the left for 1 beep to change the measurement time cyclically 0.25s-0.5s-1s-2s. Push the joystick to the right for 1 beep to return to the Frequency main menu.

Push the joystick to the left for 1 beep to reset the counter to 0. Push the joystick to the right for 1 beep to return to the Frequency main menu.



Push the joystick to the left for 1 beep to measure duration of a positive or negative pulse. Push the joystick to the right for 1 beep to return to the Frequency main menu.



Push the joystick to the right for 1 beep to return to the Frequency



main menu.

7.7 Signal Generator Mode

Only Sine wave signal is generated.

The signal is applied to the device probes. It is possible to adjust the

span (peak-to-peak) of the signal from 0.1 to 3.0 V. Parameters are stored when exiting the mode. On the right of the screen the voltage span and the waveform icon are shown. The frequency in Hz is displayed in the center of the screen.



In this mode, the turn-off time is 4 times longer than the default in other modes. An external decoupling capacitor is required to supply a signal to an active circuit. It should be connected to the Blue probe. The Red probe is common, virtual ground. In this mode, the device does not turn-off by "flipping" and the function of automatic change of the display orientation (left/right hand) is disabled. It is recommended to use LCR-Reader Kelvin Probe Connector to simplify the device operation in this mode.

7.7.1 Controls

- Push the joystick to the left or right for 1 beep to select the item to change.
- Push the joystick up/down for 1 beep to increase/decrease the selected parameter.
- Push the joystick to the left for 2 beeps to reset the cursor to the initial position.

7.8 System Menu Entries

7.8.1 Power

Battery Voltage

Turn-off Time: Push joystick Up/Down to Increase/Decrease

Turn-Off Time

Flip Turn-off: Off/On/Exit

Power Save Mode: Off/On/Exit

Exit

7.8.2 Sound

Loud/Moderate/Quiet/Exit

7.8.3 Display

Hand: Right/Left/Auto/Exit

Brightness: Push joystick Up/Down to Increase/Decrease

Brightness

Backlight: Push joystick Up/Down to Increase/Decrease Backlight

Exit

7.8.4 Serial Number

Press joystick to displays Serial Number of the device and the Firmware version.

7.8.5 Default

The following settings are stored in the device EEPROM when Default is selected in the System Menu and the joystick is pressed:

- Primary Parameter Auto
- Secondary Parameter Auto
- Frequency Auto
- Signal Level 1.0 Vrms
- Measurement Period 0.5 s
- Equivalent Circuit Auto
- Sound On
- Data Hold Off
- Shutdown Time 120 s
- Wakeup Mode R-L-C-D
- RDC+LED Mode Auto
- Frequency Mode Frequency
- Frequency Measurement Time 1 s
- System Sound Medium
- All offsets are reset to zero

8 Device Troubleshooting

8.1 If the device does not turn on

- Push the joystick and hold it for 1 beep, then release it.
- Charge the battery.
- Contact the manufacturer for repair.

8.2 If there are no initial readings on the screen

- From the system menu, select Default.
- Clean the contacts and make open/short calibration with open and closed probes.
- Review this manual to find possible errors in operating the device.

8.3 Technical Support

Customers can contact customer support by phone +1-519-888-9906 or by e-mail support@LCR-Reader.com.

When contacting technical support, please provide the following information:

- Model number
- Software version number
- Serial number of the device
- Purchase Receipt

9 Maintenance

9.1 General care of the device

- Do not expose the device to water, it is not waterproof.
- Do not expose the display for a long period of time to direct sunlight.
- Use a soft cloth dampened with water to clean the outside surface and cleaning the LCD display.
- Do not use liquid solvents or detergents.

9.2 Repairs

If there is an unexpected measurement result, check the quality of the contact between the test leads of the device probes and the element being examined. Make sure you make the measurements correctly. Carry out the instrument diagnostics. Independent dismantling of the case, replacement of individual elements and circuits are not allowed. For a repair, please contact the manufacturer directly.

10 Storage Conditions

- Temperature and humidity during storage: -10 ° C to 50 ° C with relative humidity <80%.
- There should be no dust, acid and alkali vapours in the storage room.
- Recharge the built-in battery once every 6 months.

11 Transportation

All modes of transportation at ambient temperatures from -40 ° C to + 50 ° C. The device must be protected against precipitation and dust.

12 Warranty

Manufacturer warrants this product to be free from defects in materials and workmanship for a period of one (1) year from the shipment date. Manufacturer warrants the following items for ninety (90) days from the date of shipment: rechargeable batteries, disks and documentation. During the warranty period, the Manufacturer will, at its discretion, either repair or replace any product that proves to be defective. To exercise this warranty, write or call your local distributor. You will be given prompt assistance and return instructions. Please send the product with shipping prepaid to the indicated service facility. Repairs will be made and the product will be returned to you. Repaired or replaced products are warranted for the balance of the original warranty period, or ninety (90) days from the date of the repair.

This warranty does not cover the repair of any product whose serial number has been altered, defaced or removed. This warranty does not cover finishes (scratches on surface or screen), normal wear and tear, nor does it cover damage resulting from misuse, dirt, liquids, proximity or exposure of heat, accident, abuse, neglect, misapplication, operation outside of the environmental specifications, tampering, unreasonable use, service performed or attempted by unauthorized service centers, failure to provide reasonable and necessary maintenance.

This warranty does not apply to defects resulting from product modification without Manufacturer's express written consent, or misuse of any product or part. This warranty also does not apply to software, non-rechargeable batteries, damage from battery leakage, and improper polarity of the batteries or problems arising from normal tear and wear or failure to follow instructions. This warranty does not cover LCD damage, physical damage to the Joystick; electrical damage of the product due to high voltage / charged capacitor or improper battery type. The design and

implementation of any circuit based on this product is the sole responsibility of the customer.

Manufacturer does not warrant any damage that occurs as a result of the user's circuit or any defects that result from user-supplied products. This warranty does not apply to repairs or replacements necessitated by any cause beyond the control of factory including, but not limited to, operation contrary to furnished instructions, shipping accidents, modification or repair by the user, neglect, accidents or other Acts of God. The foregoing is in lieu of all other expressed warranties and the Manufacturer does not assume or authorize any party to assume for it any obligation or liability. The duration of any warranties that may be implied by law (including the warranties of merchantability and fitness) is limited to the term of this warranty. In no event shall the Manufacturer be liable for special, incidental or consequential damages arising from ownership or use of this product, or for any delay in the performance of its obligations under this warranty due to causes beyond its control. This warranty is limited in duration to one (1) year from the date of original purchase. This warranty is in lieu of all other warranties, expressed or implied, including any implied warranty of merchantability or fitness for a particular use. The remedies provided herein are buyer's sole and exclusive remedies. Neither Manufacturer, nor any of its employees shall be liable for any direct, indirect, special, incidental or consequential damages arising out of the use of its devices and software even if Manufacturer has been advised in advance of the possibility of such damages. Such excluded damages shall include but are not limited to: costs of removal and installation, losses sustained as the result of injury to any person, or damage to property.

13 Specifications

The limits of the absolute error are given as \pm (% of the measured value + the number of LSB digits) at 23°C \pm 5°C, humidity less than 80% and 15 minutes of operation.

13.1 Overview

R-L-C		
Measurement Parameters	C+R, L+R, R, C+D, C+ESR, L+Q, Z+ θ	
Measuring Time	0.25 s, 0.5 s, 1.0 s, 2.0 s	
Test Signal Generator	Frequency	100,120 Hz, 1, 10, 20, 30, 40, 50, 60, 75, 100 kHz
	Voltage	1.0, 0.5, 0.1 Vrms
	Source Resistance	100 Ω
Resistance (R)	Range	10 m Ω to 20 M Ω
	Maximum Resolution	0.0001 Ω
Capacitance (C)	Range	0.1 pF to 1 F
	Maximum Resolution	0.001 pF
Inductance (L)	Range	10 nH to 100 H
	Maximum Resolution	0.1 nH
Quality Factor (Q)	0.001 to 1000	
Loss Tangent (D)	0.001 to 1000	
Loss Angle (θ)	-90 to 90°	
LED/Diode		
Maximum Voltage Test	3.2 V	
Voltage Measurement Accuracy	$\pm(3\%+5)$ V	
Maximum Test Current	16 mA	
Current Measurement Accuracy	$\pm(3\%+5)$ A	
Voltage		
Range	- 15 V to 15 V	

Maximum Resolution (DC)	1 mV
Input	DC+AC
Input Impedance	10 M Ω
Frequency	
Frequency	25 Hz – 100 kHz
Measuring Time	0.25 s, 0.5 s, 1s, 2s
Maximum Resolution	0.0001 Hz
Sensitivity	0.25 V
Accuracy	$\pm(0.005\%+5)$ Hz
Input Impedance	10 M Ω
Signal Generator	
Waveform	Sine
Maximum Frequency	100 kHz

13.2 FCC Compliance

Complies with ICES-003 Issue 6 and FCC Part 15.109. ETC Report produced by MPB Technologies No.: s57e17a242 Release 1 of August 30, 2017.

13.3 General Information

Type of Indicator	Monochrome graphic LCD display with backlight	
Power	Battery	Lithium-Polymer (Li-Poli) 3.7 V 250 mAh
	Typical Recharge Time	3 hours
	Continuous Use Time	Over 7 hours (without backlight)
	Auto-off	10 - 990 seconds (default 120s)
Use Conditions	10 - 40°C and relative humidity up to 80%	
Dimensions	Device	166x23x14 mm
	Case	180x40x20 mm
Unit Weight	39 g (1.35 Oz)	
Weight of the Device and Case	105 g (3.6 Oz)	

13.4 Details of the Measurement Modes

13.4.1 Test Signal Generator

Test Frequency	100, 120 Hz, 1, 10, 20, 30, 40,50, 60, 75, 100 kHz	DC Voltage
Frequency Accuracy	0.005%	-
Test Signal Level	1.0 \pm 0.05 Vrms, 0.5 \pm 0.02 Vrms, 0.1 \pm 0.01 Vrms, 0.1 \pm 0.01 V*	\pm 1.3 \pm 0.1, \pm 3.2 \pm 0.1, 0.1 \pm 0.01 V
Source Impedance	100 Ω 5%	

*Automatically set signal level for in-circuit measurement, lower accuracy 10% + 5.

13.4.2 Resistance

Test signal 1.0 Vrms

Range	Resolution	Test frequency				Equivalent Circuit
		100Hz, 120Hz	1kHz	10kHz	20kHz-100kHz	
10 Ω	0.001 Ω	0.5%+20	0.2%+20	0.5%+20	1%+20	Series
100 Ω	0.01 Ω	0.1%+3	0.1%+3	0.1%+3	0.5%+3	Series
1k Ω	0.1 Ω	0.1%+3	0.1%+3	0.1%+3	0.2%+3	Series
10k Ω	0.001k Ω	0.1%+3	0.1%+3	0.1%+3	0.2%+3	Series, Parallel
100k Ω	0.01 k Ω	0.1%+3	0.1%+3	0.1%+3	0.5%+3	Parallel
1M Ω	0.1k Ω	0.2%+3	0.2%+3	0.2%+3	1%+3	Parallel
10M Ω	0.001M Ω	1%+5	0.5%+5	1%+5	-	Parallel
20M Ω	0.01M Ω	3%+5	3%+5	-	-	Parallel

Test signal 0.5 Vrms and 0.1 Vrms

Range	Resolution	Test signal		Equivalent Circuit
		0.5Vrms	0.1Vrms	
10Ω	0.001Ω	5%+20	5%+20	Series
100Ω	0.01Ω	1%+3	1%+3	Series
1kΩ	0.1Ω	0.2%+3	0.5%+3	Series
10kΩ	0.001kΩ	0.2%+3	0.2%+3	Series, Parallel
100kΩ	0.01kΩ	0.2%+3	0.2%+3	Parallel
1MΩ	0.1kΩ	0.5%+3	0.5%+3	Parallel
10MΩ	0.001MΩ	2%+5	5%+5	Parallel
20MΩ	0.01MΩ	5%+5	5%+5	Parallel

- Calibrate with short and open test leads before measurement
- If D exceeds 0.1 then multiply the result by $\sqrt{1+D^2}$
- Measurement time 1 sec

13.4.3 DC Resistance

Test signal 1.3B

Range	Resolution	Accuracy
10Ω	0.001Ω	0.5%+20
100Ω	0.01Ω	0.3%+3
1kΩ	0.1Ω	0.1%+2
10kΩ	0.001kΩ	0.1%+2
100kΩ	0.01kΩ	0.2%+2
1MΩ	0.1kΩ	0.2%+3
10MΩ	0.001MΩ	0.5%+5
20MΩ	0.01MΩ	3%+5

- Calibrate with short and open test leads before measurement

13.4.4 Capacitance

Test signal 1.0 Vrms

Range	Resolution	Test frequency				
		100Hz, 120Hz	1kHz	10kHz	20kHz-75kHz	100kHz
10 pF	0.001pF	-	-	0.5%+5	-	1%+50
100pF	0.01pF	-	-	0.3%+5	3%+5	0.3%+5
1000pF	0.1pF	4%+5	0.3%+3	0.2%+5	1%+5	0.2%+2
10nF	0.001nF	0.2%+4	0.2%+3	0.1%+3	0.5%+2	0.5%+2
100 nF	0.01nF	0.2%+2	0.1%+3	0.1%+3	0.5 %+2	0.5%+2
1000nF	0.1nF	0.2%+2	0.1%+3	0.2%+3	1 %+3	2%+3
10μF	0.001 μF	0.3%+2	0.2%+3	0.2%+3	3 %+5	3%+5
100μF	0.01μF	0.5%+2	0.2%+3	3%+5	-	-
1000μF	0.1μF	2%+5	3%+5	-	-	-
10mF	0.01 mF	5%+5	-	-	-	-
40mF	0.01 mF	10%+5	-	-	-	-

Test signal 0.5 Vrms and 0.1 Vrms

Range	Resolution	Test signal	
		0.5Vrms	0.1Vrms
10pF	0.001pF	5%+200	-
100pF	0.01pF	3%+100	5%+200
1000pF	0.1pF	1%+10	3%+20
10nF	0.001nF	0.5%+3	2%+5
100nF	0.01nF	0.5%+3	2%+3
1000nF	0.1nF	0.5%+3	2%+3
10μF	0.001μF	1%+3	2%+3
100 μF	0.01μF	1%+3	2%+3

1000μF	0.1μF	1%+3	2%+5
10mF	0.001mF	2%+5	-

- Calibrate with short and open probes using LCR-Reader Offset Calibration Board with a proper component size.
- If D exceeds 0.1 multiply the result by $\sqrt{1+D^2}$
- Capacitance measurements are performed at automatic selection of the equivalent circuit, test signal 1 Vrms or 0.1 V peak-to-peak for in-circuit measurement.
- Discharge capacitors before measurement.
- Measurement time 1 sec.

13.4.5 DC Capacitance Measurement

Range	Resolution	Accuracy
40-100 mF	0.01mF	5%+5
1000 mF	0.1mF	5%+5

 Discharge capacitors before measurement

13.4.6 Inductance

Test signal 1.0 Vrms

Range	Resolution	Test Frequency				
		100Hz, 120Hz	1kHz	10kHz	20kHz-75kHz	100kHz
1000 nH	0.1nH	-	-	-	-	3%+5
10μH	0.001μH	-	-	0.5%+30	2%+30	3%+2
100μH	0.01μH	-	-	0.3%+5	0.5%+5	2%+3
1000μH	0.1μH	-	1%+3	0.2%+3	0.5%+2	1%+2
10 mH	0.001mH	0.2%+3	0.2%+3	0.2%+3	0.5%+2	1%+2
100mH	0.01mH	0.2%+3	0.2%+3	0.2%+3	0.5%+2	2%+3
1000mH	0.1mH	0.2%+3	1.0%+3	0.3%+3	3%+5	-
10H	0.001H	2%+3	2%+2	2%+3	-	-
100H	0.01H	5%+3	5%+3	-	-	-

Test signal 0.5 Vrms and 0.1 Vrms

Range	Resolution	Test signal	
		0.5Vrms	0.1Vrms
10μH	0.001μH	3%+50	-
100μH	0.01μH	1%+5	5%+5
1000μH	0.1μH	1%+3	2%+3
10mH	0.001mH	1%+3	2%+3
100mH	0.01mH	1%+3	2%+3
1000mH	0.1mH	2%+3	5%+5
10H	0.001H	5%+3	-

- Calibrate with short and open test leads before measurement
- If D exceeds 0.1 multiply the result by $\sqrt{1+D^2}$
- Inductance measurements are performed at automatic selection of the equivalent circuit, test signal 1.0 Vrms or 0.1 V peak-to-peak for in-circuit measurement.
- Measurement time 1 sec.

13.4.7 DC Voltage

Range	Resolution	Accuracy
10 V	0.001 V	0.5%+3
15 V	0.01 V	0.5%+3

- Presence of the AC will result in lower accuracy

13.4.8 AC Voltage

Range	Resolution	Accuracy	Frequency
0.1 -15 V	0.01 V	5%+3	30 - 3000 Hz

- Presence of the DC offset will result in lower accuracy

13.4.9 Low Frequency DDS Signal Generator

Sine Wave	20 Hz-100 kHz
Frequency Adjustment Step	0.1 Hz
Maximum Number of Samples Per Channel	512
Maximum Output Level (peak-peak)	3.0 V
Output Voltage Step	0.1 V
DAC	12 bit
Amplitude Accuracy	± (5% of the set level plus 0.02 V)
Maximum sampling frequency	1.5 MHz
Frequency Accuracy	Better than 0.02%
Source Impedance	100 Ω

We reserve the right to adjust specifications without prior notice

13.5 Supplement A

ESR rejection table for standard aluminum capacitors stored in the device memory

Cap μF	Volts							
	6.3	10	16	25	35	50-63	100	>160
1.0	-	-	-	-	-	142	118	74
2.2	-	-	-	-	-	64	54	34
3.3	-	-	-	-	-	43	36	22
4.7	-	-	-	-	-	30	25	16
6.8	-	-	-	-	-	21	17	11
10	-	-	-	-	-	14	12	7.4
22	-	-	-	-	-	6.5	5.4	3.4
33	-	-	-	-	5	4.3	3.6	2.2
47	-	-	-	4	3.5	3.0	2.5	1.7
68	-	-	3.5	2.7	2.4	2.1	1.7	1.1
100	-	2.9	2.4	1.9	1.7	1.4	1.2	0.75
150	-	1.9	1.6	1.3	1.1	0.95	0.79	0.49
220	1.5	1.3	1.1	0.86	0.75	0.65	0.54	0.34
270	1.2	1.1	0.88	0.7	0.61	0.53	0.44	0.27
330	1.0	0.86	0.72	0.57	0.50	0.43	0.36	0.22
470	0.71	0.61	0.50	0.40	0.35	0.30	0.25	0.16
560	0.59	0.51	0.42	0.34	0.30	0.25	0.21	0.13
680	0.49	0.42	0.35	0.28	0.24	0.21	0.17	-
1000	0.33	0.29	0.24	0.19	0.17	0.14	0.12	-
1500	0.22	0.19	0.16	0.13	0.11	0.09	-	-
2200	0.16	0.14	0.12	0.10	0.09	0.08	-	-
3300	0.11	0.10	0.09	0.07	0.08	0.06	-	-
4700	0.09	0.08	0.07	0.06	0.06	0.05	-	-
6800	-	0.06	0.05	0.05	0.05	-	-	-
8200	-	0.06	0.05	0.04	-	-	-	-
10000	-	0.05	0.04	0.04	-	-	-	-

13.6 Supplement B

ESR rejection table for Low ESR capacitors stored in the device memory

Cap μF	Volts						
	6.3	10	16	25	35	50	100
1.0	-	-	-	-	-	4.0	3.7
2.2	-	-	-	-	-	2.4	2.3
3.3	-	-	-	-	-	2.0	1.9
4.7	-	-	-	-	-	1.7	1.6
10	-	-	-	-	-	1.33	1.25
22	-	-	-	-	-	0.73	0.68
33	-	-	-	0.67	0.64	0.56	0.32
47	-	-	0.57	0.54	0.51	0.45	0.25
100	0.60	0.48	0.37	0.35	0.33	0.29	0.16
220	0.31	0.25	0.19	0.18	0.13	0.11	0.085
330	0.25	0.17	0.15	0.11	0.10	0.091	0.068
470	0.18	0.14	0.093	0.088	0.084	0.074	-
1000	0.066	0.063	0.060	0.057	0.054	0.048	-
2200	0.038	0.036	0.034	0.032	0.031	0.027	-
3300	0.032	0.030	0.029	0.027	0.026	-	-
4700	0.027	0.025	0.024	0.023	-	-	-
6800	0.024	0.023	0.022	-	-	-	-
10000	0.021	0.020	-	-	-	-	-
15000	0.020	-	-	-	-	-	-

LCR-Reader-MPA

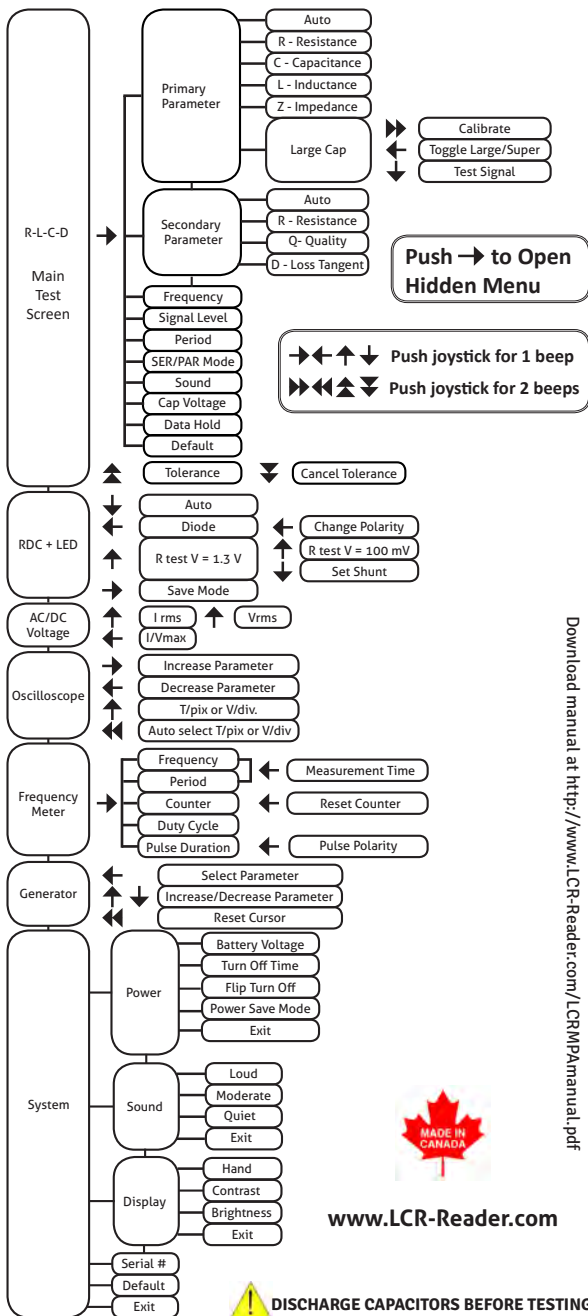

Siborg Systems Inc. 24 Combermere Crescent, Waterloo, Ontario, Canada N2L 5B1 1-519-888-9906
 Download manual at <http://www.LCR-Reader.com/LCRMPAmanual.pdf>



www.LCR-Reader.com



DISCHARGE CAPACITORS BEFORE TESTING